

# Optimizing Airport Runway Performance by Managing Pavement Infrastructure

by

Samantha Theresa Pinto

A thesis  
presented to the University of Waterloo  
in fulfillment of the  
thesis requirement for the degree of  
Master of Applied Science  
in  
Civil Engineering

Waterloo, Ontario, Canada, 2012

©Samantha Theresa Pinto 2012

## **Author's Declaration**

I hereby declare that I am the sole author of this thesis. This is a true copy of the thesis, including any required final revisions, as accepted by my examiners.

I understand that my thesis may be made electronically available to the public.

## **Abstract**

The research described herein is composed of four major areas of practice. It examines the overall performance of runways and provides tools designed to improve current runway operations and management with particular emphasis on contaminated surfaces.

Presented in this thesis is an overview of how to design airport pavements in order to achieve optimal friction by specifically focusing on material selection and construction techniques for rigid and flexible pavements. Rubber buildup and the impact rubber accumulation has on decreasing runway friction, particularly in a range of climatic conditions, is discussed. Four commonly used rubber removal techniques are presented and evaluated. Through this research, an analytical hierarchy process (AHP) decision making protocol was developed for incorporation into airport pavement management systems (APMS).

Runway surface condition reporting practices used at the Region of Waterloo International Airport are evaluated and recommendations for improving current practices are identified. Runway surface condition reporting can be improved by removing subjectivity, reporting conditions to pilots in real-time, standardizing terminology and measurement techniques, and including runway pictures or sketches to identify contaminant locations where possible. Reports should be incorporated and stored in the APMS.

Aircraft braking systems and their effects on landing distances under contaminated conditions are discussed. This thesis presents a proposed solution for monitoring and measuring contaminated runway surfaces and identifying the risks associated with aircraft landing through using the Braking Availability Tester (BAT). Also proposed in this thesis is a testing framework for validating the Braking Availability Tester. The proposed BAT measures interaction between aircraft antiskid braking systems and runway contaminants to determine landing distances more accurately.

Finally, this thesis includes a discussion explaining how pavement design, contaminant removal, results from friction tests, and results from the BAT can be incorporated into airport pavement management systems. APMS data can be analyzed to economically optimize and prioritize scheduling of pavement maintenance, preservation and rehabilitation treatments to maintain a high level of service, thereby contributing to runway safety and optimization.

## Acknowledgements

I would like to sincerely thank my graduate supervisor, Professor Susan Tighe of the Department of Civil and Environmental Engineering at the University of Waterloo for her guidance, advice, and support throughout my university career. I am truly fortunate to have a graduate supervisor who provides an academically challenging and stimulating learning environment, has high standards for her students and has always been a mentor and role model for my professional career development.

I would like to thank Professor Soo Jeon and Professor HJ Kwon, of the department of Mechanical and Mechatronics Engineering at the University of Waterloo for teaching me about aircraft braking systems and for providing valuable input regarding the operation of the Braking Availability Tester.

I would like to thank Paul Cudmore, Steve McKeown, Peter Kleinschmidt and the folks at Team Eagle, for providing me the opportunity to contribute to this very exciting and innovative Braking Availability Tester project. I learned a lot from the challenging and stimulating discussions we had during our weekly conference calls, and from participating in the assembly of the Braking Availability Tester. I am truly grateful to have been a part of this project. I thoroughly enjoyed helping build the BAT and I was privileged to work with a team of experienced and skilled leaders in aviation engineering and business management. I would also like to thank Arnie Beck and Sunsource Ltd. for providing guidance throughout this project.

I would like to thank Kevin Campbell from the Region of Waterloo Airport for his mentorship, and patience and diligence in teaching me about runway testing, reporting and airport operations. I really appreciate his unwavering encouragement of the BAT project, and his efforts to support my learning by explaining airport operations and practices. I would also like to thank the staff the Region of Waterloo International Airport for the wealth of information they have provided me in support of my thesis.

I would like to thank the Ontario Centres of Excellence for funding this research program. Additionally, I would like to thank the University of Waterloo and the Transport Association of Canada for awarding me with scholarship funding.

I would like to recognize the support I received from members of the Centre for Pavement and Transportation Technology and the co-op students that participated in the BAT Project. I would like to thank the Civil and Environmental Engineering Department, the Faculty of Engineering and the Graduate studies office for allowing me the opportunity to perform this research and pursue higher education.

I am blessed to have an amazing family and I would like to thank my Mom, my Dad and my four sisters Rebecca, Miranda, Ciara and Madeline. Thank you for encouraging me to read and teaching me how to write, for challenging me to think analytically and to see the opportunity when faced with a challenge. Your constant support, encouragement and faith in me enabled me to succeed. I would also like to thank my amazing friends, especially Jonathan Boyle and Attila Hertel, for making me laugh and reminding me to enjoy life.

## **Dedication**

I would like to dedicate this thesis to the people in my life who have encouraged me to realize my potential and dream big. I hope I will continue to make you proud.

As this two year journey culminates, I am overcome with excitement and joy to be writing the final words of my thesis on July 11, 2012; my grandmother's 83<sup>rd</sup> birthday. I would like to dedicate this thesis to my Granny, Sylvia da Cunha. Happy Birthday Granny!

And Miranda :)

## Table of Contents

Author’s Declaration.....	ii
Abstract.....	iii
Acknowledgements.....	iv
Dedication.....	v
Table of Contents.....	vi
List of Figures.....	xi
List of Tables.....	xii
Chapter 1 Introduction.....	1
1.1 Background.....	1
1.2 Scope.....	1
1.3 Objectives.....	2
1.4 Thesis Methodology.....	2
1.5 Acronyms and Units.....	3
Chapter 2 Literature Review.....	5
2.1 Canadian Runway Friction Index.....	5
2.1.1 History.....	5
2.1.2 CRFI Friction Testing Procedure.....	6
2.1.3 Application of the Index.....	6
2.1.4 Criteria for Collecting CRFI Measurements.....	10
2.2 Estimating Landing Distances Requirements.....	10
2.3 Pilot Reports.....	11
2.4 Takeoff and Landing Performance Assessment.....	14
2.5 Aircraft Landing.....	16
2.6 Case Study Aircraft: Boeing 737.....	18
2.7 Airport Pavement Design.....	19
2.7.1 Pavement Friction, Microtexture and Macrotecture.....	19
2.8 Pavement Management.....	21
2.9 Airport Operations.....	21
2.9.1 Snow and Ice Operations Plan.....	21

2.10 Friction Testing.....	22
2.11 Chapter Summary .....	23
2.11.1 Chapter Key Points .....	24
Chapter 3 Airport Pavement Design and Management .....	25
3.1 Goals in Runway Pavement Design .....	25
3.2 Incorporating Aircraft Factors in Design.....	25
3.2.1 Impact of Traffic.....	29
3.3 Flexible Pavement Design .....	30
3.3.1 Hot Mix Asphalt Surface .....	30
3.3.2 Flexible Pavement Base Course .....	32
3.3.3 Flexible Pavement Subbase .....	34
3.3.4 Flexible Pavement Subgrade .....	34
3.4 Rigid Runway Pavement Design .....	36
3.4.1 Rigid Pavement Surface .....	36
3.4.2 Rigid Pavement Subbase .....	36
3.5 Foreign Object Debris.....	37
3.6 Airport Pavement Management Systems (APMS).....	37
3.6.1 Key Features of an APMS .....	37
3.6.2 Advantages of using an APMS.....	38
3.6.3 Costs associated with an APMS .....	39
3.7 Chapter Summary .....	39
3.7.1 Chapter Key Points .....	39
Chapter 4 Rubber Contaminated Runways and Rubber Removal Techniques .....	40
4.1 Pavement Texture .....	40
4.2 Rubber Build up.....	40
4.3 Friction Testing to Measure the Impact of Rubber.....	41
4.3.1 State of Practice: Frequency of Friction Tests.....	41
4.3.2 State of Art: Frequency of Friction Tests .....	42
4.4 Rubber Removal .....	42
4.5 Rubber Removal by Chemical Agents .....	43

4.5.1 Application Rate and Cost of Chemical Agents.....	43
4.5.2 Advantages of Chemical Agents .....	43
4.5.3 Disadvantages of using Chemical Agents .....	44
4.6 Rubber Removal by Waterblasting .....	44
4.6.1 Processing Rate and Unit Cost of Rubber Removal by Waterblasting .....	44
4.6.2 Advantages of Waterblasting .....	45
4.6.3 Disadvantages of Waterblasting.....	46
4.7 High Velocity Impact Rubber Removal.....	46
4.7.1 Process Speed and Unit Cost of Shotblasting .....	47
4.7.2 Advantages of High Velocity Impact Rubber Removal.....	47
4.7.3 Disadvantages of High Velocity Impact Rubber Removal .....	47
4.8 Rubber Removal by Mechanical Means .....	48
4.9 Decision Making Using an Analytical Hierarchy Process .....	48
4.10 Applying the AHP to a Low Volume Airport.....	49
4.11 Sensitivity of Criteria Selection and Impact of Criteria Weights and Scores .....	51
4.11.1 Case Study: Application of the AHP Tool to a High Volume Airport.....	53
4.11.2 Case Study: Application of the AHP Tool to an Intermediate Volume Airport .....	54
4.11.3 Case Study: Application of the AHP Tool to a Low Volume Airport .....	55
4.11.4 Case Study: Application of the AHP Tool to a Military Airport .....	57
4.11.5 Summary of Case Studies .....	58
4.12 Chapter Summary.....	58
4.12.1 Chapter Key Points .....	59
Chapter 5 Improving Runway Condition Assessment and Reporting .....	60
5.1 Analysis of Runway Surface Condition Reports.....	60
5.1.1 Issue: Canadian Runway Friction Index Reporting Frequency.....	60
5.1.2 Issue: Discrepancy between CRFI Test Time and Reporting .....	60
5.1.3 Issue: Runway Cleared during Data Collection for the RSC Report .....	61
5.1.4 Issue: CRFI Data not collected when environmental conditions merit CRFI Tests.....	61
5.1.5 Issue: RSC Reports do not provide Context regarding Environmental Conditions .....	61
5.1.6 Issue: RSC Reports are only valid when the RSC survey is collected.....	62



5.1.7 Issue: Level of Detail in Data Collection Method .....	62
5.1.8 Issue: RSC reports do not Identify Contamination Location.....	63
5.1.9 Issue: Descriptions of Contaminants not Clearly Defined.....	64
5.1.10 Issue: Measurement of Contaminant Depth.....	65
5.1.11 Issue: Aviation Industry needs better Instrumentation and Measuring Tools .....	65
5.1.12 Issue: Pilot Reports are Subjective .....	67
5.2 Chapter Summary .....	68
5.2.1 Chapter Key Points.....	68
Chapter 6 Braking Availability Tester.....	69
6.1 Design of the Braking Availability Tester.....	69
6.2 Mechanical Design and Sensors Incorporated in the BAT .....	70
6.2.1 Thermocouples .....	70
6.2.2 Infrared Temperature Sensor .....	71
6.2.3 Pavement Temperature Sensor .....	72
6.2.4 Hydraulic Cylinder and Pressure Sensors.....	72
6.2.5 Load Cells.....	73
6.2.6 Speed Sensors .....	75
6.2.7 Proportional Valve and Solenoid.....	77
6.3 Antiskid Braking Algorithm .....	78
6.4 Framework for BAT Calibration Procedure .....	79
6.5 Key Testing Conditions .....	81
6.6 Anticipated Significance of the BAT .....	82
6.7 Chapter Summary .....	82
6.7.1 Chapter Key Points.....	83
Chapter 7 Conclusion and Recommendations .....	84
7.1 Key Findings from Literature Review .....	84
7.2 Finding from Review of Airport Pavement Design and Management .....	85
7.3 Rubber Removal Alternatives Summary .....	85
7.4 Runway Surface Condition Reporting Improvements.....	86
7.5 Role of the Braking Availability Tester and Proposed Framework for Calibration and Validation .....	86

7.6 Incorporating BAT Data into APMS and Runway Pavement Optimization.....	87
Appendix A Glossary of Terms .....	88
Appendix B Conversion Factors for Imperial to Metric Units.....	90
References.....	91

## List of Figures

Figure 1.1 – Overview of Proposed Methodology for Improved Flow of Information.....	3
Figure 2.1 - Cross wind limitations for CRFI [TC, 2010a] .....	8
Figure 2.2 - CRFI Expected Range of CRFIs by surface type [TC, 2010a] .....	9
Figure 2.3 - PIREP Form [FAA, 2012b] .....	12
Figure 2.4 - Illustration of glideslope and pilot instrumentation [Thales, 2007].....	17
Figure 2.5 - Illustration of pavement microtexture and macrotexture. [MTO, 2010] .....	20
Figure 3.1 – Two Effective Tire widths, no overlap [FAA, 2009a] .....	28
Figure 3.2 – One Effective Tire Width, With Overlap [FAA, 2009a].....	29
Figure 3.3 - Typical Plan and Cross Section for Runway Pavement [FAA, 2009a] .....	31
Figure 3.4 Pavement Condition Life Cycle [FAA, 2011a].....	38
Figure 4.1 - Rubber Buildup on a Runway [Bangkok, 2008].....	41
Figure 4.2 - Waterblasting Seasonality for Northern and Southern Airports from a Survey of North American Airports [ACRP, 2008b].....	46
Figure 5.1 - Illustration identifying location of runway contaminants .....	63
Figure 5.2 - Illustration of Impact of Wind Shear on Landing [Touring, 2008].....	66
Figure 5.3 – Comparison of Normal and Wind shear Landing [Touring, 2008].....	67
Figure 6.1 - Schematic illustration of the BAT .....	69
Figure 6.2 - Prototype Braking Availability Tester .....	70
Figure 6.3 - Configuration of Thermocouples in the BAT .....	71
Figure 6.4 – Hydraulic Cylinders and Pressure Sensors in the BAT .....	73
Figure 6.5 - Load Cell Configuration .....	74
Figure 6.6 - Sample Vertical load, Horizontal Load and Brake Torque.....	75
Figure 6.7 - BAT Wheel speed and GPS Speed (Sample data).....	76
Figure 6.8 - Proportional Valve and Hydraulic line at the BAT Wheel .....	77
Figure 6.9 – Proposed Pattern for Runway Testing the BAT .....	80
Figure 6.10 - Inputs for Determining Braking Availability .....	81

## List of Tables

Table 2.1 - CRFI Table 1, Landing distance without Discing/ Reverse Thrust [TC, 2010a].....	7
Table 2.2 CRFI Table 2, Landing distance with Discing/ Reverse Thrust [TC, 2010a] .....	7
Table 2.3 - Minimum and Maximum CRFI Limits by Surface Type [TC, 2010a].....	10
Table 2.4- Factors for Calculating Landing Distance [ACRP, 2008a] .....	11
Table 2.5 - How to Complete a PIREP [FAA, 2012b].....	13
Table 2.6 - Paved Runway Condition Assessment Table [Marchi, 2012] .....	15
Table 3.1- Airplane Gear Configuration and Naming Convention [FAA, 2009a].....	26
Table 3.2 – Pavement Remaining Life Based on CDF [FAA, 2009a].....	30
Table 3.3 - Suitable Base Course Materials for Flexible Pavement [FAA, 2009a] .....	32
Table 3.4 – Stabilized Subbase Layer Types in FAARFIELD [FAA, 2009a] .....	33
Table 3.5 - Minimum Aggregate Base Course Thickness for Flexible Pavements [FAA, 2009a] ..	33
Table 3.6 - Subbase Materials for Flexible Pavements [FAA, 2009a].....	34
Table 3.7- Subgrade Compaction Requirements [FAA, 2009a] .....	35
Table 3.8 - Rigid Pavement Subbase Materials [FAA, 2009a] .....	36
Table 3.9 – Stabilized Rigid Pavement Subbase Materials [FAA, 2009a] .....	37
Table 4.1 – Minimum Frequency for Friction Testing [AFCESA, 2004 and Speidel, 2002] .....	42
Table 4.2 – Reported Chemical Rubber Removal Unit Costs [after ACRP, 2008b] .....	43
Table 4.3 – Reported Waterblasting Rubber Removal Unit Costs [after ACRP, 2008b] .....	45
Table 4.4 – Reported Shotblasting Rubber Removal Unit Costs [after ACRP, 2008b].....	47
Table 4.5 - Decision Making Matrix for Selecting Rubber Removal Technique .....	48
Table 4.6 – Application of the AHP Decision Making Tool Example .....	50
Table 4.7 - Application of AHP Decision Making Tool to a High Volume Airport.....	53
Table 4.8 - Application of the AHP Decision Making Tool to an Intermediate Volume Airport....	54
Table 4.9 - Application of the AHP Decision Making Tool to a Low Volume Airport .....	56
Table 4.10 - Application of the AHP Decision Making Tool to a Military Airport.....	57
Table 4.11 - Summary of Scores for Rubber Removal Techniques.....	58
Table 5.1 – Summary of RSC Report Contaminant Descriptions and Reported Depths, Region of Waterloo International Airport November 2010- March 2012 .....	64
Table 6.1- Summary of Key Sensors and Components of the BAT .....	83

# Chapter 1

## Introduction

### 1.1 Background

On December 8, 2005, Southwest Airlines flight 1248 overran runway 31C at Chicago Midway Airport in Chicago, Illinois. The aircraft, a Boeing B-737-7H4, was guided using instrument meteorological conditions and overran the runway during the landing rollout. Prior to landing, the pilots received mixed information about the environmental conditions and potential braking action available on the runway [FAA, 2011b]. The pilots used the information provided to them by air traffic control and entered best and worst case scenarios into the aircraft's Onboard Performance computer to determine that without a factor of safety, they had enough space on the runway to safely land the aircraft.

In interviews following the accident, the pilots indicated they felt antiskid braking continually engaging and releasing the brakes during the landing rollout [FAA, 2011b]. The investigation following the accident at Chicago Midway Airport identified that landing distance and runway stopping performance should consider all factors that affect aircraft stopping capability. This particular accident was also the starting point for several regulatory changes in the Federal Aviation Administration's (FAA) rules for assessing and reporting runway conditions. It should be noted that there were also several other examples of overruns on runways due to similar circumstances.

Current runway friction testing practices do not account for the effect aircraft antiskid braking systems (ABS) have on increasing required braking distance when landing on a deformable contaminant. The Braking Availability Tester (BAT) is a runway measuring device being developed in partnership with Team Eagle Ltd., the Ontario Centres of Excellence, and the University of Waterloo Centre for Pavement and Transportation Technology (CPATT). The objective of the BAT is to provide the aviation industry with real time runway condition information, and a reliable measure of anticipated braking availability, especially in the presence of winter contaminants.

### 1.2 Scope

The scope of this thesis is to examine the key factors impacting an aircraft's ability to safely stop on a runway. This includes an analysis of the construction of both flexible and rigid runway surfaces, and the effect that rubber and contaminant accumulation have on runway friction. This thesis includes an analysis of runway pavement design best practices, required friction testing frequency, and runway surface condition reporting practiced by Canadian aerodromes and or airports. This thesis also investigates the BAT as a device that can be used to provide real-time measurement of braking availability. This thesis shows how runway data collection, real time data distribution and data analysis can be utilized to improve airport operations by incorporating this data into an airport pavement management system (APMS). This thesis also demonstrates how using an airport pavement management system will also lead to economically optimized maintenance and rehabilitation decisions, which also lead to improved runway safety and runway performance.

This thesis is primarily focused on best practices and regulations affecting Canadian and American airports located in a northern, winter climate. Where possible, runway data and current operational practices from the Region of Waterloo International Airport are included in the analysis.

### **1.3 Objectives**

The objectives of this thesis are to:

- Conduct a literature review to understand current industry practices.
- Review runway pavement design and management practices, focusing on the impact that pavement design and management have on pavement friction and runway performance.
- Present four methods for runway rubber removal and a decision making tool that airports can incorporate into their APMS for evaluating the best removal method.
- Review Runway Surface Condition Reports and provide recommendations that Transport Canada can employ in Canadian aerodromes to improve runway condition data collection and real time reporting to pilots.
- Introduce the BAT device and discuss how the BAT can be calibrated and utilized to provide pilots with expected runway braking availability.
- Discuss how the BAT can be used to provide information that can be incorporated in an APMS and used for making maintenance, preservation, and rehabilitation decisions that will extend pavement life and improve runway performance.

### **1.4 Thesis Methodology**

The first component of this thesis is a literature review that establishes the current state-of-practice in the aviation industry for measuring, reporting, and analyzing runway contaminants and their effects. Gaps identified in the literature are noted and addressed in subsequent chapters of this thesis.

The next topic covered is a review of current best practices for runway pavement design and construction. This thesis investigates both rigid and flexible pavement, as these surfaces are most commonly used in runway applications. Best practices for constructing runway pavement to achieve adequate friction are identified. The benefits and costs associated with implementing APMS, as well as the importance of proper training and use of management systems are discussed.

Rubber accumulation is a contaminant that reduces runway friction. Four techniques for removing rubber deposits are considered. The merits associated with each rubber removal alternative are identified and discussed. Typical costs associated with rubber are also included. This research includes an analytical hierarchy process decision making tool developed to incorporate rubber removal decisions into pavement management.

Runway monitoring and condition reporting is a fundamental element of airport pavement management. Runway surface condition reports from the Region of Waterloo are analyzed and areas for standardizing and improving state-of practice measuring and reporting are identified.

The final component of this research is introducing the BAT as a device that incorporates antiskid braking systems (ABS) in its measurement of runway conditions. A proposed framework for validating the BAT is discussed and key testing conditions are identified. The anticipated significance of the BAT as it pertains to aviation safety and pavement management are discussed.

A conceptual overview of this thesis is illustrated in Figure 1.1

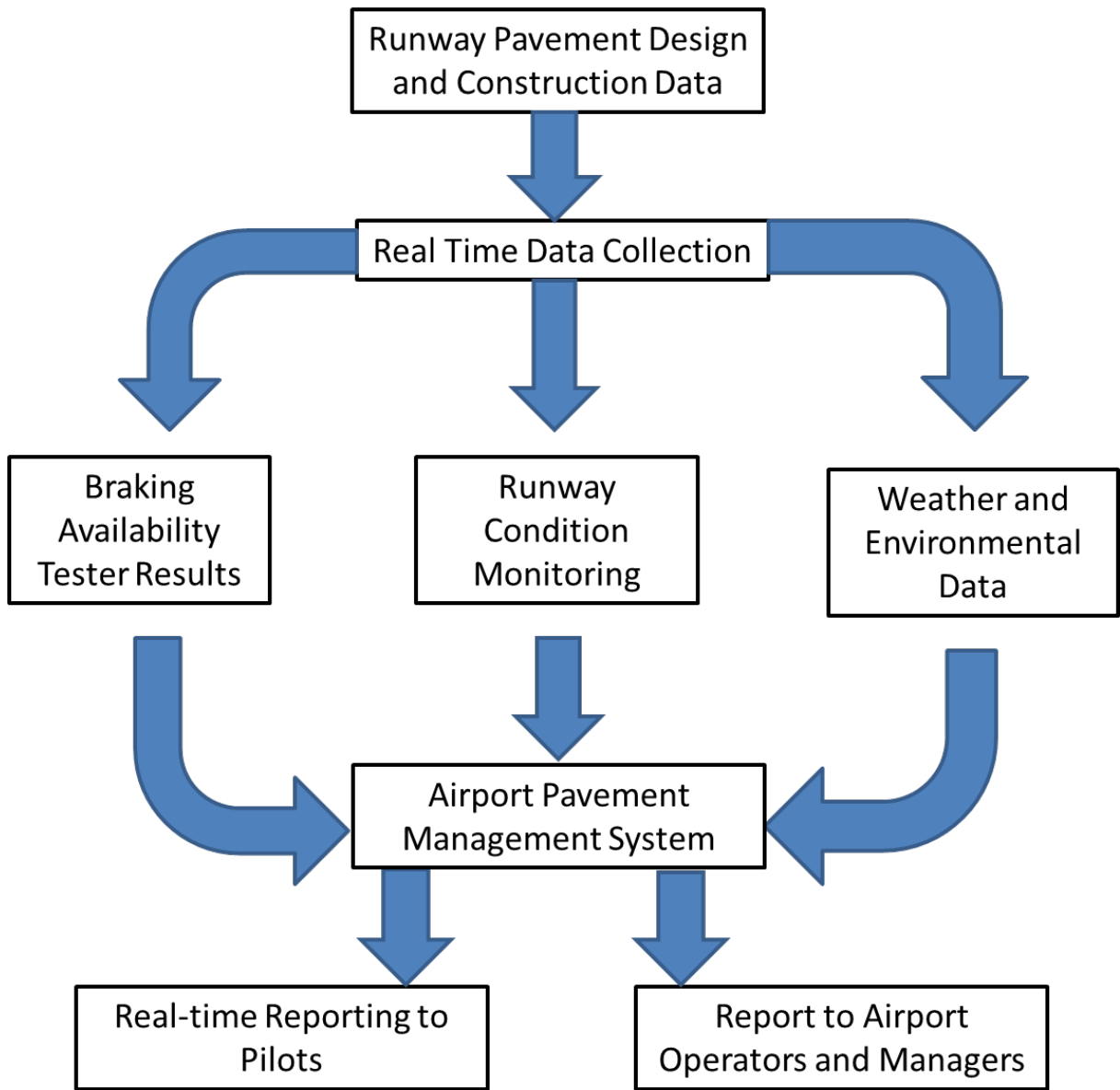

**Figure 1.1 – Overview of Proposed Methodology for Improved Flow of Information**

### 1.5 Acronyms and Units

Appendix A contains a glossary of acronyms for commonly used terminology used in aviation and throughout this thesis.

It should be noted that the Imperial System is internationally used for measurements in the aviation industry. Reports, policy and standards regarding aviation practices are generally all published with

Imperial units. This thesis includes several published tables and results from government and industry studies where the original measurement was provided in Imperial units. Metric conversions are included where reasonable throughout the thesis. Appendix B contains a list of common unit conversion factors.



## Chapter 2 Literature Review

### 2.1 Canadian Runway Friction Index

#### 2.1.1 History

The Canadian Runway Friction Index (CRFI) consists of a series of tables used by Canadian airports to estimate landing distances of aircrafts either with or without reverse thrust capabilities. The CRFI replaced the James Brake Index (JBI), an index developed based on tests conducted in Oslo, Norway, in 1954. The JBI was calibrated using a four-engine piston aircraft with speeds in the 75 knot range [TC, 1999]. After confusion over how to apply the JBI to current aircrafts with reverse thrust capabilities, the CRFI was developed.

The change in name from JBI to CRFI also reflects the variety of devices used to test runways. The JBI name was based on the James Brake Decelerometer (JBD), a device that went out of production in the mid 1970's. Current decelerometers used for CRFI inputs at Canadian airports that are comparable to the JBD are the Mechanical Tapely Meter, the Mechanical Bowmunk, the Electronic Recording Decelerometer, the Electronic Tapely Meter and the Electronic Bowmunk [TC, 1999]. The aforementioned devices are all compatible with the CRFI system in that they measure friction values that can be used as inputs in the CRFI tables.

The values for estimating the runway landing distances found in the current CRFI tables were obtained as a part of the Joint Winter Runway Friction Project (JWRFP). Initially the JWRFP was a collaborative program between Transport Canada (TC) and the National Aeronautics and Space Administration (NASA). It was created to investigate and better understand factors affecting aircraft braking on contaminated runways. By quantifying contamination drag and aircraft braking friction on various wet and winter contaminants, NASA and Transport Canada hoped to be able to more accurately estimate landing and take-off distances on contaminated runways [TC, 2010b]. Eventually, the US Federal Aviation Administration (FAA), National Research Council of Canada (NRC) and 30 international organizations from 12 countries joined the JWRFP [TC, 2010c].

The JWRFP test program included building a database of over 10,000 ground friction measurements and over 275 aircraft runs [TC, 2010c]. Tests were initially conducted at an airport in North Bay, Ontario, and then subsequently at a series of international locations including NASA Wallops Flight Facility in Wallops, Virginia; Oslo, Norway; Gwinn Sawyer Airbase, Michigan; Munich, Germany; Erding Army Airbase, Germany; and Prague, Czech Republic [TC, 2010c].

The focus of the JWRFP has been to develop an International Runway Friction Index (IRFI) to assist pilots in making critical landing and takeoff decisions. IRFI was developed from the database of information containing ground vehicle and aircraft friction measurements. The final objective of the JWRFP was to relate aircraft stopping performance to the IRFI and ground vehicle outputs [TC, 2008].

The CRFI coefficients were determined by plotting aircraft braking coefficients and acceleration data. The deceleration data was obtained using antiskid decelerometers on contaminated runways. The anticipated deceleration model was developed by using a linear fit model of braking coefficients

and CRFI. The deceleration from the model can be used to calculate the braking distance and the runway landing distance [TC, 2010c]. Additionally, factors such as altitude above sea level, tail wind speed and aircraft maximum gross weight are included in the landing distance calculation.

Using a Notice to Airmen (NOTAM), airport operators provide pilots with CRFI information whenever there is ice, frost, snow or winter contaminant on the runway that may affect the braking ability of the aircraft. A “NOTAMJ” is specifically issued to inform pilots of poor landing conditions on the runway.

### **2.1.2 CRFI Friction Testing Procedure**

The theoretical decelerating capability is measured using a decelerometer, an instrument mounted on a test vehicle that measures the decelerating forces acting on the vehicle when brakes are applied. The CRFI reading is an average of readings from brakes being applied on the test vehicle at 300 m intervals along the runway, within a distance of 10 m from the runway centreline [TC, 2012a].

### **2.1.3 Application of the Index**

The Canadian Runway Friction Index (CRFI) is a numerical index used to estimate aircraft landing distance requirements. The CRFI is an index with a series of graduated friction increments ranging from 0 to 1 that represent the decelerating capability of an aircraft on a runway. Small friction numbers represent low braking coefficients. For example, a CRFI value greater than 0.8 indicates the braking coefficient typical for bare and dry runways, and a CRFI value of 1 is the theoretical maximum decelerating capability of an aircraft on a dry surface [TC, 2012a].

CRFI tables were created based on data collected from over 300 aircraft test runs and nearly 40 000 runs with 44 different kinds of ground test vehicles [TC, 2012a]. Table 2.1 is the CRFI Recommended Landing Distances without Discing or Reverse Thrust. As noted, the CRFI friction value and recommended landing distance depend on the measured CRFI for an aircraft not using reverse thrust and discing to stop the plane [TC, 2012a]. Conversely, Table 2.2 is the CRFI Recommended Landing Distances with Discing and Reverse Thrust.

As Table 2.1 and Table 2.2 indicate, the landing distance required for runways with a lower CRFI number becomes much greater than the dry (unfactored) runway length. In cases where the CRFI friction number is low, the estimated landing length could be relayed to pilots using NOTAMs.

The recommended landing distances shown in Table 2.1 and Table 2.2 are conservative, developed based on runway tests. The landing distances are stated with a 95% confidence level, meaning 19 times out of 20 the factored landing distance is a conservative estimate of the actual distance required to land based on the runway friction and braking method used by the pilot [NAV Canada, 2011].

**Table 2.1 - CRFI Table 1, Landing distance without Discing/ Reverse Thrust [TC, 2010a]**

Reported Canadian Runway Friction Index (CRFI)														
Landing Distance (Feet) Bare and Dry Unfactored	0.60	0.55	0.50	0.45	0.40	0.35	0.30	0.27	0.25	0.22	0.20	0.18	Landing Field Length (Feet) Bare and Dry	Landing Field Length (Feet) Bare and Dry
	Recommended Landing Distances (Discing/Reverse Thrust)												60% Factor	70% Factor
	1 800	3 120	3 200	3 300	3 410	3 540	3 700	3 900	4 040	4 150	4 330	4 470	4 620	3 000
2 000	3 480	3 580	3 690	3 830	3 980	4 170	4 410	4 570	4 700	4 910	5 070	5 250	3 333	2 857
2 200	3 720	3 830	3 960	4 110	4 280	4 500	4 750	4 940	5 080	5 310	5 490	5 700	3 667	3 143
2 400	4 100	4 230	4 370	4 540	4 740	4 980	5 260	5 470	5 620	5 880	6 080	6 300	4 000	3 429
2 600	4 450	4 590	4 750	4 940	5 160	5 420	5 740	5 960	6 130	6 410	6 630	6 870	4 333	3 714
2 800	4 760	4 910	5 090	5 290	5 530	5 810	6 150	6 390	6 570	6 880	7 110	7 360	4 667	4 000
3 000	5 070	5 240	5 430	5 650	5 910	6 220	6 590	6 860	7 060	7 390	7 640	7 920	5 000	4 286
3 200	5 450	5 630	5 840	6 090	6 370	6 720	7 130	7 420	7 640	8 010	8 290	8 600	5 333	4 571
3 400	5 740	5 940	6 170	6 430	6 740	7 110	7 550	7 870	8 100	8 500	8 800	9 130	5 667	4 857
3 600	6 050	6 260	6 500	6 780	7 120	7 510	7 990	8 330	8 580	9 000	9 320	9 680	6 000	5 143
3 800	6 340	6 570	6 830	7 130	7 480	7 900	8 410	8 770	9 040	9 490	9 840	10 220	6 333	5 429
4 000	6 550	6 780	7 050	7 370	7 730	8 170	8 700	9 080	9 360	9 830	10 180	10 580	6 667	5 714

**Table 2.2 CRFI Table 2, Landing distance with Discing/ Reverse Thrust [TC, 2010a]**

Reported Canadian Runway Friction Index (CRFI)														
Landing Distance (Feet) Bare and Dry Unfactored	0.60	0.55	0.50	0.45	0.40	0.35	0.30	0.27	0.25	0.22	0.20	0.18	Landing Field Length (Feet) Bare and Dry	Landing Field Length (Feet) Bare and Dry
	Recommended Landing Distances (Discing/Reverse Thrust)												60% Factor	70% Factor
	1 200	2 000	2 040	2 080	2 120	2 170	2 220	2 280	2 340	2 380	2 440	2 490	2 540	2 000
1 400	2 340	2 390	2 440	2 500	2 580	2 660	2 750	2 820	2 870	2 950	3 010	3 080	2 333	2 000
1 600	2 670	2 730	2 800	2 880	2 970	3 070	3 190	3 280	3 360	3 460	3 540	3 630	2 667	2 286
1 800	3 010	3 080	3 160	3 250	3 350	3 480	3 630	3 730	3 810	3 930	4 030	4 130	3 000	2 571
2 000	3 340	3 420	3 520	3 620	3 740	3 880	4 050	4 170	4 260	4 400	4 510	4 630	3 333	2 857
2 200	3 570	3 660	3 760	3 880	4 020	4 170	4 360	4 490	4 590	4 750	4 870	5 000	3 667	3 143
2 400	3 900	4 000	4 110	4 230	4 380	4 550	4 750	4 880	4 980	5 150	5 270	5 410	4 000	3 429
2 600	4 200	4 300	4 420	4 560	4 710	4 890	5 100	5 240	5 350	5 520	5 650	5 790	4 333	3 714
2 800	4 460	4 570	4 700	4 840	5 000	5 190	5 410	5 560	5 670	5 850	5 980	6 130	4 667	4 000
3 000	4 740	4 860	5 000	5 160	5 340	5 550	5 790	5 950	6 070	6 270	6 420	6 580	5 000	4 286
3 200	5 080	5 220	5 370	5 550	5 740	5 970	6 240	6 420	6 560	6 770	6 940	7 110	5 333	4 571
3 400	5 350	5 500	5 660	5 850	6 060	6 310	6 590	6 790	6 930	7 170	7 340	7 530	5 667	4 857
3 600	5 620	5 780	5 960	6 160	6 390	6 650	6 960	7 170	7 320	7 570	7 750	7 950	6 000	5 143
3 800	5 890	6 060	6 250	6 460	6 700	6 980	7 310	7 540	7 700	7 970	8 160	8 380	6 333	5 429
4 000	6 070	6 250	6 440	6 660	6 910	7 210	7 540	7 780	7 950	8 220	8 430	8 650	6 667	5 714

By comparing Table 2.1 to Table 2.2, it is also evident that the landing distance required for the same friction number also increases if the pilot does not use discing or reverse thrust. For example, if the CRFI friction reading is 0.3, using Table 2.1, an aircraft requiring 1220 m (4000 ft.) to land on a bare and dry runway now requires 2652m (8700 ft.) if the pilot does not use reverse thrust or discing to stop. Under the same conditions, according to Table 2.2 the aircraft requires 2300m (7540 ft.) to stop if reverse thrusters and discing are used. The shorter landing distance recommended in Table 2.2 accounts for the effect discing and reverse thrust has on decreasing the distance required for stopping the aircraft.

Another factor that affects the aircraft's ability to safely land is the crosswinds on the runway, as shown in Figure 2.1.

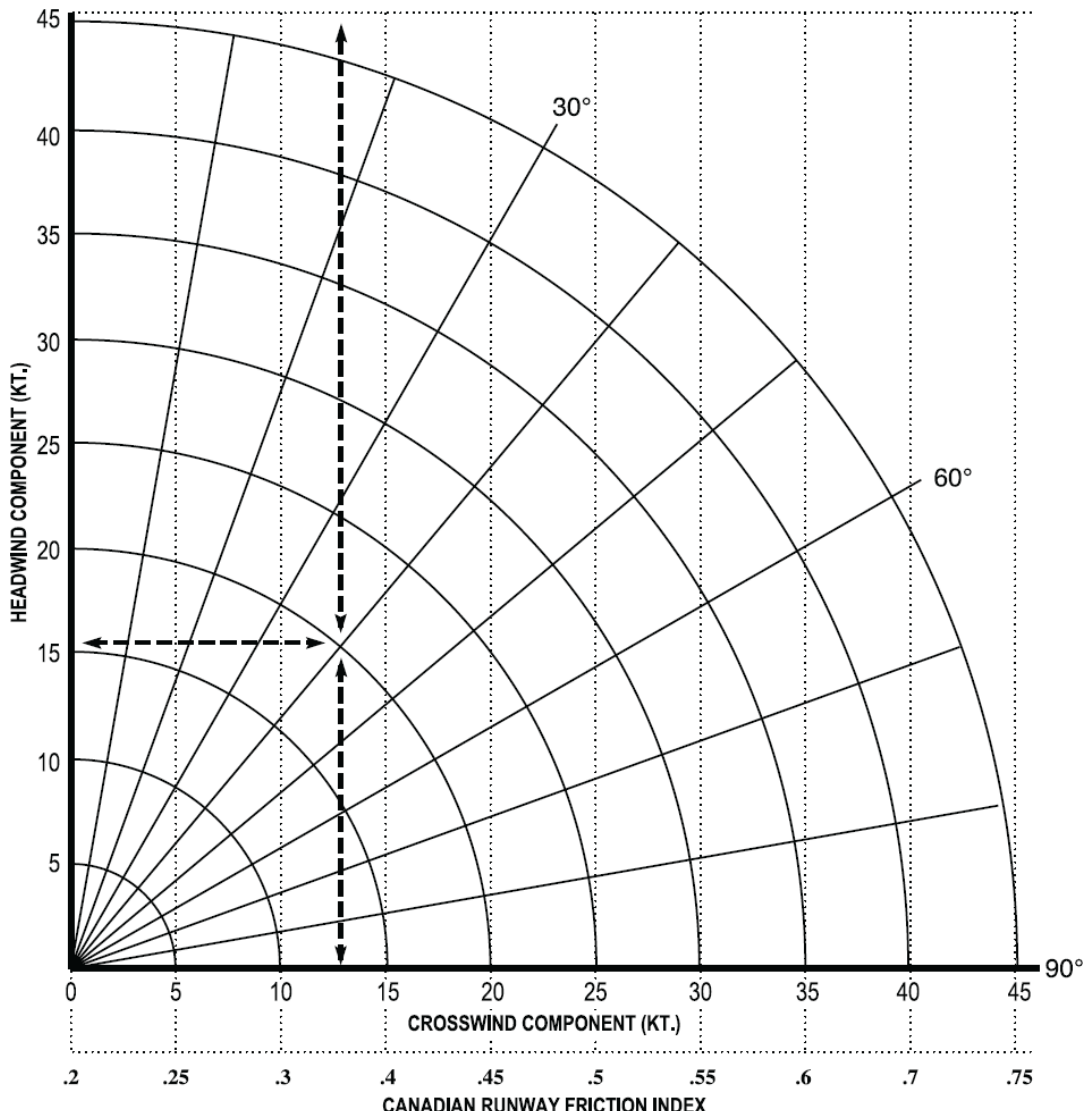
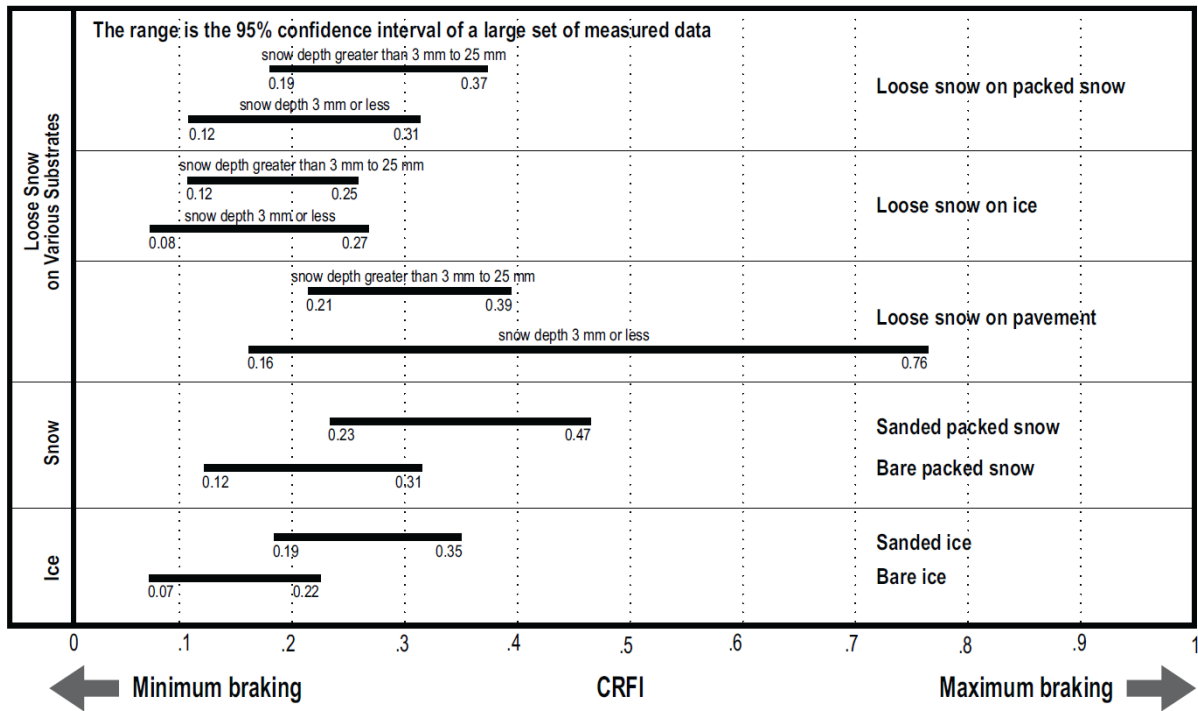

Figure 2.1 - Cross wind limitations for CRFI [TC, 2010a]

Figure 2.1 is used to account for crosswind and headwind and the impact runway friction has on landing safely. In the example illustrated by Figure 2.1, a runway with a crosswind component of 13 KT and a headwind component of 15 KT requires a CRFI of 0.35 (or greater) to safely land. If the CRFI is less than 0.35, the pilot may experience loss of control and yawing of the aircraft [TC, 2012a].

Figure 2.2 shows the range of CRFI's by surface type. The categories shown in this figure are: loose snow on packed snow, loose snow on ice, loose snow on pavement, sanded packed snow, bare packed snow, sanded ice and bare ice.



**Figure 2.2 - CRFI Expected Range of CRFIs by surface type [TC, 2010a]**

Table 2.3 shows maximum and minimum CRFI's by surface type. This table includes the lower CRFI limit and upper CRFI limit for a variety of contaminants, and also includes depth measurements for loose snow on ice, and packed snow on pavement.

When a CRFI measurement is collected, a friction number is reported to the airport operators. The airport operators then send a NOTAM to pilots, advising them of the runway friction at the time the test was collected. Using the lookup table, the pilot can then determine the necessary landing distance based on the runway friction, and make a critical decision regarding their ability to safely land the aircraft.

**Table 2.3 - Minimum and Maximum CRFI Limits by Surface Type [TC, 2010a]**

<b>SURFACE</b>	<b>LOWER CFRI LIMIT</b>	<b>UPPER CFRI LIMIT</b>
Bare Ice	No Limit	0.3
Bare Packed Snow	0.1	0.4
Sanded Ice	0.1	0.4
Sanded Packed Snow	0.1	0.5
Loose Snow on Ice (depth 3 mm or less)	No Limit	0.4
Loose Snow on Ice (depth 3 to 25 mm)	No Limit	0.4
Loose Snow on Packed Snow (depth 3 mm or less)	0.1	0.4
Loose Snow on Packed Snow (depth 3 to 25 mm)	0.1	0.4
Loose Snow on Pavement (depth 3 mm or less)	0.1	Dry Pavement
Loose Snow on Pavement (depth 3 mm to 25 mm)	0.1	Dry Pavement

#### **2.1.4 Criteria for Collecting CRFI Measurements**

In Canada, the Canadian Runway Friction Index (CRFI) is used to translate friction measurements into landing distances. CRFI measurements can be collected when any of the following conditions are present [TC, 2010a]:

- Ice on a runway
- Wet ice on a runway surface (ice covered with water)
- Compacted snow on a runway surface
- Slush on ice
- Loose snow, not exceeding 2.5 cm in depth, on a runway surface
- Urea solution on ice

#### **2.2 Estimating Landing Distances Requirements**

In order to estimate the Landing Distance Required (LDR) for an aircraft to safely stop on a runway, the landing distance available on the runway and the non-aerodynamic deceleration capability of the aircraft must be understood. Additional factors that affect the LDR are airport pressure altitude, wind velocity and direction, the slope of the runway, aircraft configuration and weight, approach speed and planned use of aircraft deceleration devices [ACRP, 2008a]. Human factors such as failure to employ the correct braking procedures in a timely manner, a late touchdown on the runway or a high landing speed during touchdown will also affect the LDR. Following the Southwest Flight 1248 accident at Chicago Midway Airport in 2005, the FAA issued a recommendation that the factors shown in Table 2.4 be applied to dry runway distances calculations for turbo jets [ACRP, 2008a].

**Table 2.4- Factors for Calculating Landing Distance [ACRP, 2008a]**

<b>Runway Condition</b>	<b>Reported Braking Action</b>	<b>Factor</b>	<b>Safety Margin</b>
<b>Dry</b>	No Braking Report	0.8	1.67
<b>Wet Runway, Dry Snow</b>	Good	0.9	3.07
<b>Packed or Compacted Snow</b>	Fair/ Medium	1.2	3.44
<b>Wet Snow, Slush, Standing Water, Ice</b>	Poor	1.6	3.97 - 4.67
<b>Wet Ice</b>	Nil	Landing Prohibited	

The factors shown in Table 2.4 assume maximum braking is applied to stop the aircraft; if reverse thrust is not available then the factors are multiplied by 1.2 [ACRP, 2008a].

### **2.3 Pilot Reports**

Pilot Reports (PIREPS) are reports completed by pilots both inflight and upon landing. PIREPs describe the environmental conditions inflight and any differences between forecasts and what was observed inflight. The information reported in a PIREP is collected and redistributed to provide current, up-to-the-minute information to other pilots flying in the area, ground control towers and weather briefers [TC, 2012c]. PIREPS can also be used to validate forecasts and provide information about areas where topography causes the weather conditions rapidly change or localized phenomena (e.g. hills, large bodies of water) [TC, 2012c].

Figure 2.3 shows a sample PIREP form, and Table 2.5 explains how Pilots complete a PIREP form. PIREPs are to be filed with the local flight information centre (FIC) using an en-route frequency or by calling a toll-free number and filing the report upon landing [TC, 2012c].

PIREPs are to be completed when any of the following conditions occur [FAA, 2012a]:

1. Ceilings at or below 5,000 feet (1524 m).
2. Visibility reported on the surface or aloft is 5 miles (8 047 m) or less.
3. Thunderstorms and related phenomenon.
4. Turbulence of moderate degree or greater.
5. Icing of light degree or greater.
6. Wind shear.
7. Volcanic ash clouds are reported or forecast.

# PIREP FORM

Pilot Weather Report	
3-Letter SA Identifier	→ = Space Symbol
1. UA →	UUA →
	Routine Report      Urgent Report
2. /OV →	Location:
3. /TM →	Time:
4. /FL	Altitude/Flight Level:
5. /TP →	Aircraft Type:
<i>Items 1 through 5 are mandatory for all PIREPs</i>	
6. /SK →	Sky Cover:
7. /WX →	Flight Visibility and Weather:
8. /TA →	Temperature (Celsius):
9. /WV →	Wind:
10. /TB →	Turbulence:
11. /IC →	Icing:
12. /RM →	Remarks:

FAA FORM 7110-2 (1-85) Supersedes Previous Edition

Electronic Version (Adobe)

Figure 2.3 - PIREP Form [FAA, 2012b]



**Table 2.5 - How to Complete a PIREP [FAA, 2012b]**

<b>Label</b>	<b>Explanation</b>	<b>Example</b>
<b>UA</b>	<b>Routine PIREP, UUA - Urgent PIREP</b>	
<b>/OV</b>	<b>Location:</b> Use 3-letter NAVAID idents only. a. Fix: /OV ABC, /OV ABC 090025. b. Fix to fix.	/OV ABC-DEF /OV ABC-DEF 120020 /OV ABC 045020-DEF 120005 /OV ABC-DEF-GHI
<b>/TM</b>	<b>Time:</b> 4 digits in GMT.	/TM 0915
<b>/FL</b>	<b>Altitude/Flight Level:</b> 3 digits for hundreds of feet. If not known, use UNKN.	/FL095 /FL310 /FLUNKN
<b>/TP</b>	<b>Type aircraft:</b> 4 digits maximum, if not known use UNKN.	/TP L329 /TP B727 /TP UNKN
<b>/SK</b>	<b>Cloud layers:</b> Describe as follows: a. Height of cloud base in hundreds of feet. If unknown, use UNKN. b. Cloud cover symbol. c. Height of cloud tops in hundreds of feet. d. Use solidus (/) to separate layers. e. Use a space to separate each sub element.	/SK 038 BKN /SK 038 OVC 045 /SK 055 SCT 073/085 BKN 105 /SK UNKN OVC
<b>/WX</b>	<b>Weather:</b> Flight visibility reported first. Use standard weather symbols, intensity is not reported.	/WX FV02 R H /WX FV01 TRW
<b>/TA</b>	<b>Air temperature in Celsius:</b> If below zero, prefix with a hyphen.	/TA 15 /TA -06
<b>/WV</b>	<b>Wind:</b> Direction and speed in six digits.	/WV 270045 /WV 280110
<b>/TB</b>	<b>Turbulence:</b> Use standard contractions for intensity and type (use CAT or CHOP when appropriate). Include altitude only if different from /FL.	/TB EXTRM /TB LGT-MOD BLO-090
<b>/IC</b>	<b>Icing:</b> Describe using standard intensity and type contractions. Include altitude only if different than /FL.	/IC LGT-MDT RIME /IC SVR CLR 028-045
<b>/RM</b>	<b>Remarks:</b> Use free form to clarify the report. Most hazardous element first (Refer to FAAH 7110.10 for expanded explanation of TEI coding).	/RM LLWS -15KT SFC-003 DURGC RNWY 22 JFK

PIREPs should also be completed, regardless of the weather conditions when [FAA, 2012a]:

1. A National Weather Service (NWS) or Air Traffic Control (ATC) facility indicates a need because of a specific weather or flight assistance situation.
  2. Necessary to determine flying conditions pertinent to natural hazards (mountain passes, ridges, peaks) between the weather reporting stations.
  3. The station is designated as responsible for PIREPs in an offshore coastal area.
- c. Flight watch specialists must solicit sufficient PIREPs to remain aware of flight conditions.
  - d. To solicit PIREPs within a specific area, broadcast a request on NAVAIDs, transcribed broadcast facilities, or a selected communications frequency.

## **2.4 Takeoff and Landing Performance Assessment**

The Takeoff and Landing Performance Assessment (TALPA) Aviation Rule Making Committee (ARC) was created by the FAA following the Southwest incident at Chicago Midway Airport. The FAA investigation of the Southwest flight revealed that existing industry procedures did not provide enough guidance and regulation for aircraft operations on contaminated runways [FAA, 2009b].

The goal of TALPA ARC was to identify shortcomings in standard practice and to create recommendations for improving the state of practice. The TALPA ARC reviewed information that was being collected by airports, and identified opportunities for removing subjectivity and improving the quality of data collected. In addition, the TALPA ARC reviewed how information is distributed to pilots, and provided guidelines for improving communication and information distribution.

A significant conclusion from the TALPA ARC study was that pilots need to be provided with real time information when assessing runway conditions for making takeoff and landing decisions. Additionally, the information provided to pilots must directly relate to the expected performance of their aircraft [FAA, 2009b].

In addition to PIREPs, another form of providing pilots with information is through Notice to Airmen (NOTAM). NOTAMs are reports written by the airport operators that advise pilots of the ground conditions at the airport. NOTAMs are written whenever the runway surface is not bare and dry. In the investigation, a series of shortcomings were identified in how NOTAMs are being delivered and in how vital information is currently being relayed to pilots [FAA, 2009b]. For example, the TALPA ARC observed that NOTAMs should be available in real time to pilots, and in a digital format. One of the outcomes of the TALPA ARC working group was providing recommendations for reformatting NOTAMs, to enhance the communication with pilots [FAA, 2009b].

The series of recommendations for improving NOTAMs included utilizing a Paved Runway Condition Assessment Table (PRCAT) as a standardized means of evaluating and reporting runway conditions. The goal of the PRCAT was to remove subjective observations and use standardized measurements collected by airport operators to provide pilots with real time information regarding runway conditions. The PRCAT information is supplied to pilots in a format that is consistent with airplane braking performance data provided by aircraft manufacturers for specific contaminant types and depth. Table 2.6 shows the paved runway condition assessment table and the information that would be supplied to pilots in a PIREP.

**Table 2.6 - Paved Runway Condition Assessment Table [Marchi, 2012]**

Airport Estimated Runway Condition Assessment				Pilot Reports (PIREPs) Provided To ATC And Flight Dispatch
Runway Condition Assessment – Reported		Downgrade Assessment Criteria		
Code	Runway Description	Mu ( $\mu$ )	Deceleration And Directional Control Observation	PIREP
6	• Dry	-	-	Dry
5	• Wet (Smooth, Grooved or PFC) • Frost <i>1/8" or less of:</i> • Water • Slush • Dry Snow • Wet Snow	40 $\mu$ or higher	Braking deceleration is normal for the wheel braking effort applied. Directional control is normal.	Good
4	<i>At or below -13°C:</i> • Compacted Snow	39-36 $\mu$	Brake deceleration and controllability is between Good and Medium.	Good to Medium
3	• Wet (Slippery) <i>At or below -3°C:</i> • Dry or Wet Snow greater than 1/8" <i>Above -13°C and at or below -3°C:</i> • Compacted Snow	35-30 $\mu$	Braking deceleration is noticeably reduced for the wheel braking effort applied. Directional control may be slightly reduced.	Medium
2	<i>Greater than 1/8" of:</i> • Water • Slush <i>Above -3°C:</i> • Dry or Wet Snow greater than 1/8" • Compacted Snow	29-26 $\mu$	Brake deceleration and controllability is between Medium and Poor. Potential for hydroplaning exists.	Medium to Poor
1	<i>At or below -3°C:</i> • Ice	25-21 $\mu$	Braking deceleration is significantly reduced for the wheel braking effort applied. Directional control may be significantly reduced.	Poor
0	• Wet Ice • Water on top of Compacted Snow • Dry or Wet Snow over Ice <i>Above -3°C:</i> • Ice	20 $\mu$ or lower	Braking deceleration is minimal to non-existent for the wheel braking effort applied. Directional control may be uncertain.	Nil

The PRCAT shows seven different runway conditions that could be reported to pilots in the PIREP. Typically, pilots will report landing conditions for the runway using a number (from 0 to 6) for each third of the runway. In the gradation, 0 represents the worst braking conditions, and 6 represents the most ideal conditions.

For example, a runway reported as 3/3/2, is wet (slippery) with medium braking action for the first two-thirds of the runway (from the landing approach) and medium to poor braking action for the last-third of the runway. When the runway was assessed, it met the conditions for a 3/3/3 rating. However, airport operators can downgrade the rating for any third of the runway based on PIREPs and operator judgment. In order to provide conservative reports, runway assessments may only ever be downgraded (e.g. from a 3 to 2), never upgraded based on subjective observation alone. Airports must collect runway condition data frequently and report changes in runway conditions during contaminated conditions.

In order for this new standardized PRCAT to be used successfully, users (airport operators, pilots, air traffic control) must be extensively trained and comfortable in completing and interpreting a PRCAT in a consistent and uniform manner. Terminology, reporting style and measurement techniques need to be standardized between airports, to eliminate the potential for misinterpreting report data.

Within the recommendation to use a standardized PRCAT, the TALPA ARC working group noted the need for further study and testing of the PRCAT at a variety of airports before widespread adoption by the industry.

## **2.5 Aircraft Landing**

During aircraft landing, the aircraft speed is reduced to a speed just above engine stall (plus a safety factor), as the aircraft steadily descends towards the runway. Engine stall is defined as the point when air is unable to pass through the various engine components. During good conditions (i.e. clear weather and a bare and dry runway), a gentle landing can be achieved by reducing landing speed immediately prior to touchdown.

There are five phases to landing an aircraft: approach, flare, touchdown, ground roll and stopping [ACRP, 2008a]. The approach phase is when the aircraft lines up with the runway and begins descent towards the airport. Typically, pilots guide the aircraft to intercept the descent path directed towards the runway, and then descend on a path inclined 3° to the horizontal; this path is commonly referred to as the glideslope [ACRP, 2008a].

Depending on the navigational guides used by the pilot, an airport approach can be categorized as a visual approach or an instrument approach. Visual approaches are only allowed if the visibility is greater than 3 nautical miles and if the pilot has the airport or preceding aircraft in sight [ACRP, 2008a]. In a visual approach, the pilot must follow Instrument Flight Rules (IFR), and the cloud ceiling must be 500 feet above the minimum IFR altitude for that particular airport. In inclement weather situations, instrument guided approaches are used as there tends to be low visibility in the area surrounding the airport.

Instrument guided approaches are further categorized as precision or non-precision approach. Non-precision approaches involve instrumentation that provides the pilot with guidance in the horizontal plane only and may involve the use of a Precision Approach Path Indicator or a Visual Approach Slope Indicator System. Approaches on the glideslope are considered precision approaches. Non-precision approaches may be facilitated using Localizers (Instrument Landing Systems without glideslope), Very High Frequency Omnidirectional Range (VOR), Non-Directional Beacon (NDB), Automatic Direction Finder (ADF) and Global Positioning System (GPS). VOR is often used in conjunction with distance measuring equipment that informs the pilot of the distance to the runway.

Precision approaches provide the pilot with directional information in the vertical (up or down) direction for the glideslope and in the horizontal (left or right) direction, called the localizer. An Instrument Landing System (ILS) can be used to guide a pilot towards the airport; the ILS sends an electronic beam from the ground to instrumentation in the cockpit to provide pilot with information required to stay on track for a precision approach. The ILS often consists of an outer marker, middle marker and inner marker on the flight path approaching the airport. The markers can be used to determine the distance to the critical point for making a missed approach if the runway conditions are not suitable for landing. Based on the signal from the ILS, the pilot can ensure the aircraft is lined up with the runway and approaching the runway on the 3° glideslope. In addition to ILS, Pilots have a series of navigational aids available to them including Microwave Landing System (MLS), Precision Approach Radar (PAR), GPS that includes vertical navigation and Joint Precision Approach and Landing system. Figure 2.4 is an illustration of the glideslope as an aircraft approaches the runway.

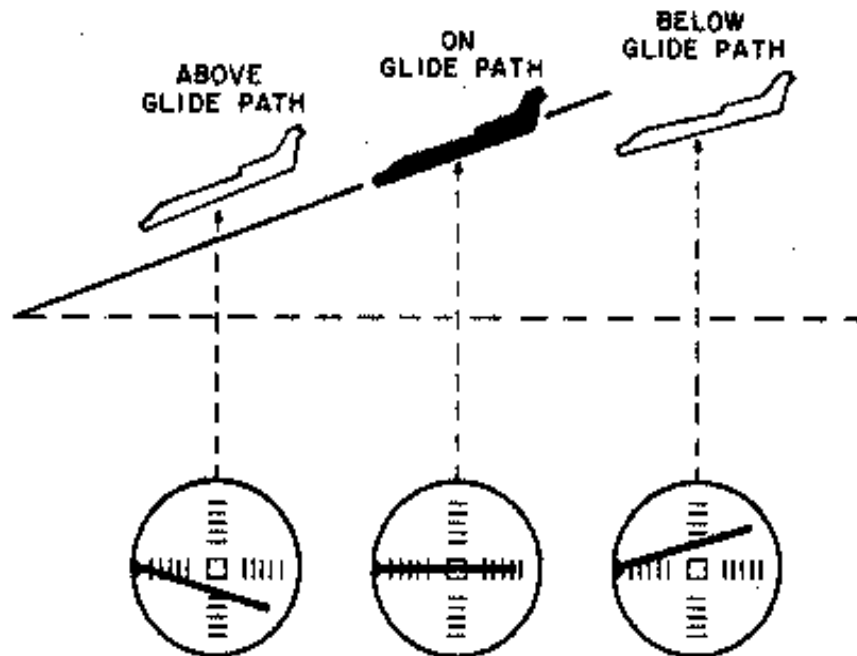

**Figure 2.4 - Illustration of glideslope and pilot instrumentation [Thales, 2007]**

It is the responsibility of pilots to determine the optimal speed, power and flap configuration during the approach to the airport [ACRP, 2008a]. Pilots must also adjust heading to account for drift caused by the crosswind component of wind velocity. The aircraft weight and environmental conditions, including wind speed and direction are factored into the power changes necessary for the pilot to maintain a steady approach to the runway.

The reference approach speed,  $v_{ref}$ , is the speed in calm air as the aircraft crosses the runway threshold at a desired height, normally 15.24 m (50 ft.) [ACRP, 2008a]. The reference speed is used by pilots to calculate landing distances and determine the landing configuration. Normally, the target arrival speed is 30% more than the engine stall speed,  $v_{so}$ . Aircraft speed is an important factor in the landing; if the aircraft is traveling too slow it may undershoot the runway, especially if there is wind variation and if the aircraft is travelling too fast the braking distance will be increased which may result in an overrun. An aircraft travelling too fast during the approach also decreases the safety margin assumed in the braking distance calculation; which is especially problematic if there is a contaminant on the runway.

## **2.6 Case Study Aircraft: Boeing 737**

The Boeing 737 aircraft is one of the most commonly used aircrafts in commercial aviation, and it was the type of aircraft involved in the Southwest accident at Chicago Midway Airport in 2005. Although the landing gear configuration varies between aircrafts, the concepts describing the braking features of the Boeing 737 within this section are consistent with the braking systems used by most commercial aircrafts.

The Boeing 737 is equipped with four wheels in the landing gear, each with a multi-disc hydraulically powered brake. The nose wheels are not equipped with brakes. The non-aerodynamic components of the aircraft brake system include the primary brake system, a secondary brake system, an autobrake system, an accumulator, antiskid protection and parking brakes. Sensors detect the hydraulic pressure in the primary braking system, if the hydraulic pressure is not high enough in the primary braking system the secondary braking system will automatically engage. If both the primary and secondary braking systems fail, then the hydraulic energy stored in the brake accumulator can be combined with the parking brakes to stop the aircraft [FAA, 2011b].

When the autobrake system is armed, it automatically engages the brakes after touchdown or a rejected takeoff. When the brakes are applied, the two throttles on the Boeing 737 retard to idle and the main wheels spin up. The autobrake pressure is reduced as other aerodynamic devices such as reverse thrusters and spoilers are utilized to decelerate the aircraft. A pilot can also override the autobraking system by engaging the manual brakes. In addition, the brake pedals in the cockpit provide separate control over the left and right brakes. On the Boeing 737, the autobrake system has four settings of providing the aircraft with deceleration: Off, 1, 2, 3 and Maximum, with an additional setting for rejected takeoff (RTO) [FAA, 2011b]. The autobrake settings are arranged in terms of increasing hydraulic pressure applied to the brakes. The maximum setting would typically be used on a wet runway. In general, pilots arm the autobrake system before landing; however, the autobrake system can still be used if the deceleration of the landed aircraft exceeds 60 knots [FAA, 2011b]. In the case of rejected take off, the autobrake system can be engaged at 90 knots [FAA, 2011b]. The

autobrake system is designed to bring the aircraft to a complete stop unless the pilot overrides the system [FAA, 2011b].

The Boeing 737 also uses speed brakes and thrust reversers as an aerodynamic means of slowing down the aircraft and spoiling lift, both in flight and during the landing procedure. On the Boeing 737, the speed brakes consist of 12 hydraulically powered panels on the upper surface of the aircraft wings. During landing, armed speed brakes will deploy when the wheels of the aircraft speed up to 60 knots [FAA, 2011b]. Thrust reversers redirect engine fan discharge air forward, which aids in slowing down a landing aircraft. Aerodynamic braking systems are not affected by contaminants on the runway. However, delay in deploying aerodynamic brakes will contribute to the risk of runway overruns in contaminated situations [ACRP, 2008a].

## **2.7 Airport Pavement Design**

In general, airport pavement can be designed using an experienced based approach, by using empirical data as the basis of design, by using a mechanistic-empirical approach or by using a purely mechanistic design [TAC, 2012]. Historically, airport pavement was designed by empirically modifying highway standards to suit the airport applications. One of the limitations of using this empirical approach is that it is difficult to estimate pavement performance for conditions not represented by the empirical pavement data.

Over time, it became apparent that the practice of empirically modifying highway pavement designs is inadequate, as highway standards cannot be extrapolated to accurately account for the design loading conditions of new large aircrafts [Whiteley, 2006]. As a result, the Federal Aviation Authority (FAA), Transport Canada and other international organizations have begun investigating mechanistic-empirical design methods and have now published design guidelines intended to accommodate new large aircrafts.

The International Civil Aviation Organization (ICAO) produced guidelines, standards, best practices and recommended procedures for all technical aspects of aviation. Although the ICAO does not produce a specific pavement design procedure, it publishes the design standards of several countries, including Canada and the United States [Whiteley, 2006]. Design standards are available for flexible asphalt pavements, rigid concrete pavements and composite asphalt-concrete pavements.

Structural performance tends to be the primary focus of pavement design; however, there is considerable attention dedicated towards ensuring runways have high friction surfaces. Providing adequate runway friction is imperative for safe runway operations. In particular, runway friction is important for accelerating wheel spin at touchdown so that wheels reach their full rotational speed, and for helping landing aircrafts decelerate and rejected takeoffs safely stop [Fwa, 1997].

### **2.7.1 Pavement Friction, Microtexture and Macrotecture**

Runway friction can be achieved through correct pavement mix design and placement during construction. High pavement friction can be achieved by properly engineering the design aggregate macrotecture and microtexture. Pavement macrotecture is the distribution and profile of the surface aggregate relative to the overall pavement surface profile. Pavement microtexture is the surface

profile of individual pieces of aggregate and of the pavement binder. Figure 2.5 is an illustration of pavement macrotexture and microtexture.

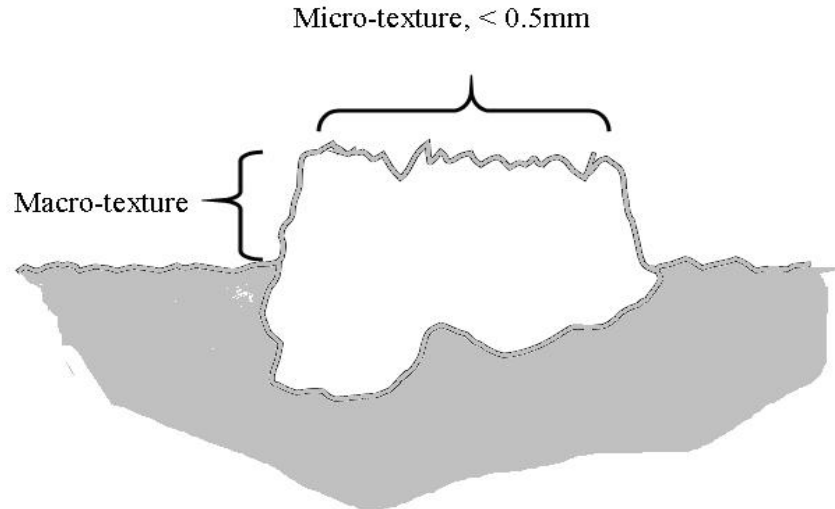

**Figure 2.5 - Illustration of pavement microtexture and macrotexture. [MTO, 2010]**

The microtexture of the pavement describes the surface characteristics of the aggregates that the pavement is comprised of and is usually measured in the 0 mm to 0.3 mm range. Microtexture is generally not visibly discernible. However, the rough microtexture of a pavement sample can be felt when the aggregate surface is examined. The friction provided by the microtexture is important for aircrafts traveling at low speeds. The pavement microtexture is a result of the aggregate selection in asphalt pavements; choosing coarsely graded aggregates in the mix design will lead to a better microtexture. Using aggregate with high silica content also helps prevent polishing of the aggregate and maintains the coarse microtexture [Speidel, 2002]. To create a good microtexture in Portland Cement Concrete (PCC) surfaces, freshly placed concrete can be brushed, broomed or finished with a burlap drag. Wire combs and steel wires can also be used immediately following PCC placement to create a rough microtexture; however, this method may create a microtexture that is too rough. Around 1990, a Navy airport in Maryland specified using wire tining to form deep texture in the concrete runway; the resulting runway friction was so high that aircraft tires were blowing upon landing [Speidel, 2002]. As a result, this airport had to mill the runway pavement to create a less rough runway surface.

The macrotexture of the runway pavement describes the surface characteristics of the pavement as a whole. Unlike microtexture, the macrotexture is visibly discernible and is usually in the 0.3 mm to 3 mm range. The friction provided by macrotexture is important for aircrafts travelling at high speeds, it is therefore critical for aircrafts as they touchdown. The macrotexture in the runway pavement creates channels for water to drain off the runway surface, which helps reduce the risk of aircrafts hydroplaning when they land. Achieving good macrotexture can be accomplished by sawing or creating groves in new or existing runway pavements [Speidel, 2002].



Increasing the roughness of the pavement microtexture contributes to runway friction by increasing skid resistance of the pavement in dry conditions. Contaminants, such as water and wet snow, lubricate the surface of aggregates, decreasing the overall pavement friction. In contaminated conditions, a rough runway pavement macrotexture works with the pressure from the aircraft tire to improve friction by providing paths between the aggregate that help drain contaminants away from the pavement surface [TAC, 1997].

Diamond grinding the pavement can also be performed to introduce grooves into the pavement surface. The grooves in the pavement increase the overall friction of the pavement, and should be oriented to provide drainage channels for surface contaminants. The grooves need to be cleaned regularly, to remove dust and rubber build up from landing aircraft tires.

## **2.8 Pavement Management**

Equally important to the pavement design is the maintenance and management of the runway pavement. Weathering, polishing of aggregate, pavement age, volume of traffic, and rubber buildup from aircraft tires reduces runway pavement friction. For this reason, it is important that airport operators regularly monitor and measure the integrity of the pavement so that routine maintenance can be performed.

It is important that regular pavement evaluations are conducted to identify any cracks, holes, loose aggregate, joint failures or deficiencies in the runway pavement. Airport Operators can hire an external consultant or employ an internal pavement engineer to develop and maintain an airport pavement management system that includes regular inspections, performance modeling and evaluation, and a schedule for routine maintenance and rehabilitation treatments [Tighe, 2008]. As part of the ongoing pavement management system, nondestructive tests should be performed routinely to verify the strength of the pavement. In dry conditions, friction tests should be performed daily and should be performed continually during contaminated conditions. Approved chemical solvents can be used to remove rubber build up and environmental contaminants. Snow and ice are most commonly removed mechanically using snowplows and brooms.

## **2.9 Airport Operations**

The airport should also produce a set of guidelines and procedures for winter and wet operations. The winter operations guide should identify personnel or organizations responsible for routine and emergency snow removal. The guide should also include relevant standards and regulations for measuring, monitoring and removing runway contaminants. Training airport maintenance crews to use runway cleaning and testing equipment, and to properly report runway conditions is also an important component of the airport operation [Wells, 2004]. Lastly, the airport should regularly collect meteorological data and use the forecasts to anticipate the length, duration and type of inclement weather. Frequent environmental reports will help the airport maintenance crews prepare for poor weather conditions.

### **2.9.1 Snow and Ice Operations Plan**

Many airports in the northern and mountainous regions of Canada and the United States provide Snow and Ice Control Management plans outlining procedures for removing winter contaminants

from the runway and other airport pavements including taxiways and aprons. Typically, these plans include a brief statement of purpose, a contact list identifying internal personnel and external organizations responsible for winter maintenance, the relevant standards and procedures that must be followed and a training module for users [Wells, 2004]. Some airports will use an internal team of employees and equipment for maintaining runways and airport pavement during winter months; other airports will use municipal maintenance crews or hire external organizations.

The snow and ice plan will include a priority list for clearing runways, taxiways, aprons and additional airport pavement. It will provide a detailed list of suitable chemical agents that can be used for de-icing the airside pavement, and the material safety data sheets for these products. The snow and ice plan should also include a layout map of the airport illustrating suitable routes for snow removal equipment and dumping areas for collected snow. The dumping area must be sufficiently far from the runway so as not to be an obstruction for aircrafts, and it must be shaped to conform to aerodrome standards for clear space surrounding a runway. The description of the collected snow stockpile area will often include the suitable slope and maximum height for building the snow pile in accordance with aerodrome standards.

## **2.10 Friction Testing**

As a part of pavement management and regular operations, airport operators use friction testers to determine the runway's friction characteristics. Factors such as frequent use, pavement age, structural degradation, polishing of the surface by aircraft tires and contaminant buildup from rubber tires contribute to the decrease in friction values of the runway pavement surface over time. Airport specific factors such as the volume of traffic using the runway and the characteristics of landing aircrafts (weight and wheel configuration) also affect the pavement friction; an airport with a high volume of mostly heavy aircrafts landing will experience a more rapid deterioration in runway friction than an airport with low volume air traffic and mostly small planes landing. The 100 m area with the lowest friction tends to be the touchdown zone on the runway [TC, 2012b].

In Canada, airports are a private not for profit organization operated by Local Airport Authorities. Transport Canada provides guidelines for collecting runway friction tests, however, the frequency of runway friction tests is at the discretion of the airport operator during good weather conditions, and as needed up to a continual basis during bad weather events [TC, 2012b]. During the summer, the primary concern related to friction pertains to rubber buildup from aircraft tires and wet contaminants causing reduced friction. During winter, contaminants such as snow, slush and ice are the primary concerns.

Airport runway friction testers can be classified into two primary categories, Ground Test Vehicles and Ground Test Trailers. A ground test vehicle is a vehicle that includes the friction testing mechanism as a part of the vehicle chassis. Examples of ground test vehicles are Instrumented Tire Test Vehicle, Diagonal Braked Vehicle, Electronic Recording Decelerometer Vehicle, Runway Friction Tester, Airport Surface Friction Tester and Surface Friction Tester [Yagger, 2008]. A ground test trailer is a friction testing device that is towed down the runway by a separate vehicle.

## 2.11 Chapter Summary

Current state of practice at Canadian Airports is to measure CRFI friction using a CFME decelerometer. Information about inflight conditions and landing the aircraft is also collected and distributed using PIREPs. Air traffic controllers convey CRFI numbers and relevant environmental conditions using NOTAMs. Pilots use the CRFI number in combination with aircraft specific factors to estimate the landing distance required to safely stop the plane.

Following the Southwest accident at Chicago Midway airport in 2005, the TALPA ARC was created and tasked with reviewing the state of practice in collecting and distributing runway information in the United States. The outcome of the review was a series of recommendations in how subjectivity can be removed in reporting runway conditions. In addition, the TALPA ARC recommended real time digital communication with pilots to provide the most accurate and current information. This thesis evaluates the method of collecting and reporting runway surface condition information to pilots currently used by Canadian aerodromes. One of the goals of this thesis is to provide recommendations for improving the Canadian state of practice for measuring and reporting runway conditions to pilots.

Pavement friction is a key characteristic of runway pavement that contributes to safe landings and the distance required to stop the aircraft. Pavement microtexture and macrotexture are created by correct aggregate selection and surface finishing technique. Macrotexture and microtexture must be maintained and monitored; this information is often stored in an airport's pavement management system. This thesis discusses pavement design, and how runway pavements specifically can be designed to promote friction characteristics that contribute to safe aircraft landings. In addition, this thesis discusses how airport pavement management systems can be effectively be used as a tool to monitor pavement. Furthermore, airport pavement management systems are presented in this thesis as a tool for scheduling maintenance and rehabilitation treatments to optimize pavement performance within an airport's budgetary constraints.

It is common for airports in northern climates to create a snow and ice control management plan as a part of their pavement management system. This plan provides guidance for frequency of runway testing, winter contaminant removal and disposal. In addition to winter contaminant, age, frequency of use and rubber build up affect the friction characteristics of the runway. This thesis discusses rubber buildup; the effect rubber has on safe landings, and methods for removing rubber buildup. This thesis includes four commonly used runway rubber removal methods. In addition, this thesis includes a decision making tool that can be incorporated into the airport's pavement management system to select the optimal technique for rubber removal.

Lastly, this chapter introduced the braking system of the Boeing 737, a commonly used commercial aircraft. This thesis discusses how aircraft antiskid braking systems work to increase braking distances when deformable contaminants are present on a runway. The Braking Availability Tester (BAT) is introduced as a device that accounts for aircraft antiskid braking systems, and can be used to measure the effect deformable contaminants have on runway braking availability. The proposed framework for testing and validating the BAT is discussed in this thesis. This thesis also discusses how the BAT can be used to collect information about pavement condition and contaminant buildup that can be incorporated into an airport's pavement management system.

### **2.11.1 Chapter Key Points**

The literature review revealed the aviation industry requires:

- Better communication with pilots to ensure pilots receive real time information that is reliable, accurate and objective.
- A tool that quantifies the effect antiskid braking has on braking distances when a contaminant is present.
- Frequent friction testing depending on aircraft traffic.
- Effective means for monitoring pavement performance and data collection.

## **Chapter 3**

### **Airport Pavement Design and Management**

#### **3.1 Goals in Runway Pavement Design**

Runway pavement should be designed to provide good bearing strength, good riding quality and good surface friction characteristics [ICAO, 2012]. Providing a good bearing strength is the structural design goal for pavement, providing a good riding quality is the geometric design goal, and providing good surface friction characteristics is the goal for achieving good texture and surface drainage. Additionally, goals in good pavement design are to ensure the longevity of the pavement and design a surface that is easy to maintain; as this will lead to economic savings and optimized use of the runway [ICAO, 2012].

Runway pavement is generally classified as rigid, flexible, or composite. Rigid pavement structures are made from Portland Cement Concrete (PCC) and flexible pavement sections are generally made using asphalt. Composite pavement structures are created when an overlay pavement is added to an existing runway pavement structure. In a composite pavement structure, the original runway surface may be asphalt with a concrete overlay (flexible with rigid overlay) or concrete with an asphalt overlay (rigid with a flexible overlay).

This chapter describes the current standard set by the FAA for Airfield design. The FAA standards are implemented in their program called FAA Rigid and Flexible Iterative Elastic Layer Design (FAARFIELD). The FAARFIELD program is based on failure models of tests airport pavement conducted from the 1940s [FAA, 2009a]. This chapter also focuses on runway pavement design, although the FAA standards provide guidance for designing taxiways, aprons and other airport pavements.





When designing an airport pavement section, there are several parameters that are difficult to quantify but must be considered. Although this topic is well researched, the FAA does not publish direct thickness requirements for runways because the interacting variables that are used as inputs in design are often difficult to quantify [FAA, 2009a]. Instead, the FAA recommends designing based on theoretical analysis of conditions such as soil performance, experimental pavement performance and anticipated performance of pavement given expected loading and repetitive use [FAA, 2009a]. The design life for pavement (without major maintenance treatment) is 20 years, assuming traffic conditions do not change from the design forecast. Weathering and the effects of repeated use may require the pavement to be rehabilitated during the 20 year design life.



The basic parameters that are considered in selecting the pavement thickness are: traffic, characteristics and volume of aircrafts, distribution of traffic, and strength and engineering properties of the native and engineered subgrade materials.

#### **3.2 Incorporating Aircraft Factors in Design**

The aircraft size, weight and tire configuration affect the load distribution on the runway pavement. Table 3.1 shows typical gear configurations for commonly used aircrafts.

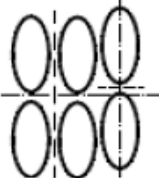
**Table 3.1- Airplane Gear Configuration and Naming Convention [FAA, 2009a]**

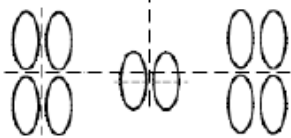
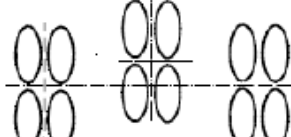
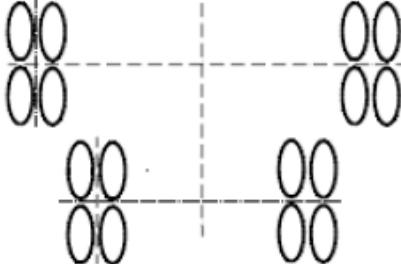
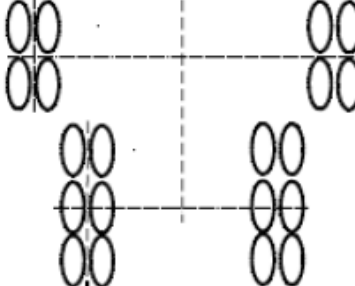
Gear Designation	Gear Designation	Airplane Example
S	 Single	Sngl Whl-45
D	 Dual	B737-100
2S	 2 Singles in Tandem	C-130
2D	 2 Duals in Tandem	B767-200
3D	 3 Duals in Tandem	B777-200
2T	 Two Triple Wheels in Tandem	C-17A

Gear Designation	Gear Designation	Airplane Example
2D/D1	 <p data-bbox="488 474 992 531">Two Dual Wheels in Tandem Main Gear/Dual Wheel Body Gear</p>	DC10-30/40
2D/2D1	 <p data-bbox="488 699 992 762">2D/2D1 Two Dual Wheels in Tandem Main Gear/Two Dual Wheels in Tandem Body Gear</p>	A340-600 std
2D/2D2	 <p data-bbox="488 1056 992 1108">Two Dual Wheels in Tandem Main Gear/Two Dual Wheels in Tandem Body Gear</p>	B747-400
2D/3D2	 <p data-bbox="488 1423 992 1476">Two Dual Wheels in Tandem Main Gear/Three Dual Wheels in Tandem Body Gear</p>	A380-800
5D	 <p data-bbox="516 1822 963 1843">Five Dual Wheels in Tandem Main Gear</p>	An-124

The illustrations shown in Table 3.1 depict the most commonly used wheel configurations of aircraft gears. As Table 3.1 shows, there is a wide variety of tire configurations used by common aircrafts. The large variation in wheel arrangement is one of the factors that makes runway pavement so dynamic; unlike highway pavement design where the vehicles tend to follow the same tire path, a runway will see a variety of aircrafts landing with a wide range in wheel configuration. The implication is that unlike highway pavement, runways do not have a clearly defined wheel path configuration.

The landing gear configuration affects the distresses in the pavement and consequently, the pavement's response to the aircraft loading [FAA, 2009a]. Figure 3.1 shows the load distribution through a pavement cross-section, and the effective tire width of two tires, without overlap on the pavement subgrade.

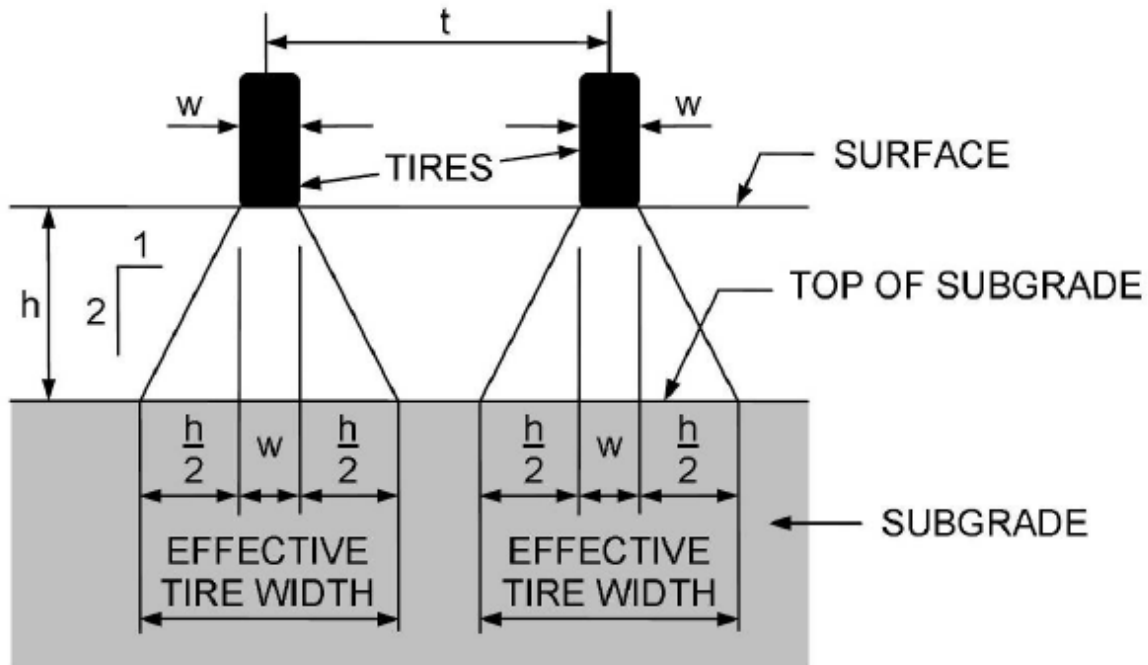

**Figure 3.1 – Two Effective Tire widths, no overlap [FAA, 2009a]**

When the aircraft tires are sufficiently far apart, there is no overlap of the effective tire width on the pavement subgrade and pavement structure. Figure 3.2 shows the load distribution through a pavement cross-section, and the effective tire width of two tires, with overlap on the pavement subgrade.



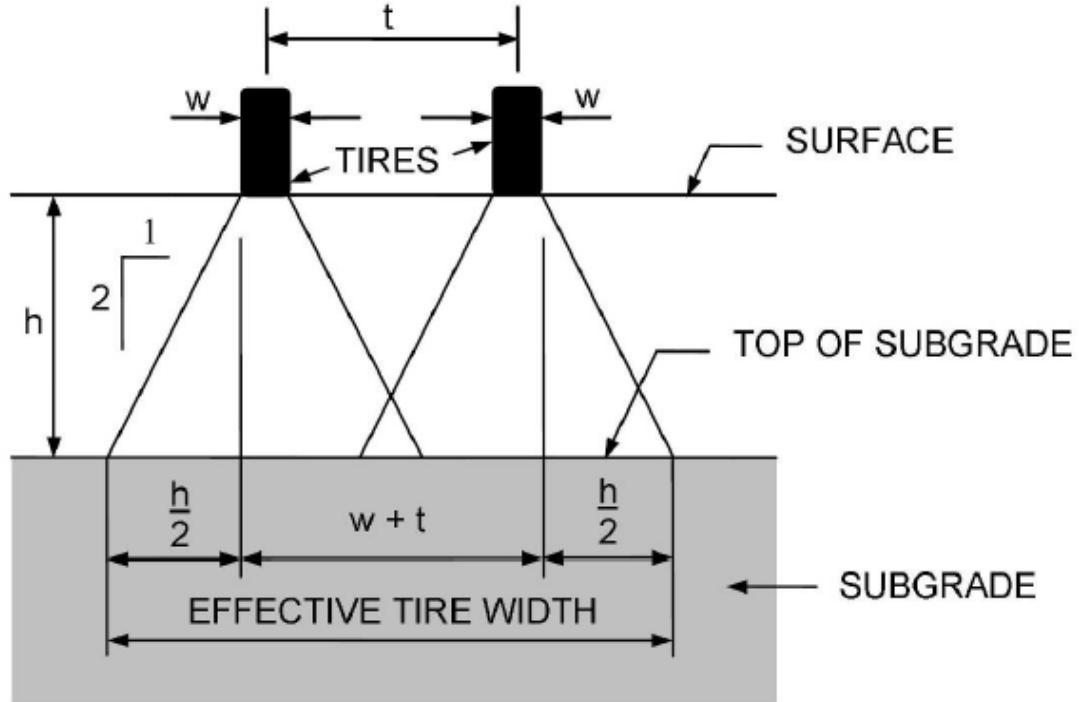

**Figure 3.2 – One Effective Tire Width, With Overlap [FAA, 2009a]**

The aircraft load is another important input used in design calculations. To be conservative, the maximum anticipated take of weight (which aircraft manufactures supply) should be used for the design weight of aircrafts. FAARFIELD assumes that the gross weight of the aircraft is distributed so that 95% of the gross weight is carried by the main landing gears and 5% of the gross aircraft weight is carried by the nose gear [FAA, 2009a].

Aircraft tire pressure is a function of the aircraft gross weight, tire configuration and tire size. The aircraft tire pressure affects the strains in the pavement; in asphalt pavement, the strain is greater in the surface asphalt layer than in the subgrade [FAA, 2009a].

One factor that is difficult to account for in long term pavement design is the introduction of new aircrafts. New Large Aircrafts is a category of aircrafts that are heavier and larger than previous generations of aircrafts. The aviation industry is currently working to respond and better understand the impact New Large Aircrafts (e.g. the Airbus A-380) have on pavement.

### 3.2.1 Impact of Traffic

It is important that pavement engineers have access to current and projected traffic volume when designing a new pavement section. Engineers can use forecasts from the Airport Master Plan, the National Plan of Integrated Airport Systems, local aviation and terminal activity statistics, and projections from major carriers to project future flight frequency, aircraft types and aircraft takeoff weight [FAA, 2009a]. The pavement designer should consider a reasonable mix of heavy aircrafts, and a wide selection of aircraft types (with different landing gear configurations) landing at the airport.

Older design models required converting the loading from the aircraft traffic mixture into an equivalent loading for a design aircraft. Typically, the design aircraft was selected as the airport's most damaging aircraft, based on gross weight, and number of anticipated departures [FAA, 2009a]. Newer pavement design programs such as FAARFIELD calculate pavement thickness by looking at the cumulative damage caused by all of the aircrafts that use the airport pavement. The FAARFIELD program calculates a Cumulative Damage Factor (CDF), a ratio that quantifies the amount structural fatigue life the pavement has used [FAA, 2009a].

The following equations are used by the FAARFIELD program to calculate CDF [FAA, 2009a]:

---

(Eq. 1)

Once the CDF is calculated, Table 3.2 can be used to determine the remaining life of the pavement.

**Table 3.2 – Pavement Remaining Life Based on CDF [FAA, 2009a]**

CDF Value	Pavement Remaining Life
1	The pavement has used up all of its fatigue life
< 1	The pavement has life remaining; the value of CDF gives the fraction of life used.
> 1	The pavement has exceeded its fatigue life.

### 3.3 Flexible Pavement Design

Flexible pavement refers to a pavement structure that consists of an asphalt surface placed on a base course, and possible subbase course. The pavement subgrade supports the entire flexible pavement structure [FAA, 2009a]. Figure 3.3 shows a typical plan and cross section for runway pavement, with Hot Mix Asphalt (HMA) sitting on a base course, sitting on the subbase, placed on the subgrade. Flexible pavement is designed with two assumed modes of failure: vertical strain in the subgrade (maximum at top of subgrade), and horizontal strain in the asphalt (maximum at bottom of asphalt layer) [FAA, 2009a].

#### 3.3.1 Hot Mix Asphalt Surface

FAA Design standards require surface asphalt to have a minimum thickness of 100 mm (4 inches), a Poisson's ratio of 0.35, with a fixed modulus of 1 380 MPa (200,000 psi) at a pavement temperature of 32 °C (90 °F) [FAA, 2009a]. The goal of the asphalt surface is to provide a water resistant course that protects the base course from being penetrated by water or other surface contaminants. The materials and aggregates that the asphalt surface is made from should be well bonded, to prevent Foreign Object Debris (FOD) particles from developing and damaging aircrafts or creating safety issues. In terms of performance, the asphalt surface must be able to resist the shear stresses caused by static and dynamic aircraft wheel loads and braking action. Finally, the surface should provide



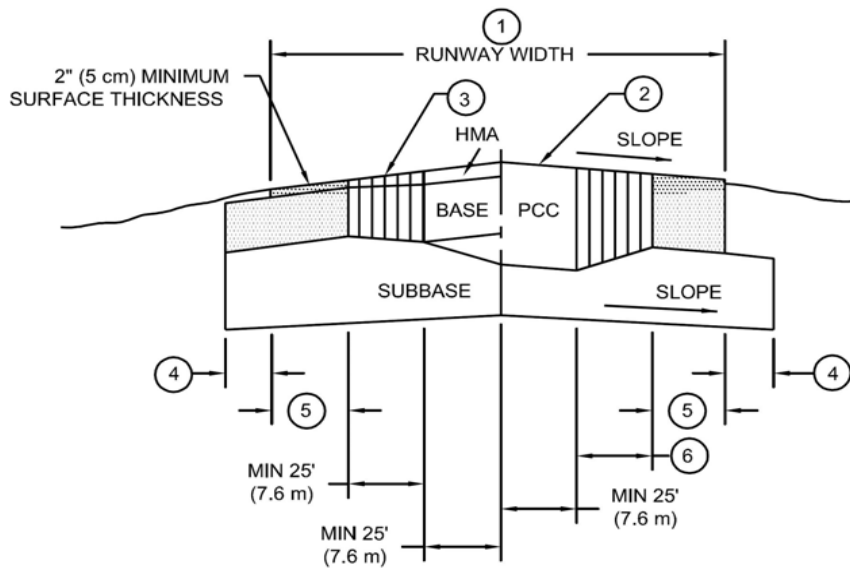
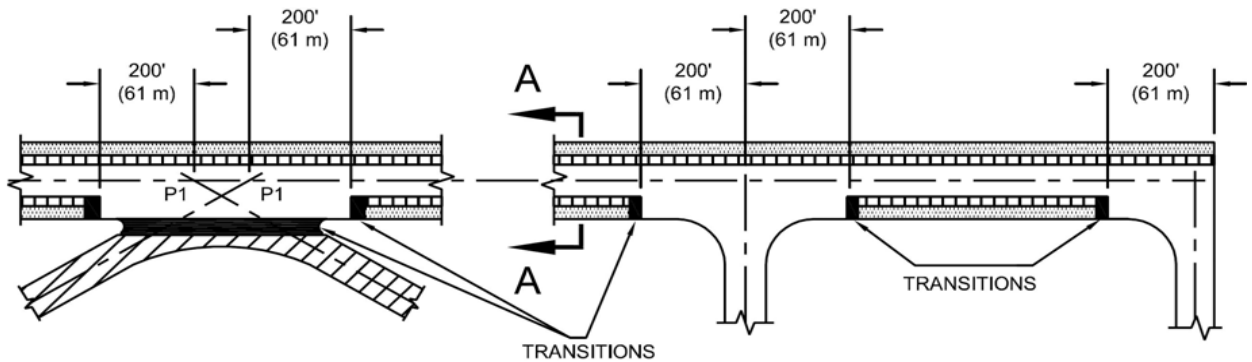

friction properties that will enable an aircraft to safely traverse the runway and stop, while not causing excessive wear on aircraft tires [FAA, 2009a].



**NOTES:**

- ① RUNWAY WIDTH IN ACCORDANCE WITH APPLICABLE ADVISORY CIRCULAR.
- ② TRANSVERSE SLOPES IN ACCORDANCE WITH APPLICABLE ADVISORY CIRCULAR.
- ③ SURFACE, BASE, PCC, ETC. THICKNESS AS REQUIRED.
- ④ MINIMUM 12" (30 cm) UP TO 36" (90 cm) ALLOWABLE.
- ⑤ THIS DIMENSION WILL INCREASE FOR RUNWAYS WIDER THAN 150' (45.7 m).
- ⑥ WIDTH OF TAPERS AND TRANSITIONS ON RIGID PAVEMENTS SHALL BE AN EVEN MULTIPLE OF SLABS, MINIMUM ONE SLAB WIDTH.

**LEGEND:**

-  FULL PAVEMENT THICKNESS (DESIGN USING 100% DEPARTURE TRAFFIC).
-  PAVEMENT THICKNESS TAPERS TO OUTER EDGE THICKNESS.
-  OUTER EDGE THICKNESS (DESIGN USING 1% DEPARTURE TRAFFIC).
-  TRANSITION.
-  DESIGN USING ARRIVAL TRAFFIC HIGH SPEED TURNOFFS AND SIMILAR.

**Figure 3.3 - Typical Plan and Cross Section for Runway Pavement [FAA, 2009a]**

### 3.3.2 Flexible Pavement Base Course

The primary function of the base course is to provide structural support and load transfer; it supports the asphalt surface and transfers the load from the surface to the subbase or subgrade if no subbase is present. In addition to supporting the asphalt surface, the base course is responsible for preventing subgrade failure while withstanding the forces generated in the base structure itself [FAA, 2009a]. Subgrade failure will eventually lead to the failure of the entire pavement structure.

The thickness of the base course and quality of the materials the base is composed of affect the ability of the base course to fulfill its role in the pavement structure. The materials must be able to resist volume changes caused by fluctuations in the subgrade moisture content and resist consolidation caused by vertical pressure from aircraft loading. Volume changes in the base course will result in distortion of the pavement structure and potentially cause failure of the asphalt surface [FAA, 2009a].

The quality of materials, composition of the subgrade and the compaction of the base course will impact the performance of the base course. The base course should be made from well compacted aggregates that are durable, hard and high quality. FAA provides guidance on the materials approved for use as base course, shown in Table 3.3.

**Table 3.3 - Suitable Base Course Materials for Flexible Pavement [FAA, 2009a]**

Item Number	Material	Category
P-208	Aggregate Base Course	Unstabilized
P-209	Crushed Aggregate Base Course	Unstabilized
P-211	Lime Rock Base Course	Stabilized
P-219	Recycled Concrete Aggregate Base Course	Unstabilized
P-304	Cement Treated Base Course	Stabilized
P-306	Econocrete Subbase Course	Stabilized
P-401	Plant Mix Bituminous Pavements	Stabilized
P-403	HMA Base Course	Stabilized

An unstabilized base course consists of just aggregate; a stabilized base course (i.e. it contains either asphalt or cement) is necessary when the runway is expected to handle jet aircrafts weighing 45 359 kg (100,000 lbs.) or more [FAA, 2009a]. Exceptions to this requirement can be made if superior material is available for the base course; superior material would be hard (such as 100% crushed, hard, closely graded stone) with a remolded soaked California Bearing Ratio (CBR) minimum of 100 [FAA, 2009a]. A stabilized base is considered either flexible or rigid, depending on the Poisson s Ratio, shown in Table 3.4 .

**Table 3.4 – Stabilized Subbase Layer Types in FAARFIELD [FAA, 2009a]**

Base Layer	Modulus, MPa (psi)	Poisson s Ratio
Stabilized (flexible)		
Variable Minimum	1 035 (150,000)	0.35
Variable Maximum	2 760 (400,000)	
P-401/403 Asphalt	2 760 (400,000)	
Stabilized (rigid)		
Variable Minimum	1 720 (250,000)	0.20
Variable Maximum	4 830 (700,000)	
P-304 Cement Treated Base	3 450 (500,000)	
P-306 Econocrete Subbase	4 830 (700,000)	

FAA also provides guidance of the minimum aggregate base course thickness, summarized in Table 3.5. The minimum base course thickness specified by the FAA is 100 mm (4 inches).

**Table 3.5 - Minimum Aggregate Base Course Thickness for Flexible Pavements [FAA, 2009a]**

Gear Type	Design Load Range		Minimum Base Course (P-209) Thickness	
	lbs.	(kg)	in.	(mm)
S	30,000 - 50,000	(13 600 – 22 700)	4	(100)
	50,000 - 75,000	(22 700 – 34 000)	6	(150)
D	50,000 - 100,000	(22 700 – 45 400)	6	(150)
	100,000 - 200,000*	(45 400 – 90 700)	8	(200)
2D	100,000 - 250,000*	(45 400 – 113 400)	6	(150)
	250,000 - 400,000*	(113 400 – 181 000)	8	(200)
2D (B757, B767)	200,000 - 400,000*	(90 700 – 181 000)	6	(150)
2D or 2D/D1 (DC10, L1011)	400,000 - 600,000*	(181 000 – 272 000)	8	(150)
2D/2D2 (B747)	400,000 - 600,000*	(181 000 – 272 000)	6	(150)
	600,000 - 850,000*	(272 000 – 385 600)	8	(200)
2D/D1 or 2D/2D1(A340)	568,000 - 840,400	(257 640 – 381 200)	10	(250)
2S (C130)	75,000 - 125,000	(34 000 – 56 700)	4	(100)
	125,000 - 175,000*	(56 700 – 79 400)	6	(150)
3D (B777)	537,000 - 777,000*	(243 500 – 352 440)	10	(250)
3D (A380)	1,239,000 - 1,305,125*	(562 000 – 592 000)	9	(230)

*\*Values are listed for reference. However, when the traffic mixture contains airplanes exceeding 45 400 kg (100,000 lbs.) gross weight, a stabilized base is required*

### 3.3.3 Flexible Pavement Subbase

The subbase is the pavement layer that exists just below the base course, and sits on the pavement subgrade. The purpose of the subbase is similar to that of the base course; it provides additional structural support to the base course and protects the subgrade. The subbase is subject to lower loading and stress and strain than the base course, and as such, the material requirements for the subbase are not as stringent as the base course [FAA, 2009a].

The subbase typically has a California Bearing Ratio (CBR) of 20 or greater, if the native subgrade has a CBR of 20 or greater, the subbase layer may not be required for the pavement structure [FAA, 2009a].

FAA provides guidance on the materials approved for use as subbase, shown in Table 3.6.

**Table 3.6 - Subbase Materials for Flexible Pavements [FAA, 2009a]**

Item Number	Material
P-154	Subbase Course
P-210	Caliche Base Course
P-212	Shell Base Course
P-213*	Sand Clay Base Course
P-301*	Soil Cement Base Course

*\* Not recommended for use where frost penetration into subbase is anticipated*

### 3.3.4 Flexible Pavement Subgrade

The pavement subgrade is in theory infinite in depth, it is the layer of the pavement structure that the subbase rests on. The subgrade is subject to the least stress in the pavement structure, typically the highest point of stress in the subgrade is at the top, and the stresses dissipate with depth. Variation in material and compaction in the subgrade may cause stress points in the subgrade, where possible weak subgrade should be removed and replaced with a better quality material or stabilized. The subgrade's ability to resist shear forces and deformation are affected by the moisture content of the soil [FAA, 2009a].

In the initial design phase, it is imperative that a soils study is performed to better understand the engineering properties of the subgrade material. Engineers should incorporate the results of the soils study in their design of the new runway pavement. It is important to check compaction levels of the subgrade structure during [FAA, 2009a].

Table 3.7 shows the minimum compaction requirements for subgrade, based on depth and the gross weight and gear configuration of aircrafts using the runway.

**Table 3.7- Subgrade Compaction Requirements [FAA, 2009a]**

GEAR TYPE	GROSS WEIGH T Lb.	NON-COHESIVE SOILS				COHESIVE SOILS			
		Depth of Compaction, inch				Depth of Compaction, inch			
		100%	95%	90%	85%	95%	90%	85%	80%
S	30,000	8	8-18	18-32	32-44	6	6-9	9-12	12-17
	50,000	10	10-24	24-36	36-48	6	6-9	9-16	16-20
	75,000	12	12-30	30-40	40-52	6	6-12	12-19	19-25
D (incls. 2S)	50,000	12	12-28	28-38	38-50	6	6-10	10-17	17-22
	100,000	17	17-30	30-42	42-55	6	6-12	12-19	19-25
	150,000	19	19-32	32-46	46-60	7	7-14	14-21	21-28
	200,000	21	21-37	37-53	53-69	9	9-16	16-24	24-32
2D (incls. B757, B767, A-300, DC- 10-10, L1011)	100,000	14	14-26	26-38	38-49	5	6-10	10-17	17-22
	200,000	17	17-30	30-43	43-56	5	6-12	12-18	18-26
	300,000	20	20-34	34-48	48-63	7	7-14	14-22	22-29
	400,000 – 600,000	23	23-41	41-59	59-76	9	9-18	18-27	27-36
2D/D1, 2D/2D1 (incl. MD11, A340, DC10-30/40)	500,000 – 800,000	23	23-41	41-59	59-76	9	9-18	18-27	27-36
2D/2D2 (incl. B747 series)	800,000	23	23-41	41-59	59-76	9	9-18	18-27	27-36
	975,000	24	24-44	44-62	62-78	10	10-20	20-28	28-37
3D (incl. B777 series)	550,000	20	20-36	36-52	52-67	6	6-14	14-21	21-29
	650,000	22	22-39	39-56	56-70	7	7-16	16-22	22-30
	750,000	24	24-42	42-57	57-71	8	8-17	17-23	23-30
2D/3D2 (incls A380 series)	1,250,000	24	24-42	42-61	61-78	9	9-18	18-27	27-36
	1,350,000	25	25-44	44-64	64-81	10	10-20	20-29	29-38

*Notes:*

1. *Noncohesive soils, for the purpose of determining compaction control, are those with a plasticity index of less than 3.*
2. *Tabulated values denote depths below the finished subgrade above which densities should equal or exceed the indicated percentage of the maximum dry density as specified in Item P-152.*
3. *The subgrade in cut areas should have natural densities shown or should*
  - (a) be compacted from the surface to achieve the required densities,*
  - (b) be removed and replaced at the densities shown, or*
  - (c) when economics and grades permit, be covered with sufficient select or subbase material so that the uncompacted subgrade is at a depth where the in-place densities are satisfactory.*
4. *For intermediate airplane weights, use linear interpolation.*
5. *For swelling soils, refer to AC 150/5320-6E paragraph 313.*
6. *1 inch = 25.4 mm, 1 pound. = 0.454 kg*

### 3.4 Rigid Runway Pavement Design

Rigid pavement refers to a runway surface that is made from Portland Cement Concrete (PCC). The PCC slab is placed on a compacted granular or treated subbase over a compacted subgrade, as shown earlier in Figure 3.3.

#### 3.4.1 Rigid Pavement Surface

In rigid pavement design, the major design constraint is the stress in the surface PCC slab; the point where the maximum horizontal stress occurs is at the bottom of the slab. In the FAARFIELD design program, the failure of the pavement subgrade and subbase layers are not considered, instead the concrete layer thickness is iterated until the CDF reaches a value of 1.0 [FAA, 2009a].

Similar to an asphalt surface, in a flexible pavement the concrete surface must provide adequate friction and be textured sufficiently to promote good drainage, without causing undue wear on aircraft tires. The pavement must be able to support the dynamic and static loads of aircrafts and other vehicles using the runway. The FAA provides guidance for concrete quality and workmanship in Item P-501, Portland Cement Concrete [FAA, 2009a].

#### 3.4.2 Rigid Pavement Subbase

According to the FAA design guidelines, the subbase must be a minimum thickness of 100 mm (4 inches), and provide uniform and stable support to the overlaying concrete slab [FAA, 2009a]. The subbase should be thicker than 100 mm (4 inches) if the materials used for constructing the subbase are not high quality.

FAA provides guidance on the materials approved for use as subbase, shown in Table 3.8.

**Table 3.8 - Rigid Pavement Subbase Materials [FAA, 2009a]**

Item Number	Material
P-154	Subbase Course
P-208	Aggregate Base Course
P-209	Crushed Aggregate Base Course
P-211	Lime Rock Base Course
P-301	Soil Cement Base
P-304	Cement Treated Base Course
P-306	Econcrete Subbase Course
P-401	Plant Mix Bituminous Pavements
P-403	HMA Base Course

A stabilized subbase is required for runways that will accommodate aircrafts weighing 45 359 kg (100,000 lbs.) or more. Table 3.9 shows the FAA's list of acceptable stabilized subbase materials.



**Table 3.9 – Stabilized Rigid Pavement Subbase Materials [FAA, 2009a]**

<b>Item Number</b>	<b>Material</b>
P-304	Cement Treated Base Course
P-306	Econocrete Subbase Course
P-401	Plant Mix Bituminous Pavements
P-403	HMA Base Course

### **3.5 Foreign Object Debris**

Foreign Object Debris (FOD) is any item on the runway surface that potentially could interfere with the safe operation of an aircraft. FOD can cause catastrophic events that endanger passengers, airport staff, and communities surrounding the runway. FOD ranges in size, from small items such as loose aggregate and nails, to larger items such as suitcases and airport maintenance or operations equipment. FOD can be sucked into the aircraft engine, potentially causing catastrophic damage to the aircraft and its passengers. Runways must be regularly monitored for FOD. When FOD is found it must be removed immediately.

### **3.6 Airport Pavement Management Systems (APMS)**

An Airport Pavement Management System (APMS) is a tool that airport owners and managers can use to keep an inventory of their pavement and enables them to make planning decisions about pavement maintenance, preservation, rehabilitation and reconstruction. By collecting, inputting and analyzing data, an APMS can be used to monitor and predict pavement performance, and create a schedule of maintenance and repairs. An APMS can be effectively used to manage airport budgets and optimize the process of making project funding decisions. A well designed APMS can encompass information about all airport pavements, including runways, taxiways, aprons and service roads.

Maintaining an APMS involves regular monitoring of the pavement condition and performing tests to collect data regarding pavement characteristics such as surface distress, pavement friction, roughness and contaminant accumulation. The introduction of APMS has enabled long term strategic planning for pavement related decisions at airports. Historically, decisions regarding pavement maintenance, preservation and rehabilitation were made based on best engineering practices and experience based engineering judgment. With an APMS in place, decision makers can use modeling tools to forecast the rate of pavement deterioration, and accordingly allocate funds in the maintenance and rehabilitation budget to maintain a high level of service for all airport pavements.

#### **3.6.1 Key Features of an APMS**

APMS can be developed to encompass information at the network level and at the project level. At the network level, the APMS can be used for short and long term budget planning, to identify problematic pavement sections, and rank funding and maintenance priorities within the network of airport pavements. The network level is less detailed; it provides users with an overview of the overall pavement condition for different pavement assets.

The project level is more detailed; it contains information about specific sections, tasks and treatments. The project level provides planners with appropriate information that can be used for economical decision making. The project level contains detailed records of pavement condition surveys including condition assessments, and results from data collection. The project level may include results from friction tests, roughness tests, deflection and non-destructive tests and core samples [Tighe, 2008].

### 3.6.2 Advantages of using an APMS

The primary function of an APMS is to provide organized documentation and a comprehensive inventory of the pavement and its condition over time. As such, one of the major advantages of an APMS is that pavement information is organized and stored in a centralized location that is easily accessible. Storing the data in a centralized location makes it easy to update pavement condition information, and easy to find and access the most current information regarding pavement condition. As well, by creating a database of pavement information, analysts can identify trends in pavement performance, and identify problematic areas. Understanding pavement performance trends also enables airport owners and managers the ability to develop effective maintenance, preservation and rehabilitation treatment schedules, prioritize projects and optimize resource allocation.

An APMS can also be used to determine the most cost effective point in the pavement's life to perform a rehabilitation treatment. Figure 3.4 shows the typical airport pavement condition deterioration over the design life, and how the cost of rehabilitation increases significantly as the pavement condition deteriorates from fair condition to a failed condition.

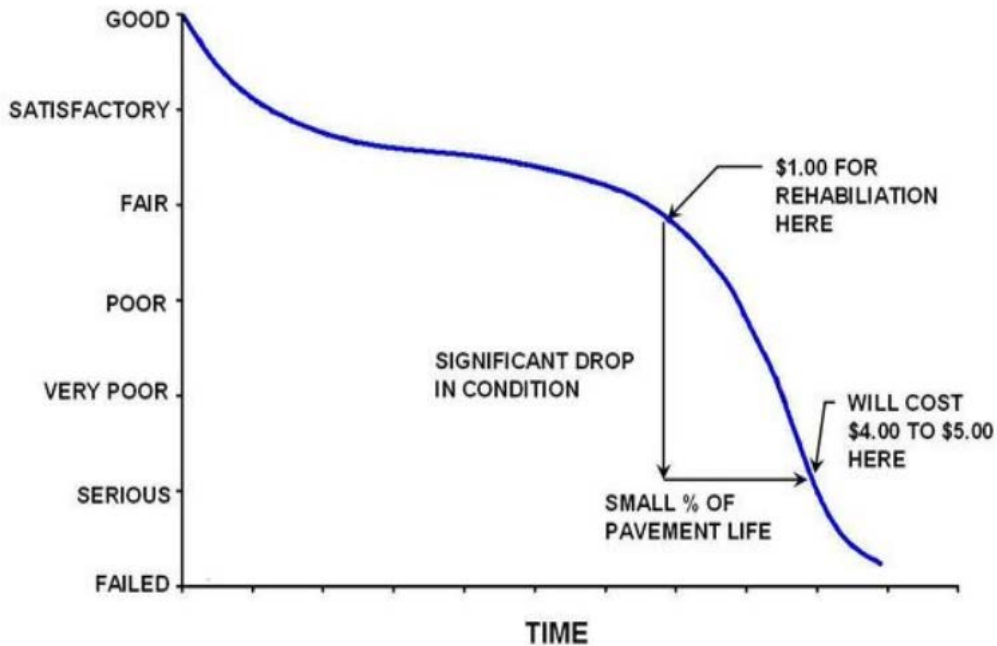

Figure 3.4 Pavement Condition Life Cycle [FAA, 2011a]

Studying pavement life cycle and monitoring the pavement condition using an APMS can help airport managers select the optimal time to perform pavement treatments and assists in maximizing pavement life expectancy and condition while minimizing cost.

### **3.6.3 Costs associated with an APMS**

Costs associated with implementing an APMS can be divided into initial startup costs and reoccurring maintenance costs. Startup costs include purchasing hardware, software and relevant licenses for the APMS, or the cost of developing the APMS if completed in house. Some airports choose to hire consultants to set up their APMS; others will use a team of in house specialists to develop the APMS [Tighe, 2008].

One of the key requirements for the APMS to maintain functionality is providing adequate and frequent training to APMS users. Training must be provided for individuals collecting and inputting data, and individuals utilizing and analyzing the data within the APMS. Ongoing costs include providing initial and refresher courses to teach users how to use the APMS, as well as the labour costs associated with data collection and maintaining the APMS.

## **3.7 Chapter Summary**

This chapter discussed the pavement design guidelines as it pertains to airport runways. Guidelines for constructing both rigid pavement and flexible pavement were presented. The design of the runway surface should provide water resistance that protects the pavement subgrade, and distributes stress and loading through the underlying pavement structure. In addition, the pavement surface must be well bonded to prevent FOD from developing.

Aircraft factors that must be considered when designing a runway include: aircraft size, weight and landing gear tire configurations. These factors affect how the pavement will respond to repetitive loading and how the distresses will manifest in the pavement over time. Characteristics of the aircraft traffic distribution, such as percentage of heavy aircrafts and volume of aircrafts landing must also be included in pavement design. The pavement structure must be able to resist the shear stress caused by aircraft dynamic loading.

An APMS is a tool that tracks pavement inventory and stores data regarding pavement condition. APMS can be utilized by airport managers to schedule the most economical period to perform maintenance, preservation and rehabilitation treatments to maintain a good pavement level of service.

### **3.7.1 Chapter Key Points**

Properly engineered runway pavement design and management is important for:

- Providing a surface with good riding quality characteristics and adequate friction for safely stopping an aircraft.
- Preventing FOD generated from the pavement surface failing.
- Tracking pavement assets, the condition of pavement and determining the most economical time to perform maintenance to maintain a pavement quality.

## **Chapter 4**

### **Rubber Contaminated Runways and Rubber Removal Techniques**

This chapter is directed at evaluating various methods of removing rubber from typical northern climate airport runways that experience rubber contamination.

#### **4.1 Pavement Texture**

When landing an aircraft, or in a rejected take-off situation, pilots rely on the runway pavement being in good working condition so that they can safely stop their aircraft. The surface characteristics of the runway are important for the pilot to maintain control of the aircraft and safely stop within the length of the runway. One of the criteria for the pavement to be considered in good working condition is to exhibit an adequate level of friction. The pavement macrotexture and microtexture contribute to the overall friction of the pavement.

There are two factors that are known to rapidly accelerate the reduction in skid resistance of a runway pavement: polishing of aggregate in the pavement surface from repeated use, and accumulation of contaminants, primarily rubber from aircraft tires. Rubber accumulation will fill the voids in the pavement macrotexture and microtexture, creating a smooth surface that becomes especially slick when wet. The rate of rubber build up and the rate of polishing of aggregates are directly proportional to the volume of landings and the size and weight of aircrafts [AFCEA, 2004]. However, weather also impacts the rubber accumulation rate.

#### **4.2 Rubber Build up**

When an aircraft lands on a runway, rubber is deposited from the braking action of the tire onto the runway, usually in a fine layer near the touchdown point. A typical aircraft landing can leave a finely spread layer of rubber on the runway weighing approximately 700 g [ACRP, 2008b]. Rubber buildup from aircraft landings primarily accumulates in a 300 m area near the touchdown point on the runway, although it may extensively cover an actively used runway [Speidel, 2002].

When an aircraft is landing, the wheels are stationary prior to touchdown. Upon touchdown, the landing wheels gain rotational speed to match the speed of the aircraft, and the tires are under high pressure as the load of the aircraft is transferred from the wings keeping the aircraft flying to the landing gear reaction forces on the ground. This process is called spin up speed, and it generates considerable heat and friction. The heat and friction generated during the landing causes a reaction that polymerizes the wheel rubber, changing it from a soft, load absorbing rubber to a hard, dense rubber that is finely spread on the runway [Speidel, 2002].

Rubber accumulation on a dry runway is generally not a problem since the rubber interaction between the aircraft tire and the rubber on the runway creates traction that may actually improve friction. However, in wet conditions, rubber accumulation leads to loss of friction on the runway by clogging the pavement texture and creating an especially slick surface with minimal drainage capability when the runway surface is wet. Additionally, rubber accumulation causing decreased friction values means pilots have less directional control of the aircraft than expected on a bare and dry runway.

### 4.3 Friction Testing to Measure the Impact of Rubber

As a component of maintaining safe operations on a runway, rubber deposits must be monitored and removed frequently to ensure adequate friction is available for braking aircrafts, especially during wet conditions. Friction tests can be performed by the airport using an approved Continuous Friction Measuring Equipment (CFME) Tester. Friction tests can also be contracted out to third party agencies that bring CFME testers to the airport to conduct a friction survey. Even if friction measurements are adequate, rubber removal may also be required if rubber buildup obscures the visibility of pavement markings. Figure 4.1 shows rubber buildup on a runway and how pavement markings can be obscured by rubber accumulation.

Rubber build up needs to be removed from the runway when friction tests indicate the runway does not have an adequate level of friction for safe operation, and when rubber obstructs pavement markings, as this may also cause safety concerns for aircrafts traversing the runway.



**Figure 4.1 - Rubber Buildup on a Runway [Bangkok, 2008]**

#### 4.3.1 State of Practice: Frequency of Friction Tests

Airport operators should perform routine friction tests to determine the impact rubber buildup has on the friction characteristics of the runway. The frequency of performing friction tests is dictated by the volume of traffic and the types of aircrafts landing. An airport with a high volume of aircraft landings needs to perform friction tests more frequently than an airport with few daily aircraft landings. The

type of aircrafts landing also affects the frequency of testing required; an airport that sees a lot of large and heavy wide body aircrafts landing requires more frequent testing than an airport that rarely has large aircrafts landing.

Table 4.1 shows the recommended minimum frequency for runway friction testing. The recommended minimum frequency for testing shown in Table 4.1 is indicated for runways with less than 20% heavy aircrafts, and more frequent testing for runways with more than 20% heavy aircrafts landing in their daily traffic. The runway should be tested from both approach ends, e.g. Runway 09-27 should be separately tested as Runway 09 and Runway 27.

**Table 4.1 – Minimum Frequency for Friction Testing [AFCESA, 2004 and Speidel, 2002]**

<b>Number Of Daily Minimum Aircraft Landings Per Runway End</b>	<b>Minimum Friction Testing Frequency &lt; 20% Heavy Aircrafts</b>	<b>Minimum Friction Testing Frequency &gt; 20% Heavy Aircrafts</b>
Less than 15	1 year	6 months
16 to 30	6 months	3 months
31 to 90	3 months	1 month
91 to 150	1 month	2 weeks
151 to 210	2 weeks	1 week
Greater than 210	1 week	< 1 week

#### **4.3.2 State of Art: Frequency of Friction Tests**

As the airport collects data from ongoing performance friction tests, the airport operators can develop a friction database for incorporation into their pavement management system (PMS). Once this data is available, the airport managers and operators can determine trends in the accumulation of rubber, which can subsequently be used to schedule the frequency of friction tests and rubber removal. The airport can incorporate factors such as the number of landings, landing aircraft weight, distribution of heavy versus light aircrafts, frequency of landings per direction on a runway and wind and weather patterns that require aggressive braking leading to greater rubber buildup in their PMS.

As trends become evident in the data, the airport operators can tailor the scheduling of friction tests and rubber removal to optimize runway performance. Optimizing the frequency of runway friction tests and rubber removal may improve runway safety, as the pavement management system may identify tests and removals are required more frequently than state-of-practice tests indicate. Optimizing the frequency of friction tests and rubber removal may also lead to cost savings if trends in the pavement management system show a more efficient schedule for these tests, leading to fewer or shorter runway closures for testing and maintenance.

#### **4.4 Rubber Removal**

There are four primary methods for removing rubber buildup. These include: waterblasting, shotblasting, chemical removal and mechanical removal. Waterblasting is a process that removes

rubber using a high pressure spray of water. Shotblasting is a rubber removing process where an abrasive material is machine blasted onto the runway pavement. Chemical removal involves using a chemical agent or detergent to soften and break down the rubber build up so it can be removed by a broom or vacuum. Finally, mechanical removal is any process not covered by shotblasting, Waterblasting or chemical removal and may include scraping, grinding, milling or sandblasting to remove rubber buildup [ACRP, 2008b].

#### 4.5 Rubber Removal by Chemical Agents

The concept behind using chemical agents to remove rubber is to apply a compound (often called a detergent) to the runway that will soften the dense rubber. After application, the chemical agent/surfactant is allowed to permeate into the accumulated rubber. The rubber and detergent are then removed by rinsing or brushing debris off the runway. Traditionally, the rubber is washed off the runway, onto the shoulder or soil adjacent to the runway. The rubber may be buried or left unattended until accumulation is large enough to merit an environmental removal. Removing rubber using chemicals was the industry standard prior to the 1970's, when concern regarding the environmental impact on local watersheds brought the practice into question. Since then, new biodegradable environmentally inert compounds have been developed for softening runway rubber buildup, however, there is still concern about the disposal of the rubber as the rubber itself is not biodegradable and may contain toxins [Speidel, 2002].

##### 4.5.1 Application Rate and Cost of Chemical Agents

The process speed for removing rubber using a chemical agent ranges from 743 m<sup>2</sup>/ h (900 yd<sup>2</sup>/ h) to 1641 m<sup>2</sup>/ h (1950 yd<sup>2</sup>/ h) [after ACRP, 2008b].

The adjusted 2012 unit costs for rubber removal by chemical agents are summarized in Table 4.2. The information provided in Table 4.2 is based on a survey the Airport Cooperative Research Program conducted with data collected from Airports across North America.

**Table 4.2 – Reported Chemical Rubber Removal Unit Costs [after ACRP, 2008b]**

Low	Mean	High
\$0.16/m <sup>2</sup> (\$0.13/yd <sup>2</sup> )	\$0.52/ m <sup>2</sup> (\$0.43/ yd <sup>2</sup> )	\$1.43/ m <sup>2</sup> (\$1.20/ yd <sup>2</sup> )

##### 4.5.2 Advantages of Chemical Agents

Chemical agents soften the rubber on the runway, resulting in minimized pavement damage [ACRP, 2008b]. The second advantage of using a chemical agent for rubber removal is that the process does not require specialized equipment or unique labour. Traditionally, chemical agents can be applied by airport staff, as many airports already own the appropriate equipment and current airport maintenance staff can apply a chemical agent for rubber removal. The process can also be carried out in sections, and during off peak hours, which makes it user friendly. Although the chemical compounds required for rubber removal are expensive, many airports found the cost savings associated with completing rubber removal in-house often offset the cost of the purchasing the chemical compounds. Lastly, new

chemical compounds that are used for rubber removal are biodegradable and environmentally benign and may not require a permit for their use [ACRP, 2008b].

#### **4.5.3 Disadvantages of using Chemical Agents**

In contrast to other methods, a major disadvantage of using chemical agents is that once the process begins, the runway must remain closed until completely it is completely cleaned. Depending on the extent of the rubber buildup, the chemical agent generally requires 4 – 5 hours to permeate the rubber. During this time, complete closure is necessary because the chemical compound makes the rubber slippery and gel like, providing an unsafe surface for aircrafts to land on. This disadvantage is particularly relevant in military airfields, when an airport may have to deal with an emergency aircraft landing.

Although modern surfactants used to soften rubber are considered biodegradable, the debris and residue generated from rubber removal often requires to be treated as hazardous waste that must be removed and disposed in accordance with environmental regulations [ACRP, 2008b].

While one of the advantages of using chemical agents to remove rubber is that many airports already own equipment that can be used for rubber removal, one of the disadvantages is that equipment may deteriorate more rapidly if it is not resistant to the rubber decomposing effects of the chemicals being used. The rubber removing equipment may require additional maintenance and frequent replacement of parts that interact with or are exposed to the chemical compounds.

Another possible (though not conclusively proven) disadvantage identified in literature, is that chemical compounds may damage the runway pavement (asphalt surfaces in particular), and may not adequately remove from groves to restore the pavement macrotexture [ACRP, 2008b].

The final disadvantage of this method is the higher cost associated with the purchasing the surfactants; waterblasting only requires water which is often available at no additional cost [Speidel, 2002].

#### **4.6 Rubber Removal by Waterblasting**

Rubber removal by waterblasting has gained popularity in North America as a more environmental alternative to removing rubber using chemical agents. Waterblasting involves using a high pressure stream of water to blast and peel the rubber off the runway. Waterblasting units can be operated by one individual and are often self-contained, in that the waterblasting truck also includes a vacuum which removes the debris immediately following the water jets. The vacuum simultaneously cleans the water, rubber and any other debris from the runway. These vacuums operate in tandem with the waterblasting unit; eliminate the risk of runoff from the rubber removal process. Waterblasting does not require any additives or additional chemicals to facilitate rubber removal. The waterblasting unit often separates debris and waste water without requiring flocculants, allowing for easier disposal.

##### **4.6.1 Processing Rate and Unit Cost of Rubber Removal by Waterblasting**

Waterblasting units are either classified as high pressure, applying pressure from 13.8 MPa (2000 psi) to 103 MPa (15000 psi) using up to 114 L (30 US Gallons) of water per minute; or ultrahigh pressure, with up to 276 MPa (40000 psi) of pressure using 30 L (8 US gallons) of water per minute [Speidel,



2002]. In both cases, the process speed is the same, approximately 743 m<sup>2</sup>/ h (900 yd<sup>2</sup>/ h) to 1641 m<sup>2</sup>/h (1950 yd<sup>2</sup>/ h) [after ACRP, 2008b].

The adjusted 2012 unit costs for rubber removal by waterblasting are summarized in Table 4.3. The information provided in Table 4.3 is based on a survey the Airport Cooperative Research Program conducted with data collected from Airports across North America.

**Table 4.3 – Reported Waterblasting Rubber Removal Unit Costs [after ACRP, 2008b]**

	<b>Low</b>	<b>Mean</b>	<b>High</b>
Airport Cost	\$0.31/m <sup>2</sup> (\$0.26/yd <sup>2</sup> )	\$0.54/m <sup>2</sup> (\$0.44/yd <sup>2</sup> )	\$3.24/m <sup>2</sup> (\$2.71/yd <sup>2</sup> )
Contractor Cost	\$0.39/m <sup>2</sup> (\$0.50/yd <sup>2</sup> )	\$1.20/m <sup>2</sup> (\$1.00/yd <sup>2</sup> )	\$4.05/m <sup>2</sup> (\$3.39/yd <sup>2</sup> )

The ACRP study notes the small sample size in the data collection, and indicates that the values shown in Table 4.3 should be considered descriptive, not conclusive [ACRP, 2008b].

#### **4.6.2 Advantages of Waterblasting**

Rubber removal by using waterblasting equipment has several major advantages. One of the biggest advantages of cleaning by waterblasting is that the technique cleans the runway, removing all residues and restoring the pavement’s microtexture and macrotexture. Restoring the pavement’s texture helps provide necessary friction qualities to the pavement. Using a high pressure waterblasting truck has a low probability of causing damage to pavement; for this reason many airport operators choose to utilize waterblasting as their primary means of removing rubber buildup [ACRP, 2008b].

Another benefit of the waterblasting process is that the operation is quick, and involves a self-contained unit that can be operated by one person. Because vacuuming the runway is a component of waterblasting, the technique has low risk of leaving FOD behind on the runway. Since the waterblasting process is instantaneous, from spraying water that removes rubber to sucking up residue, the waterblasting equipment can be off the runway in a moment’s notice, if it is necessary for the runway to re-open to accommodate an emergency aircraft landing. While waterblasting may remove runway paint markings, in good weather conditions, the runway will be ready within half an hour of the rubber removal for paint application [Airport, 2011].

Since the process does not require any chemical additives to pre-treat the rubber or any flocculants to separate the rubber from the waste water, the process is generally considered an environmental option. Most airports do not need to acquire an environmental permit for rubber removal by waterblasting, although they will need to dispose the waste products in accordance with environmental regulations, as it may contain heavy metals such as zinc and other non-biodegradable toxins [ACRP, 2008b].

The waterblasting technique can be completed by airport technicians or by hired contractors. Often water for rubber removal is supplied to contractors at no additional cost, whereas chemicals would need to be purchased for removing rubber by chemical means.

### 4.6.3 Disadvantages of Waterblasting

One of the disadvantages of waterblasting is the risk of polishing aggregates if the ultrahigh pressure waterblasting technique is employed. While ultrahigh pressure waterblasting uses a considerably reduced amount of water, the higher pressure has been noted to remove some of the microtexture of the pavement. Some airports also reported groove damage after waterblasting, although it was not immediately clear whether waterblasting caused the damage, or age and use of the pavement [ACRP, 2008b].

Additionally, the waterblasting technique is often employed in the beginning of the spring and end of the summer seasons for airports located in colder climates, as shown in Figure 4.2. This trend could be because airports remove winter buildup in the spring in preparation for anticipated higher volumes of traffic in the summer, and then remove rubber buildup at the end of the busy summer period. Very few northern airports opt to perform waterblasting during winter months; snow and ice removal is a far more pressing concern.

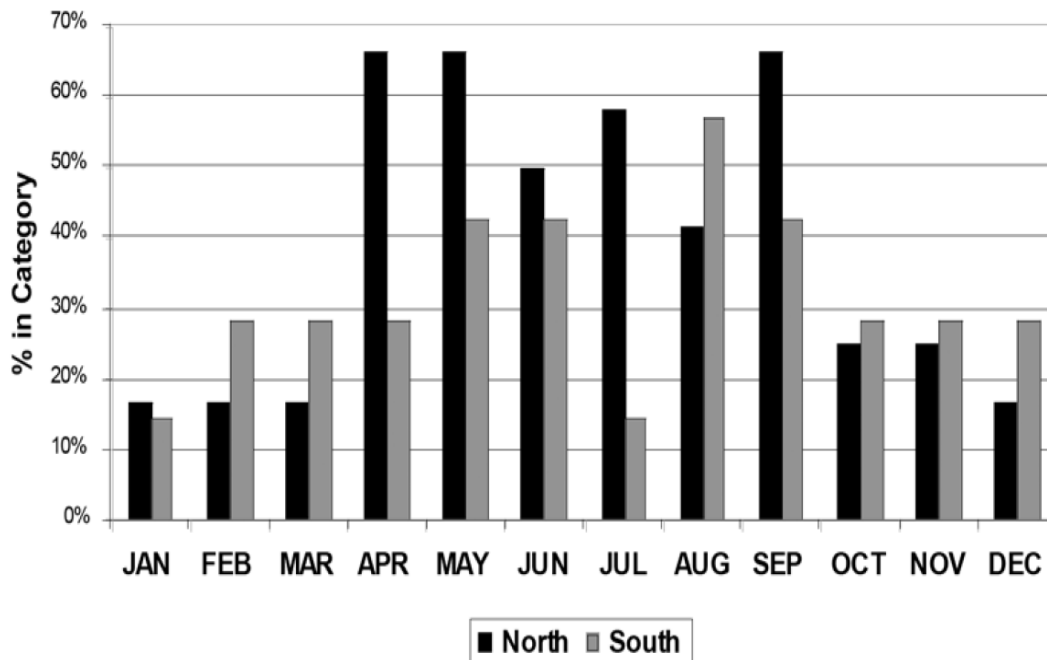

**Figure 4.2 - Waterblasting Seasonality for Northern and Southern Airports from a Survey of North American Airports [ACRP, 2008b]**

### 4.7 High Velocity Impact Rubber Removal

High Velocity Impact Removal (HVIR), more commonly known as Shotblasting or shot peening removes rubber buildup by shooting steel balls at the pavement surface. Shotblasting is generally not employed for the primary purpose of rubber removal, it is employed when the runway needs to be resurfaced, and as a secondary benefit, the process removes rubber buildup. Shotblasters use vacuums and magnets to retrieve debris from the runway, separating the steel balls from rubber, pavement and removed paint so the steel balls can be continuously reused.

#### 4.7.1 Process Speed and Unit Cost of Shotblasting

The process speed for removing rubber by shotblasting ranges from 929 m<sup>2</sup>/ h (1111 yd<sup>2</sup>/ h) to 2700 m<sup>2</sup>/ h (3588 yd<sup>2</sup>/ h) [after ACRP, 2008b].

The 2012 adjusted unit costs for rubber removal by shotblasting are summarized in Table 4.4. The information provided in Table 4.4 is based on a survey the Airport Cooperative Research Program conducted with data collected from Airports across North America.

**Table 4.4 – Reported Shotblasting Rubber Removal Unit Costs [after ACRP, 2008b]**

Low	Mean	High
\$0.60/m <sup>2</sup> (\$0.49/yd <sup>2</sup> )	\$1.05/m <sup>2</sup> (\$0.88/yd <sup>2</sup> )	\$1.79/m <sup>2</sup> (\$1.50/yd <sup>2</sup> )

#### 4.7.2 Advantages of High Velocity Impact Rubber Removal

Similar to waterblasting, high velocity impact rubber removal is hailed for its environmental nature because no chemicals are required in the process. Since there are no chemicals being added to the runway, and because the unit is self-containing with a vacuum and magnet cleaning up debris as the machine works, the shotblasting equipment can be removed from the runway fairly quickly if the airport needs to reopen the runway to accommodate an emergency landing. As the primary purpose of shotblasting is to retexture the runway, an improved runway surface is a clear advantage of using this method for rubber removal.

#### 4.7.3 Disadvantages of High Velocity Impact Rubber Removal

A major disadvantage of this technique is the risk of foreign object debris (FOD) by a steel ball implanting into the pavement during the blasting process. As noted earlier, FOD is a major concern for airport operators and managers. The same rubber disposal issue exists as with rubber removal by water blasting; the rubber is toxic and must be disposed in accordance with environmental standards.

Another disadvantage is possible pavement damage and damage to runway pavement appurtenances. The most common damage to pavement is groove edge damage and paint removal. This method requires the pavement to be structurally overdesigned and constructed with additional pavement thickness to account for the reduction in the pavement structure over time. One of the limitations of this cleaning method is that it must be performed when the runway is dry or slightly damp, and must stop if it begins to rain [ACRP, 2008b].

The potential for using high velocity impact rubber removal must be accounted for in the pavement design. Shotblasting removes thickness from the pavement surface layer, therefore, pavement must be structurally overdesigned and built when initially constructed. The overdesign of the pavement structure is necessary to account for the loss of thickness, possible structural damage and decrease in overall pavement structure caused by retexturing the runway using shotblasting.

Finally, shotblasting is an expensive cleaning technique; the equipment and material are difficult to operate and mobilize [ACRP, 2008b].

## 4.8 Rubber Removal by Mechanical Means

Rubber removal by mechanical means is the least common method of removing rubber; literature and data regarding this method is very sparse. Removal by mechanical means includes any method not encompassed by waterblasting, shotblasting or chemical removal. Mechanical removal includes (but is not limited to): scraping, using steel rotary brooms, sand blasting and using milling machines. The advantages of removing rubber by mechanical means are improved surface friction, profiling and removing surface irregularities and the ability to use existing equipment such as sweepers with steel brushes [ACRP, 2008b]. The disadvantages of mechanical rubber removal are possible groove damage, microcracking of pavement structure, accelerated aging of pavement surface, slow processing rate and as always, environmental disposal of rubber [ACRP, 2008b]. Similar to shotblasting, pavement using mechanical rubber removal must be overdesigned and over constructed.

## 4.9 Decision Making Using an Analytical Hierarchy Process

Table 4.5 shows a decision making matrix that has been developed for this research and can be incorporated into an APMS to compare the four alternatives for removing rubber from the runway.

**Table 4.5 - Decision Making Matrix for Selecting Rubber Removal Technique**

CRITERIA	WEIGHT (0-100%)	SCORE (0-10)	WEIGHTED SCORE
<b>Cost</b> <ul style="list-style-type: none"> <li>• Start-up cost</li> <li>• Lost revenue for runway closure</li> <li>• Cost of operation</li> <li>• Equipment maintenance cost</li> </ul>	$w_1$ $w_2$ $w_3$ $w_4$	$x_1$ $x_2$ $x_3$ $x_4$	$w_1x_1$ $w_2x_2$ $w_3x_3$ $w_4x_4$
<b>Accessibility</b> <ul style="list-style-type: none"> <li>• Ease to learn cleaning technique</li> <li>• Availability of skilled workers</li> <li>• Availability of equipment and materials</li> </ul>	$w_5$ $w_6$ $w_7$	$x_5$ $x_6$ $x_7$	$w_5x_5$ $w_6x_6$ $w_7x_7$
<b>Pavement</b> <ul style="list-style-type: none"> <li>• Damage to pavement</li> <li>• Texture of pavement after cleanup</li> <li>• Additional work required to bring pavement to adequate level of service</li> </ul>	$w_8$ $w_9$ $w_{10}$	$x_8$ $x_9$ $x_{10}$	$w_8x_8$ $w_8x_9$ $w_{10}x_{10}$
<b>Environmental</b> <ul style="list-style-type: none"> <li>• Permits required</li> <li>• Environmental damage</li> </ul>	$w_{11}$ $w_{12}$	$x_{11}$ $x_{12}$	$w_{11}x_{11}$ $w_{12}x_{12}$
<b>Additional Considerations</b> <ul style="list-style-type: none"> <li>• Airport specific concerns</li> </ul>	$w_{13}$	$x_{13}$	$w_{13}x_{13}$
<b>TOTAL</b>	$\sum w_x = 100\%$	<i>n/a</i>	$\sum w_x c_x$

Table 4.5 is an example of an Analytical Hierarchy Process (AHP) that can be used to assist airport operators and managers in creating relative rankings of different rubber removal techniques. Based on the specific Airport's needs, budget and priorities the Airport operators and managers can use an AHP decision making matrix similar to the one shown in Table 4.5 to select the best rubber removal technique.

To use Table 4.5 as a decision making tool, airport operators must first identify relevant criteria and assign a respective weight to each of the criteria based on their priorities. The sum of the criteria weights must total 100%.

Next, the operators must assign a score to each of the factors. The decision making matrix is established to select the best alternative, or the alternative with the highest cumulative score. Scores assigned to each factor must reflect positive attributes with a high score and negative attributes with a low score. For example, if cost is the factor considered, an alternative with a high start-up cost may receive a low score (e.g. 2) whereas an alternative with a lower start-up cost would receive a higher score (e.g. 4). For binary decisions (e.g. technique requires a permit) the operator can assign a score of 0 or 4; they would assign 0 for a perceived negative and 4 for a perceived positive factor.

Airport operators can use Table 4.5 to determine which rubber cleaning technique is most suited to meet their airport's needs. The operator can also perform a sensitivity analysis on each of the variables by changing the weight of each factor. Performing a sensitivity analysis will identify which factors are most important in the decision making process.

The alternative with the highest score, as determined by the sum of the product of all factor weights and factor scores, is the best alternative.

#### **4.10 Applying the AHP to a Low Volume Airport**

The following is an example to illustrate how an AHP can be used by an airport to facilitate selection of the best alternative for runway rubber removal. The example is based on an airport with low volume of heavy aircraft traffic, similar to the Region of Waterloo International Airport.

The first step in the AHP process is to identify the alternatives that can be used for the task. The task at hand is rubber removal, and at this particular airport the four available alternatives are: chemical, waterblasting, shotblasting and mechanical.

The second step is to identify the relevant criteria that will be used in decision making. The airport may use the criteria provided in Table 4.5 or they may elect to create their own criteria. For simplicity, the airport chose to use the criteria provided in Table 4.5, and add airport specific concerns in the additional concerns section. At this particular airport, the ability to reopen a runway during the rubber removal process is a concern of the airport operators. An additional component to this step requires assigning a weight to each of the criteria. The sum of the weight assigned to all criteria must equal 100%.

The next step is to assign a score for each of the alternatives, as shown in Table 4.6. The example shows how scores can be assigned, by ranking each of the alternatives relative to each other and assigning high, medium and low scores based on the relative ranking. For example, start up cost of the four alternatives may be ranked in descending order: chemical, shotblasting, water removal,

mechanical. Since a lower startup cost is preferred, mechanical would have the highest score of 4, and chemical would receive the lowest score of 1. Alternatively, scores can also be assigned absolutely, whereby the decision makers assign a score out of 4 regardless of how other alternatives fare relative to each other. For binary decisions, such as requiring a permit, the score assigned should be either 0 or the maximum value, in this case 4. In the binary case, the score of 0 or the maximum score may be assigned to one or more alternatives.

Once the criteria scores have been assigned to each of the four alternatives, the AHP tool will multiply the criteria weights and the criteria scores, and calculate the total score by adding the product of the individual weights and scores. Finally, the AHP tool will determine category subtotals and then a total score for each alternative. The alternative with the highest score is the most favourable option. In the example shown in Table 4.6, the most favourable alternative is to use waterblasting. It is notable that the selection priority is shotblasting, mechanical removal and lastly, chemical removal.

**Table 4.6 – Application of the AHP Decision Making Tool Example**

<i>Example Airport</i>		<i>Chemical</i>		<i>Waterblasting</i>		<i>Shotblasting</i>		<i>Mechanical</i>	
<b>CRITERIA</b>	<b>Weight (0-100%)</b>	<b>Score (0-10)</b>	<b>Wtd. Score</b>	<b>Score (0-10)</b>	<b>Wtd. Score</b>	<b>Score (0-10)</b>	<b>Wtd. Score</b>	<b>Score (0-10)</b>	<b>Wtd. Score</b>
<b>Cost</b>									
Start-up Cost	10%	1	0.1	3	0.3	2	0.2	4	0.4
Lost revenue for runway closure	10%	1	0.1	4	0.4	4	0.4	3	0.3
Cost of operation	15%	4	0.6	3	0.45	1	0.15	2	0.3
Equipment maintenance cost	5%	1	0.05	3	0.15	2	0.1	4	0.2
<b>COST SUBTOTAL</b>	<b>40%</b>		<b>0.85</b>		<b>1.3</b>		<b>0.85</b>		<b>1.2</b>
<b>Accessibility</b>									
Ease to learn cleaning technique	3%	1	0.03	4	0.12	2	0.06	3	0.09
Availability of skilled workers	3%	4	0.12	1	0.03	3	0.09	2	0.06
Availability of equipment and materials	4%	3	0.12	2	0.08	1	0.04	4	0.16
<b>ACCESSIBILITY SUBTOTAL</b>	<b>10%</b>		<b>0.27</b>		<b>0.23</b>		<b>0.19</b>		<b>0.31</b>
<b>Pavement</b>									
Damage to Pavement	10%	3	0.3	4	0.4	2	0.2	1	0.1
Texture of pavement after cleanup	10%	1	0.1	3	0.3	4	0.4	2	0.2
Additional work required for adequate LOS	10%	1	0.1	3	0.3	4	0.4	2	0.2
<b>PAVEMENT SUBTOTAL</b>	<b>30%</b>		<b>0.5</b>		<b>1</b>		<b>1</b>		<b>0.5</b>
<b>Environmental</b>									
Permits required	5%	0	0	4	0.2	4	0.2	4	0.2
Environmental damage	10%	1	0.1	4	0.4	2	0.2	3	0.3
<b>ENVIRONMENTAL SUBTOTAL</b>	<b>15%</b>		<b>0.1</b>		<b>0.6</b>		<b>0.4</b>		<b>0.5</b>
<b>Additional Considerations</b>									
Noise and Impact on Neighbourhood	1%	4	0.04	3	0.03	1	0.01	2	0.02
Ability to re-open runway in Emergency	3%	0	0	4	0.12	3	0.09	3	0.09
Sustainability of Process	1%	1	0.01	2	0.02	4	0.04	4	0.04
<b>ADDITIONAL CONSIDERATIONS SUBTOTAL</b>	<b>5%</b>		<b>0.05</b>		<b>0.17</b>		<b>0.14</b>		<b>0.15</b>
<b>TOTAL</b>	<b>100%</b>		<b>1.77</b>		<b>3.3</b>		<b>2.58</b>		<b>2.66</b>

#### **4.11 Sensitivity of Criteria Selection and Impact of Criteria Weights and Scores**

The advantage of using the AHP tool is that the decision can include non-monetary factors such as environmental impact and promoting sustainable factors. The AHP tool is a numerical process that creates more objectivity in evaluating and accounting for non-monetary or social factors.

Additionally, the tool provides the opportunity for the impact of long term costs to be accounted for and included in the decision making process. In summary, using an AHP to make decisions is an alternative method for decision making than just considering the option with the lowest capital cost.

For this research, criteria for selecting the best runway rubber removal method are divided into five categories: cost, accessibility, pavement, environmental, and additional considerations. The following section describes the rationale behind the criteria selection. A sensitivity analysis using four case studies is provided to illustrate the effect of category weights and scores on the overall evaluation of rubber removal techniques. The case studies represent three commercial airports categorized by annual traffic and percent heavy aircrafts: a high volume airport (Table 4.7), an intermediate volume airport (Table 4.8), and low volume airport (Table 4.9). In addition, a case study for applying the AHP tool to a military airport is provided (Table 4.10).

Cost is a very tangible measurement, as the airport can obtain price quotes from contractors and suppliers to determine the start-up cost, cost of operation, and the equipment cost. By analyzing the revenues associated with landings and takeoffs, as well as the cost incurred with delays and backlog in the airport system, the airport can establish an hourly cost for runway closure.

In a high volume airport, the cost associated with runway closures may be a more critical factor than the start-up cost associated with rubber removal (Table 4.7). A high volume airport generates enough revenue to purchase rubber removal equipment, however the loss of revenue associated with additional runway closure is a significant factor. In a high volume airport, runway closure costs are likely much greater than the additional cost incurred with a high start-up cost. As such, the high volume airport would weigh start-up cost lower than lost revenue for runway closure (Table 4.7). In comparison, a low volume airport may not generate the revenue required to purchase equipment. However, the cost associated with a runway closure at a low volume airport may not be as critical as for a large volume airport (Table 4.9).

The next category in the AHP tool is accessibility. This category accounts for the difficulty of the technique, the availability of skilled workers and the availability of equipment and materials required for rubber removal. A military airport may not have a dedicated runway maintenance staff or staff with specialized experience in runway rubber removal. As such, the technique selected must be fairly simple for the military staff to learn. The military airport would assign a high weight to the Ease to Learn Cleaning Technique category (Table 4.10). A small airport may not have the required staff available for a person-hour intensive technique; as such they may assign a high weight the Availability of Skilled Workers category, and low scores to alternatives that require the involvement of several workers (Table 4.9).

Pavement is the third category of the AHP Decision Making Tool. This category accounts for damage done to the pavement by the rubber removal technique, texture of the pavement after cleanup,

and additional work required to return the pavement to an adequate level of service (LOS). Shotblasting and Mechanical removal remove a portion of the surface layer of the pavement. As such, the airport will have to account for this loss in structural thickness in the original pavement design and construction. Rubber accumulation is one of several factors that will decrease the runway friction. A large airport with a high volume of heavy aircraft traffic may require periodical retexturization of the runway. This corrects the loss of friction caused by polishing of the surface aggregate and wearing of the surface texture. Shotblasting is a treatment for the decrease in surface friction and has the added benefit of rubber removal. Economies of scale enable the large airport to budget for a thicker layer of surface pavement during construction.

Additionally, a large airport will require frequent rubber removal. Pavement damage caused by rubber removal is amplified by the frequency of rubber removal. In contrast, surface pavement wear is less of an issue for an intermediate volume airport, since rubber will accumulate at a slower rate than at a large volume airport. Pavement damage is a lower priority in selecting the rubber removal technique at an intermediate airport (Table 4.8) because rubber removal will not be as frequent at an intermediate airport as at a large airport (Table 4.7).

The additional work required to bring the pavement to an adequate level of service includes pavement marking repainting, fixing, and reinstalling runway appurtenances, and sweeping or inspecting the runway prior to reopening for service. A military airport will rate this as a low priority (Table 4.10) because there are fewer pavement markings and appurtenances that must be maintained and reinstalled compared to commercial airports.

The fourth category of the AHP Tool is environmental impact. This category encompasses the social perception of the rubber removal technique applied at the airport, the environmental impact of the technique itself, and the level of difficulty associated with obtaining necessary permits for rubber removal operations. Social perception of environmental practices is important at all commercial airports. The operations of a large airport are often heavily scrutinized by the public. The practices of a small airport may directly affect the neighbours surrounding the airport. A military airport may not be under the same public scrutiny as commercial airports. Military airports are often remotely located and the details of their management and operations may be classified information. In addition, military airports may be intended to be in service for a few years, and will perform a full environmental remediation of the site when the airport or runway is decommissioned. The long-term impact of the rubber removal technique selected may be mitigated if the airport performs a site environmental remediation. Planning to perform an environmental remediation results in a lower weight assigned to the environmental category at a military airport (Table 4.10).

The final category of the AHP decision-making tool is for additional, airport specific concerns. This category is for the airport to identify and incorporate relevant concerns not included in the previous four categories. For example, the ability to evacuate rubber removal equipment on short notice and reopen the runway in an emergency situation is a priority for military airports (Table 4.10). The overall sustainability of the rubber removal practice is a high priority for large volume airports that accumulate rubber quickly (Table 4.7). The noise impact of rubber removal on the neighbours is a higher concern for small volume airports (Table 4.9), because airports may be located in close proximity to a residential area. An intermediate volume airport is concerned with the sustainability of



the rubber removal process (Table 4.8). Dedication to the environment may help attract new passengers and cargo shipping clients to intermediate volume airports.

#### 4.11.1 Case Study: Application of the AHP Tool to a High Volume Airport

Table 4.7 shows that the following factors should be prioritized at a high volume airport:

- Lost revenue for runway closure
- Long term damage to Pavement

The cost associated with runway closure means a significant loss of revenue for a high volume airport. The high volume airport would assign a high weight to the criteria for Lost Revenue for Runway Closure. Shotblasting receives the highest score, followed by mechanical, waterblasting, and then chemical removal. Shotblasting and mechanical receive higher scores because these treatments also retexturize the pavement, resulting in a reduced number of runway closures for the airport to correct surface wear.

**Table 4.7 - Application of AHP Decision Making Tool to a High Volume Airport**

<i>High Volume Airport</i>		<i>Chemical</i>		<i>Waterblasting</i>		<i>Shotblasting</i>		<i>Mechanical</i>	
<b>CRITERIA</b>	<b>Weight (0-100%)</b>	<b>Score (0-10)</b>	<b>Wtd. Score</b>	<b>Score (0-10)</b>	<b>Wtd. Score</b>	<b>Score (0-10)</b>	<b>Wtd. Score</b>	<b>Score (0-10)</b>	<b>Wtd. Score</b>
<b>Cost</b>									
Start-up Cost	3%	1	0.03	3	0.09	2	0.06	4	0.12
Lost revenue for runway closure	30%	1	0.3	2	0.6	4	1.2	3	0.9
Cost of operation	10%	4	0.4	1	0.1	3	0.3	2	0.2
Equipment maintenance cost	2%	1	0.02	3	0.06	2	0.04	4	0.08
<b>COST SUBTOTAL</b>	<b>45%</b>		<b>0.75</b>		<b>0.85</b>		<b>1.6</b>		<b>1.3</b>
<b>Accessibility</b>									
Ease to learn cleaning technique	1%	4	0.04	3	0.03	2	0.02	1	0.01
Availability of skilled workers	1%	4	0.04	1	0.01	3	0.03	2	0.02
Availability of equipment and materials	2%	3	0.06	2	0.04	1	0.02	4	0.08
<b>ACCESSIBILITY SUBTOTAL</b>	<b>4%</b>		<b>0.14</b>		<b>0.08</b>		<b>0.07</b>		<b>0.11</b>
<b>Pavement</b>									
Damage to Pavement	15%	4	0.6	3	0.45	1	0.15	2	0.3
Texture of pavement after cleanup	10%	1	0.1	2	0.2	4	0.4	3	0.3
Additional work required for adequate LOS	5%	4	0.2	1	0.05	4	0.2	2	0.1
<b>PAVEMENT SUBTOTAL</b>	<b>30%</b>		<b>0.9</b>		<b>0.7</b>		<b>0.75</b>		<b>0.7</b>
<b>Environmental</b>									
Permits required	5%	0	0	4	0.2	4	0.2	4	0.2
Environmental damage	8%	1	0.08	4	0.32	2	0.16	3	0.24
<b>ENVIRONMENTAL SUBTOTAL</b>	<b>13%</b>		<b>0.08</b>		<b>0.52</b>		<b>0.36</b>		<b>0.44</b>
<b>Additional Considerations</b>									
Noise and Impact on Neighbourhood	2%	3	0.06	4	0.08	2	0.04	1	0.02
Ability to re-open runway in Emergency	1%	1	0.01	4	0.04	3	0.03	4	0.04
Sustainability of Process	5%	1	0.05	2	0.1	4	0.2	4	0.2
<b>ADDITIONAL CONSIDERATIONS SUBTOTAL</b>	<b>8%</b>		<b>0.12</b>		<b>0.22</b>		<b>0.27</b>		<b>0.26</b>
<b>TOTAL</b>	<b>100%</b>		<b>1.99</b>		<b>2.37</b>		<b>3.05</b>		<b>2.81</b>

The Long Term Damage to Pavement criteria also receives a high criteria weight for a high volume airport. Since chemical and waterblasting are minimally damaging to the pavement structure, these two alternatives receive a higher score than mechanical and shotblasting.

Using the criteria weights and scores assigned to the AHP tool in Table 4.7, the preferred rubber removal technique for a high volume airport is shotblasting. Mechanical removal is the second choice, waterblasting is the third choice, and chemical removal is the least preferred alternative.

#### 4.11.2 Case Study: Application of the AHP Tool to an Intermediate Volume Airport

Table 4.8 shows that the following factors should be prioritized at an intermediate volume airport:

- Cost of operation
- Availability of skilled workers

**Table 4.8 - Application of the AHP Decision Making Tool to an Intermediate Volume Airport**

<i>Intermediate Volume Airport</i>		<i>Chemical</i>		<i>Waterblasting</i>		<i>Shotblasting</i>		<i>Mechanical</i>	
<b>CRITERIA</b>	<b>Weight (0-100%)</b>	<b>Score (0-10)</b>	<b>Wtd. Score</b>	<b>Score (0-10)</b>	<b>Wtd. Score</b>	<b>Score (0-10)</b>	<b>Wtd. Score</b>	<b>Score (0-10)</b>	<b>Wtd. Score</b>
<b>Cost</b>									
Start-up Cost	10%	3	0.3	4	0.4	2	0.2	1	0.1
Lost revenue for runway closure	5%	1	0.05	4	0.2	2	0.1	3	0.15
Cost of operation	20%	4	0.8	3	0.6	1	0.2	2	0.4
Equipment maintenance cost	5%	4	0.2	3	0.15	4	0.2	1	0.05
<b>COST SUBTOTAL</b>	<b>40%</b>		<b>1.35</b>		<b>1.35</b>		<b>0.7</b>		<b>0.7</b>
<b>Accessibility</b>									
Ease to learn cleaning technique	5%	4	0.2	3	0.15	2	0.1	1	0.05
Availability of skilled workers	15%	2	0.3	4	0.6	1	0.15	3	0.45
Availability of equipment and materials	5%	2	0.1	3	0.15	1	0.05	4	0.2
<b>ACCESSIBILITY SUBTOTAL</b>	<b>25%</b>		<b>0.6</b>		<b>0.9</b>		<b>0.3</b>		<b>0.7</b>
<b>Pavement</b>									
Damage to Pavement	5%	4	0.2	3	0.15	1	0.05	2	0.1
Texture of pavement after cleanup	5%	3	0.15	3	0.15	4	0.2	1	
Additional work required for adequate LOS	5%	4	0.2	1	0.05	1	0.05	1	0.05
<b>PAVEMENT SUBTOTAL</b>	<b>15%</b>		<b>0.55</b>		<b>0.35</b>		<b>0.3</b>		<b>0.15</b>
<b>Environmental</b>									
Permits required	n/a								
Environmental damage	10%	4	0.4	3	0.3	2	0.2	1	0.1
<b>ENVIRONMENTAL SUBTOTAL</b>	<b>10%</b>		<b>0.4</b>		<b>0.3</b>		<b>0.2</b>		<b>0.1</b>
<b>Additional Considerations</b>									
Noise and Impact on Neighbourhood	5%	4	0.2	1	0.05	3	0.15	2	0.1
Ability to re-open runway in Emergency	n/a								
Sustainability of Process	5%	2	0.1	3	0.15	4	0.2	1	0.05
<b>ADDITIONAL CONSIDERATIONS SUBTOTAL</b>	<b>10%</b>		<b>0.3</b>		<b>0.2</b>		<b>0.35</b>		<b>0.15</b>
<b>TOTAL</b>	<b>100%</b>		<b>3.2</b>		<b>3.1</b>		<b>1.85</b>		<b>1.8</b>

In assigning scores for the Cost of Operation criteria, the highest scores for an intermediate volume airport are assigned to chemical and waterblasting, the lowest scores are assigned to mechanical and shotblasting. The availability of skilled workers is another high weight criterion, intermediate volume airport maintenance staff is likely not specialized in runway rubber removal. As such, waterblasting and mechanical removal receive high scores, and shotblasting and chemical removal receive low scores.

An intermediate volume airport likely does not require the ability to reopen the runway in emergency situation or require permits to perform runway maintenance. As such, these categories are not assigned a weight or score.

Overall, the preferred alternative for rubber removal in an intermediate volume airport is chemical treatment, with waterblasting being a close second choice. Shotblasting and mechanical removal received much lower weighted scores than chemical and waterblasting.

#### **4.11.3 Case Study: Application of the AHP Tool to a Low Volume Airport**

Table 4.9 shows that the following factors should be prioritized in a low volume airport:

- Start-up cost
- Cost of operation
- Availability of skilled workers
- Availability of equipment and materials

A small volume airport may not have the capital available to purchase dedicated equipment for rubber removal. Unlike a large volume airport, a small volume airport may only require rubber removal treatments annually or once every few years. A small volume airport assigns a higher score to the alternative with low start-up costs, and lower scores to alternatives with high start-up costs. A small volume airport likely owns brooms and runway clearing equipment that are suitable for mechanical rubber removal. Therefore, the small volume airport assigns the highest score to mechanical removal and the lower scores to shotblasting and waterblasting, since these two techniques require specialized equipment.

Cost of Operation includes the cost of either hiring an external contractor or the additional labour associated with completing rubber removal. This cost may be a restricting factor for a small volume airport. The small volume airport likely prefers waterblasting, which is not labour intensive. The small volume airport would rate the alternatives in the cost of operation category: waterblasting, mechanical, shotblasting and finally chemical.

Similarly, the availability of skilled workers relates to the number of workers that would be qualified or easily able to perform the rubber removal operation. A small volume airport likely rates mechanical with the highest score since staff would already be familiar with operating maintenance equipment.

**Table 4.9 - Application of the AHP Decision Making Tool to a Low Volume Airport**

<i>Low Volume Airport</i>		<i>Chemical</i>		<i>Waterblasting</i>		<i>Shotblasting</i>		<i>Mechanical</i>	
<b>CRITERIA</b>	<b>WEIGHT (0-100%)</b>	<b>Score (0-10)</b>	<b>Wtd. Score</b>	<b>Score (0-10)</b>	<b>Wtd. Score</b>	<b>Score (0-10)</b>	<b>Wtd. Score</b>	<b>Score (0-10)</b>	<b>Wtd. Score</b>
<b>Cost</b>									
Start-up Cost	15%	3	0.45	2	0.3	1	0.15	4	0.6
Lost revenue for runway closure	n/a								
Cost of operation	15%	1	0.15	4	0.6	2	0.3	3	0.45
Equipment maintenance cost	n/a								
<b>COST SUBTOTAL</b>	<b>30%</b>		<b>0.6</b>		<b>0.9</b>		<b>0.45</b>		<b>1.05</b>
<b>Accessibility</b>									
Ease to learn cleaning technique	10%	4	0.4	2	0.2	1	0.1	3	0.3
Availability of skilled workers	15%	3	0.45	1	0.15	2	0.3	4	0.6
Availability of equipment and materials	15%	2	0.3	3	0.45	1	0.15	4	0.6
<b>ACCESSIBILITY SUBTOTAL</b>	<b>40%</b>		<b>1.15</b>		<b>0.8</b>		<b>0.55</b>		<b>1.5</b>
<b>Pavement</b>									
Damage to Pavement	5%	3	0.15	4	0.2	1	0.05	2	0.1
Texture of pavement after cleanup	5%	3	0.15	4	0.2	2	0.1	1	
Additional work required for adequate LOS	5%	4	0.2	3	0.15	1	0.05	2	0.1
<b>PAVEMENT SUBTOTAL</b>	<b>15%</b>		<b>0.5</b>		<b>0.55</b>		<b>0.2</b>		<b>0.2</b>
<b>Environmental</b>									
Permits required	n/a								
Environmental damage	5%	1	0.05	3	0.15	2	0.1	4	0.2
<b>ENVIRONMENTAL SUBTOTAL</b>	<b>5%</b>		<b>0.05</b>		<b>0.15</b>		<b>0.1</b>		<b>0.2</b>
<b>Additional Considerations</b>									
Noise and Impact on Neighbourhood	10%	4	0.4	2	0.2	1	0.1	3	0.3
Ability to re-open runway in Emergency	n/a								
Sustainability of Process	n/a								
<b>ADDITIONAL CONSIDERATIONS SUBTOTAL</b>	<b>10%</b>		<b>0.4</b>		<b>0.2</b>		<b>0.1</b>		<b>0.3</b>
<b>TOTAL</b>	<b>100%</b>		<b>2.7</b>		<b>2.6</b>		<b>1.4</b>		<b>3.25</b>

Small volume airports may be located in remote communities where specialized equipment such as shotblasting machinery is not readily available. The airport then prioritizes rankings for equipment availability based on the tools that can be easily and economically accessed by the airport. In this example, mechanical is the most readily available tool, followed by waterblasting, chemical removal and shotblasting.

Criteria that may be irrelevant to a small airport are lost revenue associated with runway closure, the ability to reopen the runway in an emergency, the sustainability of the process, and requiring permits.

Overall, the preferred rubber removal technique for the small volume airport is mechanical removal, with chemical and waterblasting being second and third respectively, and shotblasting being the least preferred alternative.

#### 4.11.4 Case Study: Application of the AHP Tool to a Military Airport

Table 4.10 shows that the following factors should be prioritized in a military airport:

- Ability to reopen in an emergency
- Start-up cost

**Table 4.10 - Application of the AHP Decision Making Tool to a Military Airport**

<i>Military Airport</i>		<i>Chemical</i>		<i>Waterblasting</i>		<i>Shotblasting</i>		<i>Mechanical</i>	
<b>CRITERIA</b>	<b>Weight (0-100%)</b>	<b>Score (0-10)</b>	<b>Wtd. Score</b>	<b>Score (0-10)</b>	<b>Wtd. Score</b>	<b>Score (0-10)</b>	<b>Wtd. Score</b>	<b>Score (0-10)</b>	<b>Wtd. Score</b>
<b>Cost</b>									
Start-up Cost	15%	1	0.15	4	0.6	2	0.3	3	0.45
Lost revenue for runway closure	5%	1	0.05	4	0.2	2	0.1	3	0.15
Cost of operation	3%	4	0.12	3	0.09	1	0.03	2	0.06
Equipment maintenance cost	10%	1	0.1	3	0.3	2	0.2	4	0.4
<b>COST SUBTOTAL</b>	<b>33%</b>		<b>0.42</b>		<b>1.19</b>		<b>0.63</b>		<b>1.06</b>
<b>Accessibility</b>									
Ease to learn cleaning technique	5%	1	0.05	4	0.2	2	0.1	3	0.15
Availability of skilled workers	10%	4	0.4	1	0.1	3	0.3	2	0.2
Availability of equipment and materials	5%	3	0.15	2	0.1	1	0.05	4	0.2
<b>ACCESSIBILITY SUBTOTAL</b>	<b>20%</b>		<b>0.6</b>		<b>0.4</b>		<b>0.45</b>		<b>0.55</b>
<b>Pavement</b>									
Damage to Pavement	5%	3	0.15	4	0.2	2	0.1	1	0.05
Texture of pavement after cleanup	5%	1	0.05	3	0.15	4	0.2	2	0.1
Additional work required for adequate LOS	2%	1	0.02	3	0.06	4	0.08	2	0.04
<b>PAVEMENT SUBTOTAL</b>	<b>12%</b>		<b>0.22</b>		<b>0.41</b>		<b>0.38</b>		<b>0.19</b>
<b>Environmental</b>									
Permits required	n/a								
Environmental damage	5%	1	0.05	4	0.2	2	0.1	3	0.15
<b>ENVIRONMENTAL SUBTOTAL</b>	<b>5%</b>		<b>0.05</b>		<b>0.2</b>		<b>0.1</b>		<b>0.15</b>
<b>Additional Considerations</b>									
Noise and Impact on Neighbourhood	2%	4	0.08	3	0.06	1	0.02	2	0.04
Ability to re-open runway in Emergency	25%	1	0.25	4	1	3	0.75	4	1
Sustainability of Process	3%	1	0.03	2	0.06	4	0.12	4	0.12
<b>ADDITIONAL CONSIDERATIONS SUBTOTAL</b>	<b>30%</b>		<b>0.36</b>		<b>1.12</b>		<b>0.89</b>		<b>1.16</b>
<b>TOTAL</b>	<b>100%</b>		<b>1.65</b>		<b>3.32</b>		<b>2.45</b>		<b>3.11</b>

A military airport requires the ability to reopen a runway on short notice, so this category receives a high weight. Chemical removal has the lowest score, because a runway cannot be opened on short notice if detergent is on the runway. Waterblasting and mechanical removal receive high scores because this equipment can be removed from the runway quickly if needed. Shotblasting equipment can be removed from the runway fairly quickly, however an inspection for FOD is necessary before the runway is clear for reopening.

Permits are not an issue for military airports, and are not included in the decision making process. Overall, the preferred alternative for a military airport is waterblasting, with mechanical, shotblasting and finally chemical removal as the least preferred alternative.

#### 4.11.5 Summary of Case Studies

The four case studies for a high volume airport, intermediate volume airport, low volume airport, and military airport illustrate the sensitivity of changing criteria weight and scores in selecting the rubber removal technique. Table 4.11 is a summary of the scores calculated by the AHP Tool in the four case studies. The best alternative for the large volume airport is shotblasting, followed by mechanical, waterblasting, and finally chemical removal. The best alternative for the intermediate volume airport is chemical removal, followed closely by waterblasting. The best alternative for the low volume airport is mechanical removal, chemical and waterblasting are secondary choices, and shotblasting is the least preferred alternative. The best alternative for a military airport is waterblasting, followed by mechanical, shotblasting, and chemical removal.

**Table 4.11 - Summary of Scores for Rubber Removal Techniques**

<b>Classification</b>	<b>Chemical</b>	<b>Waterblasting</b>	<b>Shotblasting</b>	<b>Mechanical</b>
Large Volume	1.99	2.37	<b>3.05</b>	2.81
Intermediate Volume	<b>3.2</b>	3.1	1.85	1.8
Low Volume	2.7	2.6	1.4	<b>3.25</b>
Military	1.65	<b>3.32</b>	2.45	3.11

#### 4.12 Chapter Summary

Rubber accumulation is an issue on airport runways as it decreases the overall friction properties of the runway. Friction should be tested more frequently for airports with high volume of landings or high percentage of heavy aircrafts landing on the runway. Friction should also be tested from both ends of the runway.

Rubber accumulation is caused by the force, speed and heat generated when an aircraft lands; the rate of rubber accumulation depends on the volume and type of traffic at an airport. Adequate runway friction is important for safely stopping an aircraft. In warm, bare and dry conditions, rubber accumulation may help improve friction between rubber on the runway and rubber in the aircraft tires. However, wet rubber or rubber with a contaminant on its surface becomes very slick, reducing the friction properties of the pavement. Rubber accumulation also blocks drainage channels created by pavement macrotexture, reduces the coarseness of the pavement microtexture, further reducing the overall pavement friction. As a result, rubber accumulation may make it more difficult to stop an aircraft, or to maintain directional control of an aircraft during landing.

This chapter presented four of the most commonly used methods for removing rubber from a runway. Chemical removal involves using a detergent that is allowed to permeate and soften runway rubber before being rinsed off the runway. Waterblasting uses high pressure streams of water to blast rubber deposits off the runway. Shotblasting involves high velocity metal balls being shot on the pavement surface to remove rubber and retexture the pavement. Mechanical rubber removal includes sandblasting, broom removal and scraping rubber from the runway. Chemical and waterblasting are more commonly used for rubber removal. Shotblasting and mechanical removal are more frequently used when the primary goal is to improve the pavement macrotexture and microtexture through retexturization; rubber removal is a secondary benefit of these techniques.

This chapter also included an AHP decision making tool that can be used by pavement managers to select the most appropriate rubber removal technique for their airport. This decision making tool can be incorporated into the airport's pavement management system and used to evaluate rubber removal needs.

#### **4.12.1 Chapter Key Points**

An APMS can be used to:

- Monitor the rate of rubber accumulation and identify the areas that are most likely to accumulate rubber.
- Track runway friction over time, including changes to runway friction caused by rubber accumulation and improvement to friction caused by rubber removal.
- Determine the frequency of friction testing required for each runway.
- Select the best rubber removal technique to meet the airport's needs, both in terms of pavement performance and budget optimization.

## **Chapter 5**

### **Improving Runway Condition Assessment and Reporting**

This chapter discusses current runway condition assessment and reporting and provides recommendations for improvements.

#### **5.1 Analysis of Runway Surface Condition Reports**

Runway surface condition (RSC) reports were collected and analyzed from the Region of Waterloo International Airport from mid November 2010 to the end of March 2012. The RSC reports describe the condition of the runway surface at the time of reporting; the information contained within the RSC reports is provided to pilots to inform them of the ground conditions prior to landing. Upon reviewing the RSCs collected by the Waterloo International Airport, several suggestions for improving the current state of practice for measuring and reporting runway conditions became evident and are described in this chapter.

##### **5.1.1 Issue: Canadian Runway Friction Index Reporting Frequency**

Current CRFI measurements, when provided, are given for the entire runway [Waterloo, 2012]. This measurement could instead be divided into one third sections whereby the first-third of the runway, second-third of the runway and third-third of the runway are reported separately. It is customary to report friction measurements in one-third increments of the runway, so that the pilot has a sense of the friction for each part of the runway and the associated changes in friction throughout the runway. The CRFI testing equipment at the Region of Waterloo Airport collects several spot friction tests throughout the runway length, and then provides an overall friction measurement for the runway. This single CRFI number is then reported in RSC reports and Notice to Airmen (NOTAM) the airport produces.

The CRFI procedure involves reporting one CRFI number describing the overall condition of the entire runway. Pilots are given a CRFI number, and can use the CRFI number in combination with CRFI tables and their expected landing requirements for bare and dry conditions to estimate their landing conditions given the CRFI information they have been provided. It is important for Pilots to be able to assess the runway as a whole; however, it may be useful for pilots to be supplied with friction or braking availability readings for one-third segments of the runway to have a better sense of the areas of the runway where friction is critical.

##### **5.1.2 Issue: Discrepancy between CRFI Test Time and Reporting**

In reviewing the RSC reports as a part of this research, it became evident that the CRFI tests were not being reported as they were being collected [Waterloo, 2012]. There were instances when a CRFI test was collected but the results were not published until the RSC report had been completed. The current process for reporting a CRFI test is to first measure the CRFI at the airport, report the CRFI to NavCanada, and then NavCanada posts the CRFI for pilots.

However, it would be recommended that the airport air traffic control (ATC) is able to have immediate access to the CRFI test results as soon as the test is completed. Additionally, given recent technology advances in automating communication, it would be suggested that CRFI results are



published in real time, directly from the CRFI testing machine's console to an online media that pilots could access in real time.

### **5.1.3 Issue: Runway Cleared during Data Collection for the RSC Report**

There were several cases where the operator completing the RSC report noted that the runway was currently being cleared (presumably from winter contaminants), at the same time as the data was being collected for the RSC [Waterloo, 2012]. While this does inform pilots that the present runway contaminants are being removed, it does not provide pilots with an accurate indication of what the conditions will be when they land the aircraft. The runway condition report may indicate snow is present on the runway, and the snow could be over ice that would be observed if the RSC survey is completed after the snow removal.

To provide pilots with more current information and a better understanding of the runway conditions following snow removal, a RSC survey should be conducted immediately following snow clearing operations. If applicable, a CRFI test should be conducted to determine the runway friction immediately following snow and winter contaminant removal.

### **5.1.4 Issue: CRFI Data not collected when environmental conditions merit CRFI Tests**

When ice is present on the runway, a CRFI measurement is required [TC, 2012a]. Upon reviewing the RSCs collected from the Waterloo Airport between November 2010 and March 2012, it became evident that on several occasions, CRFI was not measured and reported in an RSC Report that indicated ice was present on the runway [Waterloo, 2012]. While publishing RSC Reports that inform pilots of icy runway conditions does give pilots information about what to expect when landing, the subjective description of ice present on the runway does not provide pilots with enough information. If this information were available, a CRFI number would be a valuable piece of information for calculating the required landing distance based on the CRFI tables.

Part of the challenge with collecting CRFI data at a small airport is that the airport may not have the staff available to run a CRFI test when environmental conditions merit a CRFI test, because the priority for staff is to clear the runway of contaminants. Since CRFI measurements provide meaningful information to pilots, collecting CRFI measurements should be an important and budgeted priority for airports. The staffing issue could be addressed by creation of an additional position, whereby someone is always available to collect the CRFI data. While this may mean an additional operational cost for the airport, the airport can seek federal funding or change the landing fee structure to account for the additional cost associated with this measurement.

### **5.1.5 Issue: RSC Reports do not provide Context regarding Environmental Conditions**

Runway Surface Condition Reports only provide information about the surface condition, but do not provide pilots with information about the environmental conditions at the airport at the time the RSC survey was collected [Waterloo, 2012]. While pilots receive reports about the weather and environmental conditions, it would make more sense if all the information came in one complete report for pilots to assess the conditions at the airport.

Weather information that could affect the rate contaminants accumulate at the airport should be included in the RSC report. These factors include, but are not limited to depth and type of precipitation; ambient and pavement temperature, wind speed and direction. A temperature change of a few degrees can drastically change the frictional properties of contaminants on the runway [Giesman, 2007]

#### **5.1.6 Issue: RSC Reports are only valid when the RSC survey is collected**

Another inherent problem with the RSC reports is that the report reflects the conditions at the time of the RSC survey, and as such, the report is only valid at the time the survey was collected. The RSC report does indicate the time the survey was collected, however, in many cases where the weather is changing, or when the runway is being cleared, the conditions reported in the RSC Report will be different than the conditions on the runway when the next aircraft lands [Waterloo, 2012].

Transport Canada does provide very clear guidelines indicating that RSC reports should be published as conditions change. In addition, a return to Bare and Dry conditions requires that a RSC Report must be published if any of the following conditions are met [TC, 2012a]:

1. A change in the coefficient of friction of 0.05 or more.
2. Changes in depth of deposit greater than 20 mm (0.79 in.) for dry snow, 10 mm (0.4 in.) for wet snow, 3 mm (0.13 in.) for slush.
3. A change in the cleared width of a runway of 10 percent or more.
4. Any change in the type of deposit or extent of coverage including a return to bare and dry conditions.
5. Any change in the height or distance from centre line of snow banks on one or both sides of the runway.
6. Any change in the visibility of runway lighting because the lights are obscured by contaminants.
7. Any other conditions that are, in the opinion of the aerodrome authority, considered to be significant.

The Region of Waterloo does provide frequent RSC reports, and is thorough in noting changes in weather conditions. However, even with the most vigilant reporting, the surface conditions during a winter storm may change from when the report was issued. During storms or weather events that may affect the RSC, the report filed should include a note warning pilots of anticipated changes in the surface condition based on weather forecasts and current storm conditions.

#### **5.1.7 Issue: Level of Detail in Data Collection Method**

The RSC reports are based on a visual inspection of the runway. At the Region of Waterloo Airport, the test is often conducted by an operator who drives a maintenance truck down the runway, and enters a visual observation of the surface conditions into the airport's TRACR program console [Waterloo, 2012]. The reports are subjective, and vary between operators.

In short, visual observations of the runway are still subjective. It would be suggested that technology that uses high resolution and high quality digital pictures be used to evaluate the runway. Furthermore, these real time photos could potentially be available to pilots to provide a visual of the

runway conditions that can be anticipated upon landing. If the airport installs stationary permanent cameras, or video cameras capable of taking still frames, a program could be introduced that captures real time images of the runway, and pilots can also observe changes in the runway conditions over time. If a permanent camera installation is not feasible, an operator could potentially take pictures while conducting their survey of the runway or a camera could simply be mounted on the truck and take photos. These pictures can be digitally stitched together to provide pilots approaching the runway a very good sense of what the runway looks like, prior to them landing. Pictures and video should not replace the current method of completing visual runway inspection; instead, pictures should supplement the current RSC report format to provide pilots with more information.

### 5.1.8 Issue: RSC reports do not Identify Contamination Location

The current format of RSC reports issued by the Region of Waterloo International Airport is to provide a percentage of the runway covered by a contaminant [Waterloo, 2012]. In general, the extent of contaminant coverage is reported in ten percent increments; between November 2010 and March 2012 only a handful of reports had contamination reported in 5% increments. With the current method of reporting contamination coverage as a percentage, there is no indication of where the contamination occurs on the runway, and whether the contamination is isolated in one area or spread randomly throughout the runway. For example, a RSC report may indicate a runway is “80% Bare and Dry, and 20 % Ice.” However, there is no location information in this statement whether the ice is at the touch down point, midway through the runway or at the end of the runway, or whether the ice is close to centreline, or near the left or right shoulder.

The solution of providing pictures of the runway would provide pilots with a better sense of where contaminants are located on the runway. Alternatively, the RSC could be supplemented with a computer drawn sketch of the location of runway contaminants. Figure 5.1 shows how a sketch identifying the location of RSC contaminants would provide pilots with a better sense of the location of contaminants. Figure 5.1 visually explains the distribution of contaminants along the runway, and provides more information to supplement a report that says “80% Bare and Dry, and 20 % Ice.” Standardized colours and geometric patterns could be used to indicate contaminant type, and the runway could be divided into thirds along the direction of travel, with centreline markings showing the left-right split of the runway.

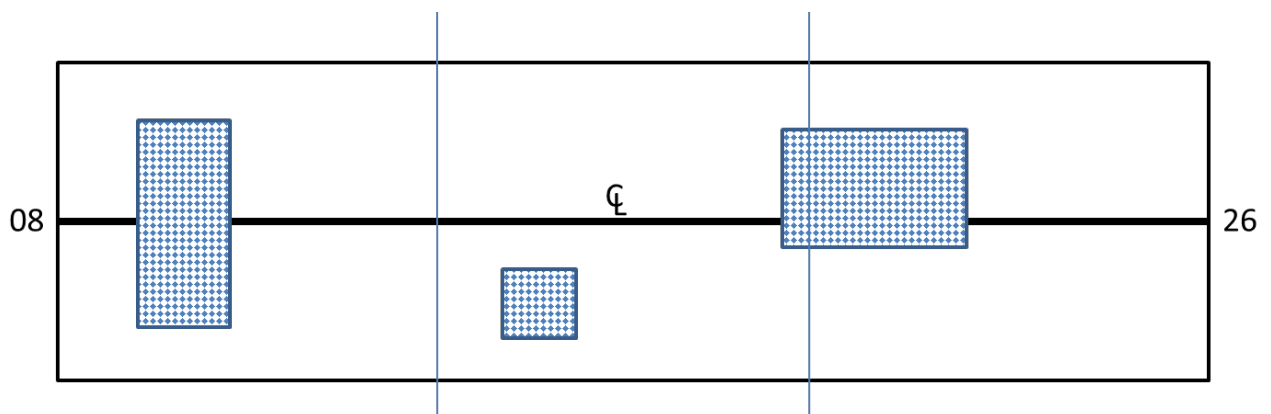

Figure 5.1 - Illustration identifying location of runway contaminants

### 5.1.9 Issue: Descriptions of Contaminants not Clearly Defined

The runway surface condition reports list a combination of conditions and possible contaminants present on the runway [Waterloo, 2012]. Typically, the runway is either: “Bare and Dry,” “Bare and Wet” or “Bare and Damp.” The RSC reports also indicate the presence of contaminants, such as snow, ice frost and slush. The conditions and range of depths (where applicable) used to describe the runway surface in the Region of Waterloo International Airport’s RSC reports from November 2010 to March 2012 summarized in Table 5.1.

**Table 5.1 – Summary of RSC Report Contaminant Descriptions and Reported Depths, Region of Waterloo International Airport November 2010- March 2012**

Condition	Minimum reported depth	Maximum reported depth
Bare and Dry	--	--
Bare and Wet	--	--
Bare and Damp	--	--
Dry snow	Trace	762 mm (30")
Frost	--	--
Ice	--	--
Slush	Trace	35 mm (1-3/8")
Snow Drifts	3 mm (1/8")	152 mm (6")
Wet Snow	Trace	305 mm (12")

The difficulty with the condition categories shown in Table 5.1 is that the distinction between the different descriptions is unclear. The difference between the description of wet and damp and the effect that a wet runway has versus a damp runway on the anticipated braking action of an aircraft is unclear.

Similarly, the differences between a trace amount of wet snow and a trace amount of slush or a trace amount of dry snow and a 3 mm snow drift are also unclear. Ice is not accompanied with a depth measurement, so it is unclear what the difference between ice and frost is, along with the different effects ice or frost will have on the braking action of the aircraft.

The categories used to describe runway surface conditions are the standard set by Transport Canada. However, since there is a minute difference between several of the phrases used to describe runway surface conditions, the choice of wording is at the discretion of the operator conducting the survey. One operator may favour describing the runway as icy, whereas another operator may describe the runway as having frost present.

To simplify RSC Reports, Transport Canada should investigate the impact of changing the current reporting structure to a more consolidated format, where more broad categories are used to describe the runway conditions. Frost and Ice could be amalgamated into one category, snow drifts and dry

snow could be combined and wet snow and slush could be combined. Alternatively, the categories could be changed to Bare, Ice, Snow and Loose Snow, as these descriptors are more in line with the contaminant categories provided in CRFI Tables.

#### **5.1.10 Issue: Measurement of Contaminant Depth**

The RSC reports from the Region of Waterloo International Airport showed a range of contaminant depths throughout the November 2010 to March 2012 period [Waterloo, 2012]. If a contaminant was present, only one depth measurement was provided along with the percentage of the runway covered, implying a uniform contaminant depth for the specified percentage of contaminated runway. It was also observed that the contaminant measurements were reported in very specific 3 mm (1/8") increments for contaminant depths under 51 mm (2") but then reported very generally for depths over 2". In general, contaminant depths over 2", were reported in 2" increments (2", 4", 6" etc.) up to 10", after 10" the depths were often reported in 10" increments (10", 20", 30" etc.). At the Waterloo Airport, the depths are often based on a visual estimate; the operator is not required to get out of their vehicle and measure contaminant depths, the operator will measure the depth of contaminant if it is not visually discernible.

It is important to precisely measure the contaminant depth so airport operators know when it is necessary to conduct CRFI or other friction tests. However, it would be more meaningful for the RSC to report the depth of contaminants fall within a range, such as: Depth >2", 2" < Depth < 5", 5" < Depth <10", 10" < Depth <20", Depth > 20" etc. Providing a range indicates the contaminant may vary in depth, and also accounts for observation error in visually gauging the depth of the contaminant.

#### **5.1.11 Issue: Aviation Industry needs better Instrumentation and Measuring Tools**

Horizontal and vertical wind shear (characteristic of thunderstorms) creates significant hazards for the takeoff, approach and landing of an aircraft; currently Canadian aerodromes are not equipped with ground based instruments capable of measuring wind shear [TC, 2012c]. Figure 5.2 and Figure 5.3 show the effect wind shear can have on an aircraft during landing.

Given the lack of wind shear detecting equipment, Transport Canada reports that the most meaningful method of tracking wind shear is from information supplied through pilot reports. Transport Canada provides the following guidelines for reporting wind shear:

“Since ground-based instruments to measure wind shear have not been installed at Canadian aerodromes, the presence of such conditions can normally be deduced only from PIREPs.

Aircrew capable of reporting the wind and altitude, both above and below the shear layer, from Flight Management Systems (FMS) are requested to do so. Pilots without this equipment should report wind shear by stating the loss or gain of airspeed and the altitude at which it was encountered. Pilots not able to report wind shear in these specific terms should do so in terms of its general effect on the aircraft.” [TC, 2012c]

This statement highlights several important issues:

1. Canadian aerodromes are not equipped with measuring instrumentation capable of measuring wind shear from the ground.
2. It is not expected that all aircrafts flying through Canadian aerodromes are equipped with a FMS capable of measuring wind shear.
3. It is not expected that all Pilots are able to report wind shear in terms of loss or gain of airspeed and altitude.

To improve the state of the industry, Canadian aerodromes need to be equipped with tools capable of measuring wind shear. Wind shear can be detected using low level wind shear alert systems or terminal Doppler wind shear radar [NASA, 2008].

Aircrafts need to be equipped with tools that can provide predictive warnings for wind shear. In 1988, the FAA mandated that all commercial airlines be equipped with onboard wind shear detection systems [NASA, 2008]. Optional predictive wind shear warning systems and reactive warning systems are available on most aircrafts, and provide warning depending on the aircraft's angular position, altitude and flight phase [Airbus, 2007].

Perhaps most important is improving pilot training, ensuring that pilots are prepared to adjust an aircraft landing through a wind shear zone. Inability to accommodate for wind shear may result the aircraft crashing when attempting to land. It is also important that pilots capable of clearly and consistently reporting any encounters with wind shear in a Pilot Report.

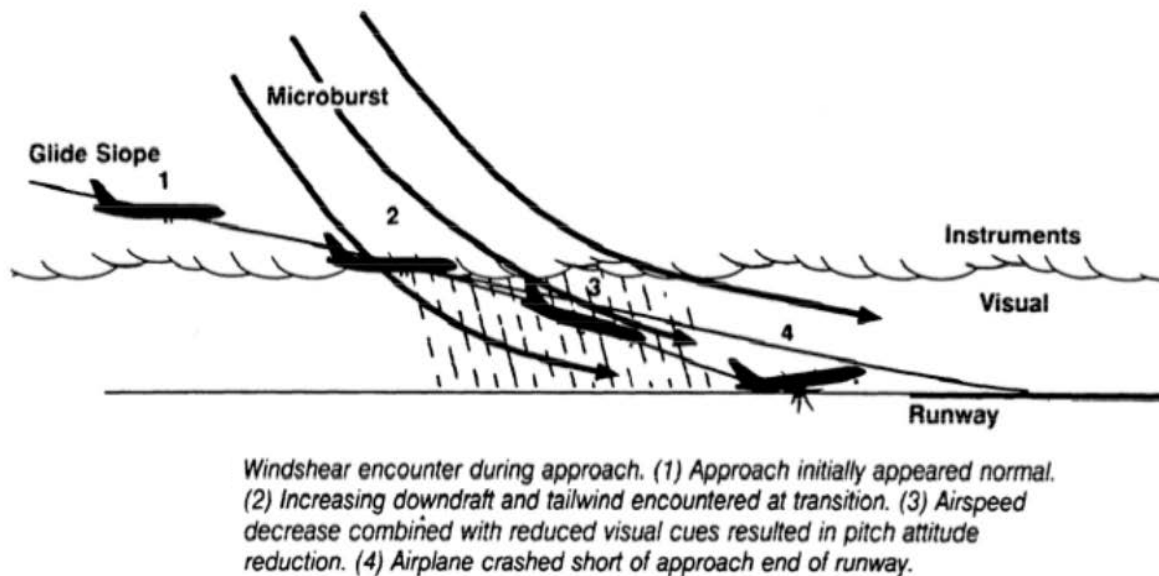

**Figure 5.2 - Illustration of Impact of Wind Shear on Landing [Touring, 2008]**

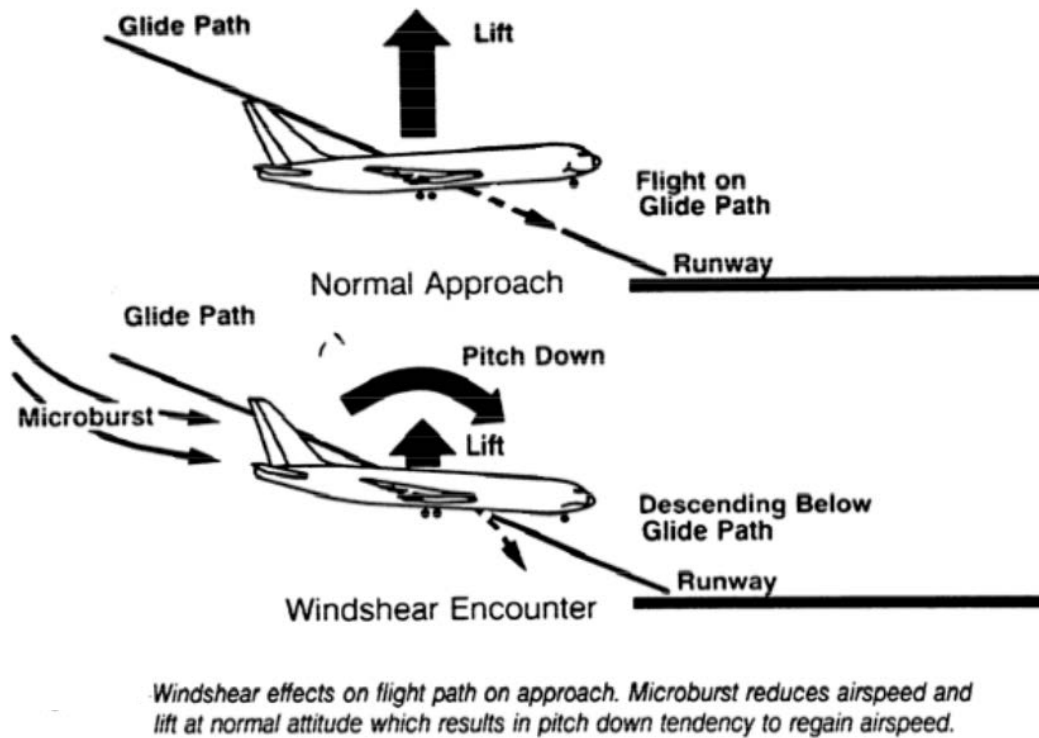

**Figure 5.3 – Comparison of Normal and Wind shear Landing [Touring, 2008]**

#### **5.1.12 Issue: Pilot Reports are Subjective**

One of the biggest issues with Pilot Reports is that there is an inherent amount of subjectivity in reporting, especially when describing cloud layers, weather, turbulence, airframe icing and providing remarks. Factors such as pilot experience and familiarity with the flight route may influence the pilot’s description of extreme and ordinary weather conditions. Additionally, pilot experience may lead to more accurate interpretation, estimation and expression of weather conditions that cannot be measured using inflight equipment. Transport Canada acknowledges that variables such as wind speed and direction may be based on pilot estimation and suggests pilots note when an estimate is provided in the pilot report.

When it comes to braking action and braking availability, pilots are able to learn the conditions perceived by previous pilots landing at the airport through pilot reports. The information contained in PIREPs is subject to the reporting crew’s experience and the equipment they have available on the flight deck. Landing evaluation can be affected by the aircraft size, weight, approach speed, amount of wheel braking applied, highest level of braking used; a pilot of a small and light aircraft may perceive conditions differently than the pilot of a large aircraft, even when landing moments apart on the same runway [Giesman, 2007].

## 5.2 Chapter Summary

Runway surface condition reports are prepared by airport operators to describe the conditions present on an airport runway. The information contained in RSC reports is used to prepare pilots for landing and provide the information necessary to calculate landing distances. This chapter identified several areas for runway surface condition reports.

Major issues in current practice are subjectivity in data collection and evaluation of runway conditions. Removing subjectivity in measurement can be accomplished by streamlining the reporting procedure and using pictures, drawings and specific descriptions of contaminant type and location on the runway. In addition, Canadian airports should move towards using advances in technology to provide real time, current information to pilots prior to landing.

### 5.2.1 Chapter Key Points

Runway surface condition reports can be improved by:

- Providing friction measurements that are divided into one third sections of the runway.
- Reporting CRFI in real time, directly from the test vehicle console.
- Conducting RSC surveys immediately following snow clearing operations.
- Prioritizing performing RSC surveys by increasing staff during inclement weather.
- Including local weather information to provide aviators context regarding anticipated runway conditions.
- Vigilance in reporting changes to runway conditions.
- Supplementing the RSC report with pictures of the runway taken during RSC inspection.
- Identifying contaminants by type and location either with pictures or a runway sketch.
- Clearly defining contaminants and distinguishing the different effect each contaminant will have on braking performance.
- Reporting the depth of contaminant falls within a specific range.
- Reducing Canadian aerodrome dependence on PIREPs by installing measuring equipment that detects and report wind shear.
- Reformatting PIREPs to reduce or eliminate subjectivity.



## Chapter 6

### Braking Availability Tester

#### 6.1 Design of the Braking Availability Tester

The Braking Availability Tester (BAT) is being developed as a part of this research in partnership with Team Eagle Ltd., the Ontario Centres of Excellence and the University of Waterloo Centre for Pavement and Transportation Technology. It also involves researchers and one Masters graduate student from the Mechanical and Mechatronics Engineering Department at the University of Waterloo. The objective of this device is to provide the aviation industry with more real time information about runway conditions, especially in the presence of winter contaminants. The intent of the BAT is to accurately predict the braking availability on a runway, and provide pilots with information critical for making landing and rejected take off decisions. The distinguishing feature of the BAT is that it simulates an actual aircraft by using a scaled aircraft Antiskid Braking System (ABS) algorithm applied to a hydraulically actuated aircraft tire and braking system. Figure 6.1 is a schematic illustration of the BAT. As noted in Figure 6.1, the BAT incorporates an aircraft tire and aircraft braking system that can be hydraulically raised and lowered to simulate an aircraft touchdown. The BAT system also includes several sensors that measure vertical, lateral and torque load in addition to speed and pavement temperature. The following discussion provides an overview of the mechanical components of the device.

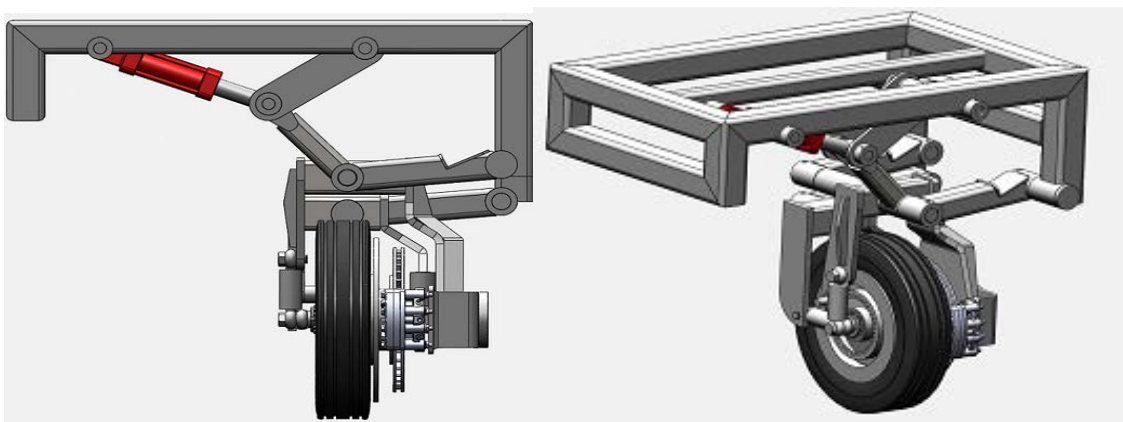

**Figure 6.1 - Schematic illustration of the BAT**

When an aircraft lands on a contaminated runway, slip often occurs during the braking phase. When the aircraft ABS detects slip, it cyclically engages and releases the brakes until slip no longer occurs or the aircraft stops. The cyclic braking action leads to increased landing distances, which may result in a runway overrun if the runway is not adequately long to account for the loss of friction anticipated when contaminants are present. By incorporating an ABS algorithm in the braking mechanism of the BAT wheel, the BAT is designed to account for the cyclic braking that aircraft tires experience when slip is detected.

## 6.2 Mechanical Design and Sensors Incorporated in the BAT

The BAT is being developed as an affordable and practical measuring device for airports to use to provide pilots with real time information that is both accurate and a realistic representation of the runway conditions. The testing mechanism of the prototype BAT is mounted on a commercially available Ford F-350 truck, with the testing mechanism and braking system being powered and controlled separately from the truck. Figure 6.2 shows the prototype Braking availability Tester. The BAT was designed in partnership by Team Eagle Ltd. and the Faculty of Engineering at the University of Waterloo Civil and Environmental Engineering Department and the Mechanical and Mechatronics Department, with advice from Sunsource Ltd and Arnie Beck. It has also been supported by the Ontario Centres of Excellence.



**Figure 6.2 - Prototype Braking Availability Tester**

### 6.2.1 Thermocouples

A thermocouple is a sensor that converts a voltage between two different metals into a temperature. The BAT has three thermocouples; the primary purpose of these thermocouples is to measure the temperature in specific areas of the BAT. The first thermocouple measures the ambient air temperature, while the second and third thermocouples measure the temperature on the left and right sides of the BAT wheel braking caliper. The BAT thermocouples are capable of measuring

temperatures ranging from  $-40^{\circ}\text{C}$  ( $-40^{\circ}\text{F}$ ) to  $300^{\circ}\text{C}$  ( $572^{\circ}\text{F}$ ). Figure 6.3 shows the placement of thermocouples in the Braking Availability Tester.



**Figure 6.3 - Configuration of Thermocouples in the BAT**

Measuring the ambient air temperature is useful for verifying the BAT trials are occurring according to the proposed test matrix. As such, this sensor is necessary for the prototype BAT; however, it may be redundant in future generations of the BAT since the primary purpose of this sensor is to verify testing conditions. The braking caliper temperature sensors are useful for ensuring the braking caliper does not over heat during repeated trials. The thermocouples measuring the temperature of the braking caliper should be included as a safety feature in future generations of the BAT. For safety reasons, the BAT is designed so that if the temperatures measured by the braking caliper thermocouples exceed a threshold value, the microprocessor will automatically shut the BAT down so the braking calipers can cool down.

### **6.2.2 Infrared Temperature Sensor**

The infrared temperature sensors also measure the temperature of the braking caliper. The infrared sensors are a secondary means of measuring the temperature as they are capable of measuring a larger range of temperatures. The infrared sensors installed on the BAT are capable of measuring temperatures ranging from  $-40^{\circ}\text{C}$  ( $-40^{\circ}\text{F}$ ) to  $500^{\circ}\text{C}$  ( $932^{\circ}\text{F}$ ). Similar to the aforementioned brake

caliper, if the temperature measured by the infrared sensors exceeds a threshold value, the BAT will automatically shut down for safety reasons.

### **6.2.3 Pavement Temperature Sensor**

The pavement temperature sensor is an infrared sensor mounted on the passenger side of the BAT that measures the temperature of the pavement. This sensor is used for the prototype BAT to verify the testing conditions satisfy the requirements outlined in the experimental set up. The data collected from the pavement sensor may be used to draw a correlation between the pavement temperature and the braking distance required for an aircraft to stop.

### **6.2.4 Hydraulic Cylinder and Pressure Sensors**

The Hydraulic Cylinder is the mechanical device that controls raising and lowering the BAT wheel, and the load applied to the BAT wheel. Lowering the BAT wheel simulates an aircraft landing; a touchdown occurs when the BAT wheel makes contact with the pavement.

By increasing the pressure of hydraulic fluid flowing through the cylinder, the hydraulic cylinder applies a vertical load to the BAT wheel, simulating the weight of a landing aircraft. Simulating the weight of a landing aircraft is one of the factors that make the BAT different from conventional friction testers used at airports. The load applied on the BAT tire can be mathematically scaled to closely represent the load applied to a wheel in the landing gear system of a landing aircraft. It is anticipated that being able to model this relationship will help provide a more accurate understanding of the braking action of a landing aircraft. Figure 6.4 shows the hydraulic cylinder and pressure sensors in the BAT.

The hydraulic cylinder is equipped with two bi-directional transducers, also known as pressure sensors. The pressure sensors on the hydraulic cylinder measure the pressure of hydraulic fluid as it flows through the cylinder. They are positioned at the top and bottom of the cylinder, and are capable of measuring pressure ranging from 0 MPa to 21 MPa (0 psi - 3000 psi). To lower the BAT wheel, hydraulic fluid must flow in the hydraulic line past the top transducer, and out of the hydraulic line past the bottom transducer, as this top-down direction of flow causes the hydraulic cylinder to exert force down, thus lowering the BAT wheel. Conversely to raise the BAT wheel, the hydraulic fluid must flow into the hydraulic line from the bottom transducer and out of the hydraulic line past the top transducer, as this direction of flow causes the hydraulic cylinder to decrease the load applied to the BAT wheel and retract the mechanism from the ground. The rate at which the hydraulic wheel is raised or lowered and the magnitude of the load being applied to the BAT wheel can be controlled by changing the pressure of the hydraulic fluid flowing through the hydraulic line in the cylinder.

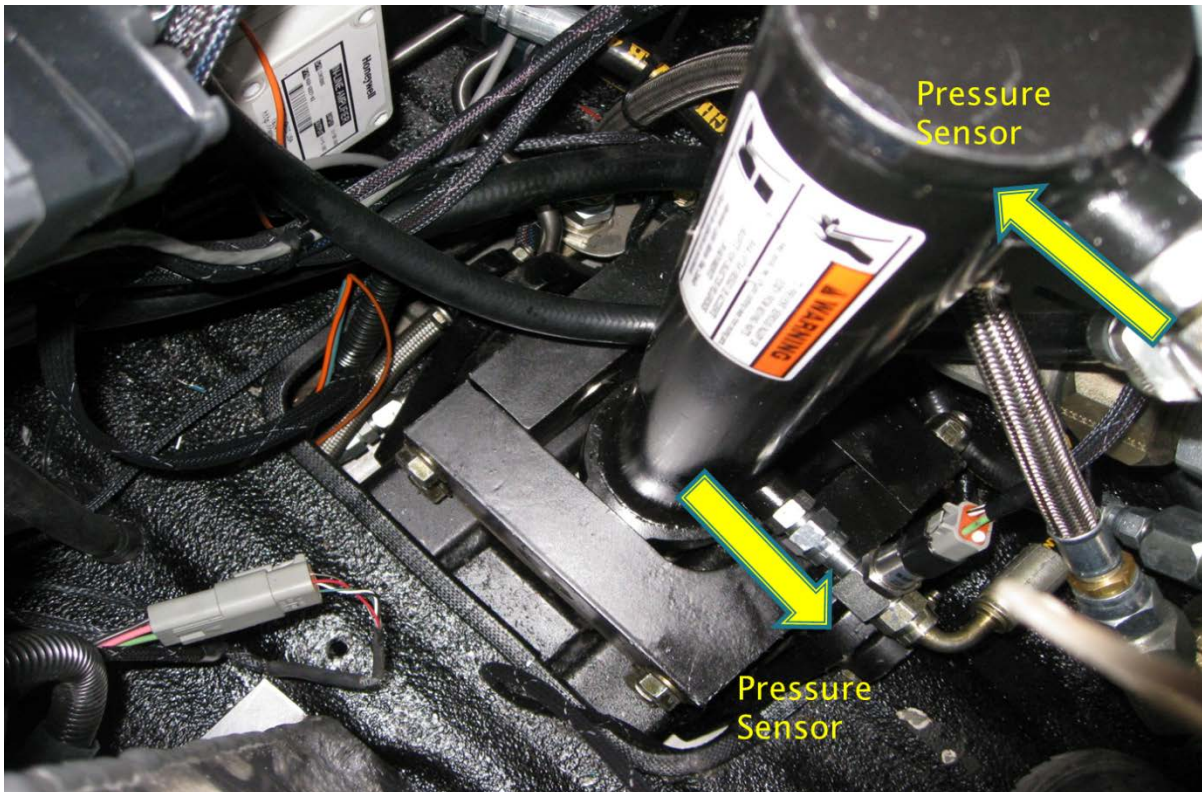

**Figure 6.4 – Hydraulic Cylinders and Pressure Sensors in the BAT**

The primary purpose of the pressure sensors is to provide the operator with information for lowering and raising the BAT wheel. By knowing the pressure flowing through the hydraulic line, the pressure sensors also provide the information required to determine the magnitude of vertical load being applied to the BAT tire in the touchdown position.

### **6.2.5 Load Cells**

The primary role of the load cells is measuring the force applied to the BAT wheel. The BAT is equipped with three load cells that are capable of measuring tension or compression forces. The first load cell measures the vertical force applied on the BAT wheel. The horizontal load cell measures the horizontal force being applied on the BAT wheel. The measured horizontal force will be used to calculate the drag force on the BAT wheel. The third and final load cell on the BAT wheel measures the torque force applied on the BAT wheel. The torque force obtained by this load sensor will be used to calculate the anti-slip forces on the BAT wheel. Figure 6.5 shows the load cell configuration in the BAT.

Calculating the normal force from the vertical load cell, the drag force from the horizontal load cell, and the anti-slip forces from the torque load cell provide the information required to determine the frictional coefficients and braking distance of the BAT wheel. By modifying the vertical load applied on the BAT wheel, the information measured by the load cells can be scaled and extrapolated to model the anticipated braking action of aircrafts.

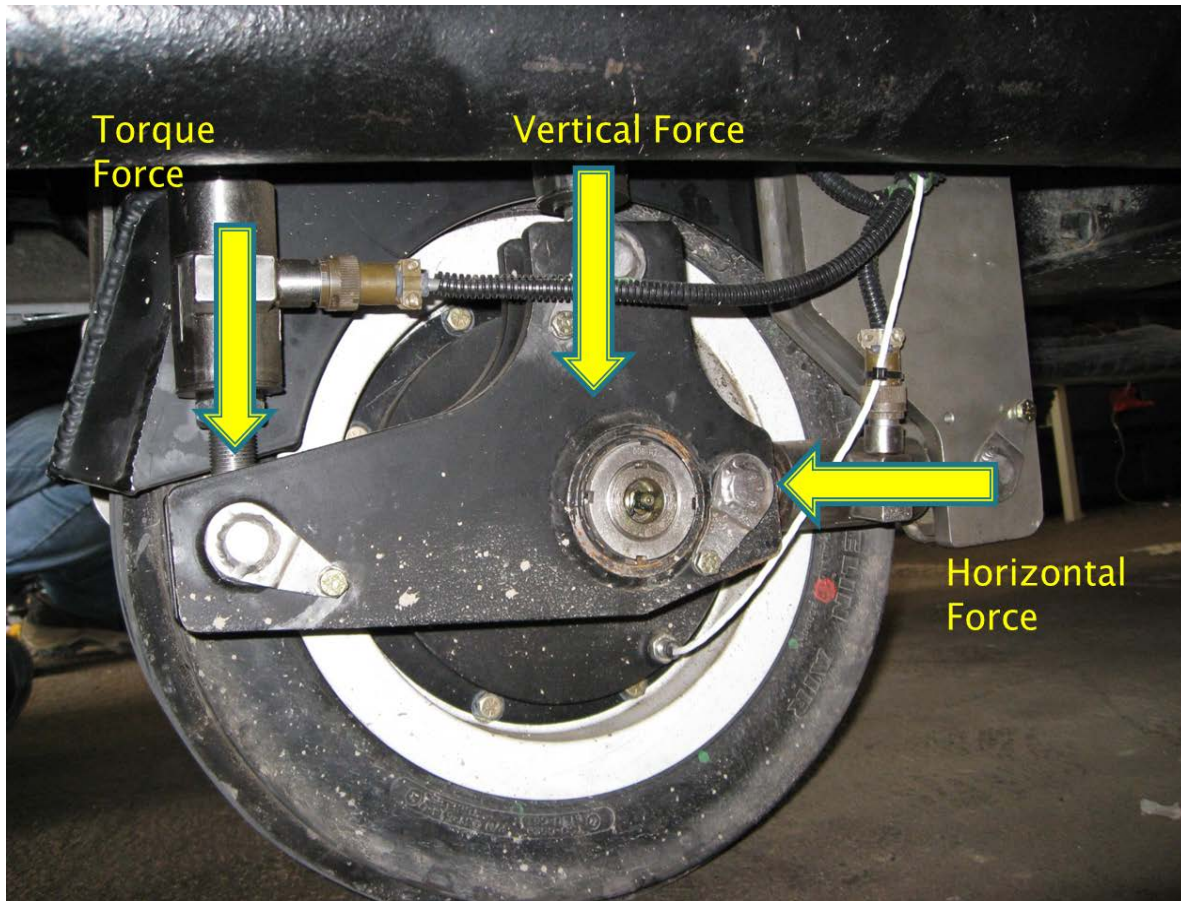

**Figure 6.5 - Load Cell Configuration**

The first load cell measures the vertical force applied on the BAT wheel. The primary source of vertical force is the applied load from the hydraulic cylinder. The vertical force load cell is capable of measuring applied loads ranging from 0 kN to 13.3 kN (0 lbs. to 3000 lbs.). The vertical force obtained by this load sensor will be used to calculate the normal force applied on the BAT wheel.

The second load cell on the BAT wheel is the horizontal load cell. The horizontal load cell measures the horizontal force being applied on the BAT wheel. The horizontal force load cell is capable of measuring applied loads ranging from 0 kN to 8.9 kN (0 lbs. to 2000 lbs.). The horizontal force applied on the BAT wheel is a result of the motion of the BAT wheel on pavement. The measured horizontal force will be used to calculate the drag force on the BAT wheel.

The third and final load cell on the BAT wheel measures the torque force applied on the BAT wheel. The torque force is generated because the applied load from the hydraulic cylinder is not applied directly to the centre of the BAT wheel. The vertical load is applied to an arm which is connected to the centre of the BAT wheel. Applying the vertical load to an arm which is offset from the centre of the BAT wheel generates the torque force on the BAT wheel. The torque force load cell is capable of measuring applied loads ranging from 0 kN to 17.8 kN (0 lbs. to 4000 lbs.). The torque force obtained by this load sensor will be used to calculate the anti-slip forces on the BAT wheel.

Figure 6.6 shows sample output from the BAT wheel comparing the vertical, horizontal and torque loads applied on the BAT wheel during touchdown.

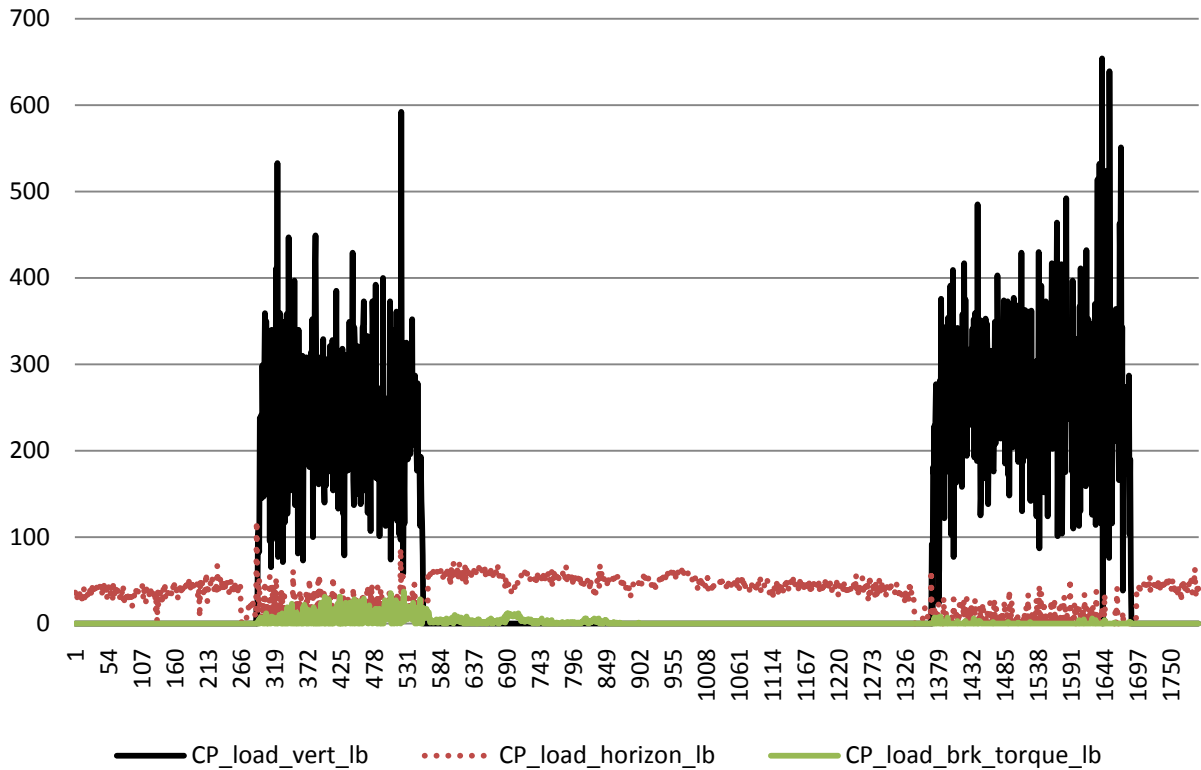

**Figure 6.6 - Sample Vertical load, Horizontal Load and Brake Torque**

Figure 6.6 shows a sample trial illustrating the type of results expected from the BAT wheel load cells during the touchdown. The trial presented shows there is a spike in vertical load during the period where the BAT wheel was in the touchdown position. The BAT wheel was lifted off the pavement during phases where there was no vertical load measured. The data shown in Figure 6.6 is only for touchdown, the brakes were not applied during this trial. If the brakes had been applied to the BAT wheel the horizontal and torque loads would be much higher than shown in Figure 6.6.

Calculating the normal force from the vertical load cell, the drag force from the horizontal load cell, and the anti-slip forces from the torque load cell provided the information required to determine the frictional coefficients and braking distance of the BAT wheel. By modifying the vertical load applied on the BAT wheel, the information measured by the load cells can be scaled and extrapolated to model the anticipated braking action of aircrafts.

### 6.2.6 Speed Sensors

There are three speed sensors on the BAT. The first two speed sensors measure the speed of the test truck vehicle, while the third sensor measures the speed of the BAT wheel. Of the two speed sensors measuring the truck speed, one sensor is built into the original F-350 truck, and measures the wheel speed of one of the truck tires, the second sensor was added to the truck, and uses GPS to measure the

speed of the truck. The built-in speed sensor and added GPS speed sensor are designed and calibrated to measure the same speed value, and the output is in in km/hour. The maximum speed that the sensors will measure is bounded by the truck speed capability; in other words the speed sensors are capable of measuring speeds much greater than what the truck can possibly achieve. Although the GPS speed sensor is redundant, it was added to the truck because the measurement from the GPS speed sensor is easier to integrate into the operator console and braking distance calculations than using the built in speed measurements from the truck. In addition, the GPS speed sensor is necessary because it records the speed of the truck throughout the entire operation, whereas the built-in truck speed sensor was not designed to store the vehicle speed. For the test results to be reliable, it is important that the vehicle maintains a constant speed during the BAT wheel landing and braking test. This sensor will confirm the speed of the BAT and will identify any fluctuation in the vehicle speed during the BAT braking test.

The third speed sensor is on the BAT wheel; as such it measures the speed of the BAT wheel relative to the ground. Similar to the other speed sensors, this speed sensor is designed and calibrated to measure and record the wheel speed in km/hour, where the upper bound speed that the sensors will measure is limited by the maximum possible speed of the wheel.

Figure 6.7 shows the speed of the BAT wheel and the speed of the truck during a Trial run to calibrate the speed sensors. As Figure 6.7 shows, the speed of the BAT wheel was 0km/hr until touchdown periods, where the speed of the BAT wheel matched the speed of the Truck obtained from the GPS Sensors.

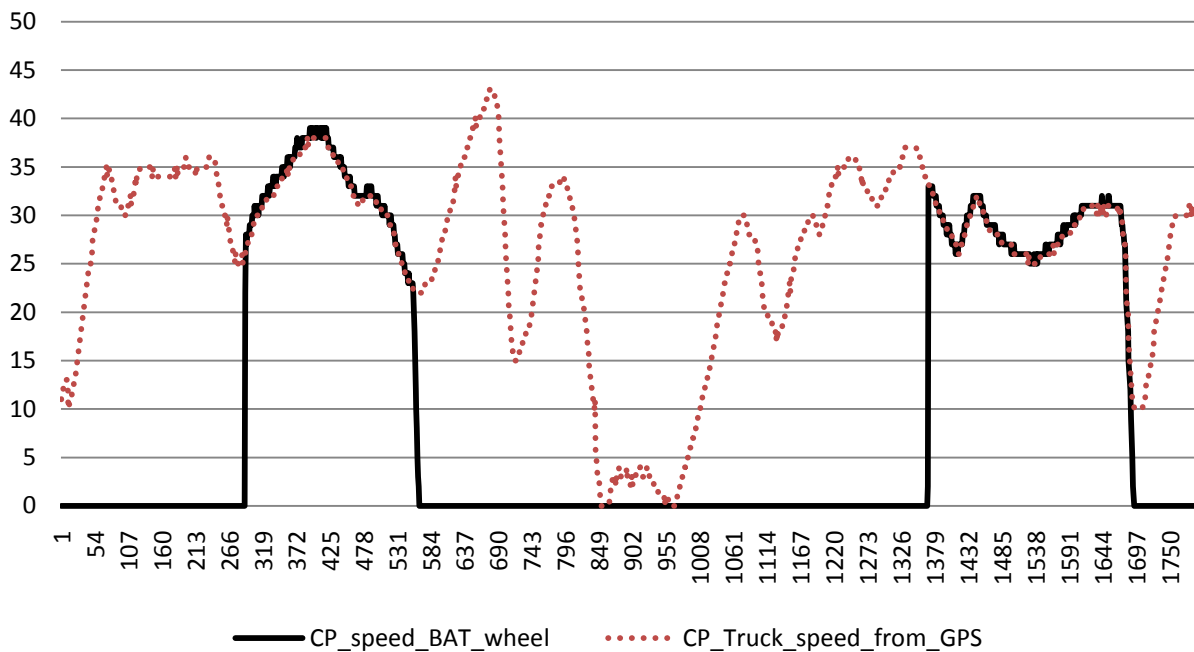

**Figure 6.7 - BAT Wheel speed and GPS Speed (Sample data)**



Comparing the speed of the truck to the speed of the BAT wheel is an indicator of whether the BAT wheel is moving freely or skidding. Figure 6.7 shows the BAT wheel rolling freely without the brakes being applied. Following the BAT wheel touchdown, and immediately before applying the brake to the BAT wheel the vehicle speed and the BAT wheel speed should be equal. The difference between the wheel speed and the vehicle speed is called the slip ratio. The best slip ratio (i.e. maximum braking slip ratio) is around 10% to 14% in typical cases. If the speed of the BAT wheel is not equal to the speed of the truck, then the wheel is not rolling freely and the tire is skidding. When the brakes are applied to the BAT wheel, slipping is supposed to occur, as slipping is what causes the wheel to stop. Measuring slip and using the speed sensors to determine how fast the BAT wheel stops provides more information for calculating an aircraft braking distance.

### 6.2.7 Proportional Valve and Solenoid

The proportional valve is a valve on the hydraulic line used to regulate the flow of hydraulic fluid to the braking caliper. The proportional valve is located in the hydraulic line, past the solenoid and near the BAT wheel. Figure 6.8 shows the setup of the Proportional valve, the solenoid and hydraulic line.

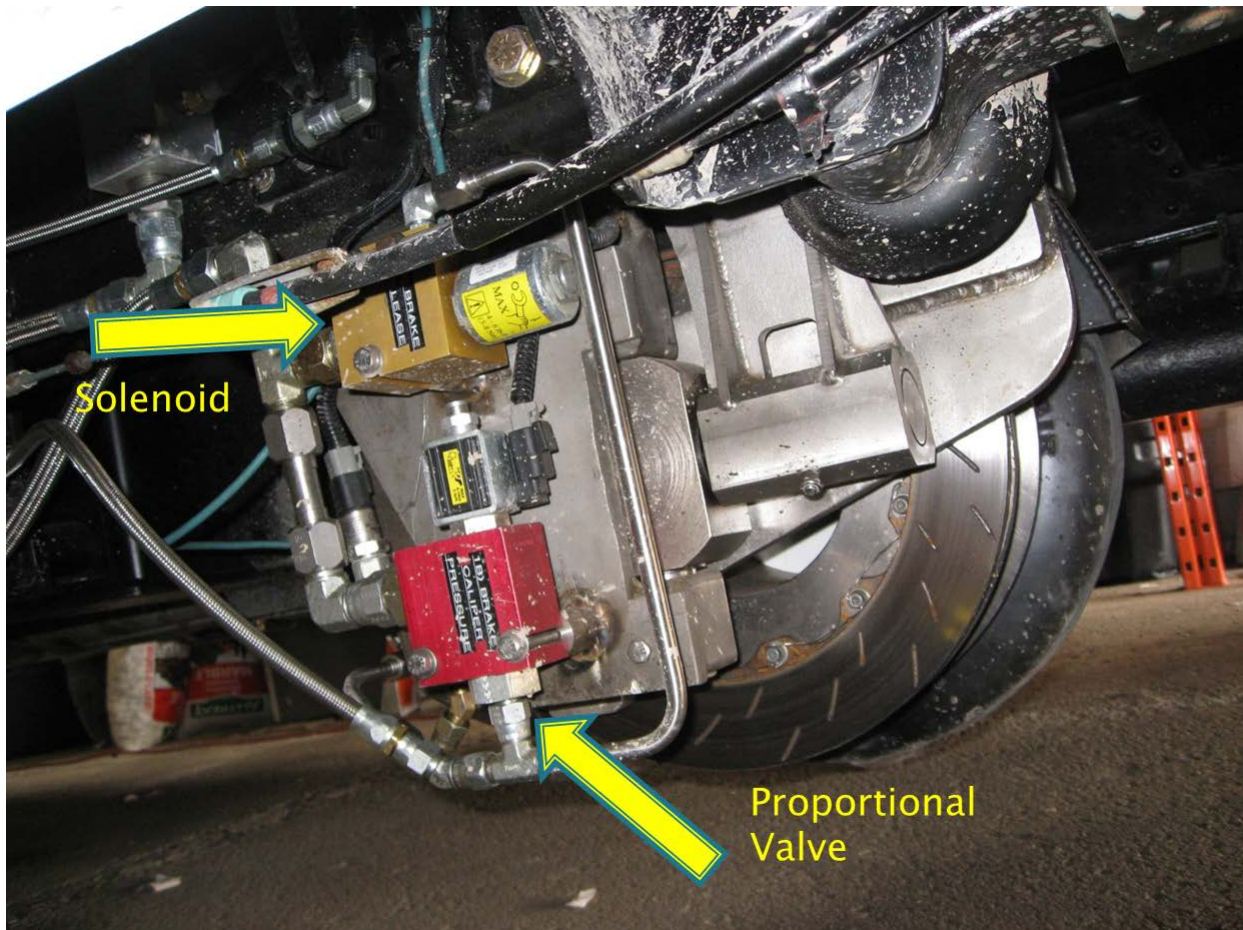

Figure 6.8 - Proportional Valve and Hydraulic line at the BAT Wheel

For braking action to occur, hydraulic fluid flows through the solenoid, which simply stated is a valve that must be in the open position, for hydraulic fluid to continue flowing to the braking system. After passing the solenoid, the hydraulic fluid goes through the proportional valve. The diameter of the opening in the proportional valve can be increased or decreased to change the pressure in the hydraulic line. After passing through the proportional valve, the hydraulic fluid exerts force on the braking calipers, thus causing braking action on the BAT wheel.

The decision to apply brakes and the magnitude of braking action can be controlled by changing the diameter of the opening at the proportional valve. When the proportional valve is fully opened, hydraulic fluid flows freely past the braking calipers, and the brakes are not applied to the BAT wheel. When the proportional valve is not fully open and is restricting the fluid flowing through the hydraulic line, a backpressure is created. This backpressure exerts force on the braking calipers, causing the brakes to be applied to the BAT wheel. The diameter of the proportional valve is controlled by an algorithm designed to simulate the antiskid braking systems commonly used in commercial aircrafts.

### **6.3 Antiskid Braking Algorithm**

Antiskid braking is commonly used on commercial aircrafts to provide better control of the aircraft. Antiskid braking in aircrafts is quite similar in concept to ABS braking in cars. When the driver of a vehicle without ABS braking fully applies the brakes to stop their vehicle, the wheels skid but the vehicle will stop. While the wheels are skidding, the driver of the vehicle does not have full control over the car. When the driver of a car with ABS engaged fully applies the brakes, an algorithm in the ABS braking will automatically override the application of brakes when skidding begins to occur. As such, the brakes are released to prevent skidding; however, cycling through releasing and applying the brakes also increases the braking distance of the vehicle.

The ABS algorithm in aircrafts operates quite similarly to ABS braking in cars; the brakes are released when the aircraft tires begin to skid, and reapplied after skidding is prevented. ABS does not necessarily increase the braking distance. On uniform surfaces, ABS is intended to keep the tire-pavement friction at its maximum value. The problem occurs when the pavement surface is covered by deformable contaminants. In this case, the ABS cyclically releasing and applying the brakes may cause a longer braking distance than just continuously applying the brakes to the aircraft tires. The longer braking distance caused by the continual engaging and releasing of the braking system may lead to a runway overrun.

In aircrafts, there are several mechanisms that cause the aircraft to stop, including aerodynamic drag and application of reverse thrusters. However, wheel braking still accounts for a portion of the braking action of the aircraft.

The braking system on the BAT is what sets the device apart from other runway friction testers, as it includes an antiskid braking algorithm that controls the braking action of the BAT wheel. This algorithm is designed to simulate the antiskid braking algorithm typically used on an aircraft. The antiskid braking algorithm uses data from the speed sensors as inputs for the antiskid braking algorithm. Based on the speed of the truck and the speed of the BAT wheel, the algorithm can detect whether or not slipping is occurring. The antiskid braking algorithm then controls the proportional

valve, which in turn controls the amount of braking action applied to the BAT wheel. If the antiskid braking algorithm determines that slipping is occurring, the antiskid braking algorithm will send a signal to the proportional valve causing the proportional valve to open in diameter. This will decrease the backpressure in the hydraulic line being applied to the braking calipers, and thus release the brakes from being applied on the BAT wheel. Once the risk of slipping ceases, the braking algorithm sends a signal to the proportional valve causing the proportional valve to decrease in diameter. This causes an increase in hydraulic backpressure and braking action is applied to the BAT wheel. As long as the operator of the BAT is applying the brakes to the BAT wheel, the antiskid braking cycle will continue to repeat until the BAT wheel comes to a full stop.

The concept of the BAT is to simulate the antiskid braking action that typically occurs in an aircraft landing gear system by simulating the applied load and antiskid braking technique on the BAT wheel. The end goal is to use the data obtained from the BAT to calculate an anticipated braking distance that can be correlated to the anticipated braking distance of an aircraft.

#### **6.4 Framework for BAT Calibration Procedure**

As part of this research, the initial testing plan has been established. It is proposed that during initial testing, the BAT will be tested on the primary runway of the Region of Waterloo International Airport. This runway is approximately 2100 m long (7000 ft.) and has an asphalt surface. Each test of the BAT includes a pre-aircraft landing BAT test, observing a Boeing 737 landing, and a post-aircraft landing BAT test.

During each trial, the environmental conditions including the ambient air temperature, the wind speed and direction, and the type and severity of precipitation (if applicable) will be measured and recorded. The type, depth, density and approximate runway coverage of observed environmental contaminants such as water, snow and ice on the runway will also be measured during each field test. Information that the Region of Waterloo International Airport operations team regularly collects to ascertain runway conditions will also be used to supplement the field data collected.

The hydraulic wheel of the BAT will be lowered during each trial to simulate touchdown. The touchdown of the BAT wheel will occur at the touchdown point on the primary runway; the BAT brakes will be applied to the BAT wheel until the wheel comes to a stop.

With permission from the airport air traffic control, the BAT will run down the runway prior to the scheduled landing of a Boeing 737 for a pre-aircraft landing test according to the pattern shown in Figure 6.9. This trial will be recorded and the data from the pre-aircraft landing trial was stored. The scheduled Boeing 737 will then land and the conditions surrounding the landing of the aircraft will be observed and recorded.

Then, with permission from air traffic control, the BAT runway test will be repeated (according to Figure 6.9) after the Boeing 737 had exited the runway. Where possible, video recordings should be made of each BAT test and associated aircraft landing.

The recommended testing procedure for the bat is to BAT collect measurements on the right side of the runway, left side of the runway and then along centreline, as shown in Figure 6.9. As Figure 6.9

shows, tests will be conducted from both approaches of the runway, i.e. R-08, L-26; L-08, R-26, CL-08, CL-26.

Technical reports on the development of the BAT will be created, along with recommended practices for the correct usage of this device, as they become available.

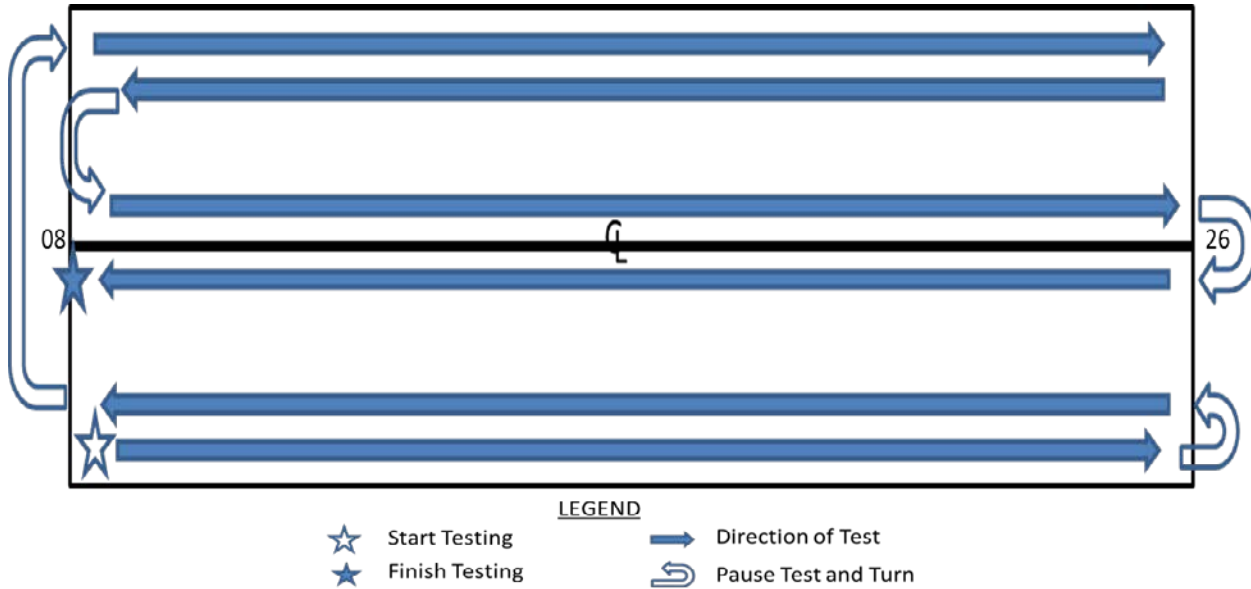

**Figure 6.9 – Proposed Pattern for Runway Testing the BAT**

The BAT should be tested for a statistically significant number of trials on the asphalt runway under a variety of in-situ pavement conditions and over a wide range of temperatures typical in the Canadian climate. A statistically significant number of trials was deemed to be three trials of the BAT for every 2 °C (3.6 °F) increase in temperature ranging starting at -20°C going up to 20°C (-4°F to 68°F). These trials also included dry pavement, and various contaminants on the pavement, including winter contaminants and wet pavement.

Information about the landing aircrafts is being collected from the airlines, through reviewing Pilot Reports (PIREPS) and through retrieving information from flight data recorders where possible. Specifically, black box information will be used to determine the actual braking distance of the landing aircraft and the extent that non-aerodynamic braking action was involved in stopping the aircraft.

In addition, the Region of Waterloo International Airport is providing the University of Waterloo with regular runway condition evaluations. These evaluations indicate the time the survey was collected, the weather conditions and visibility during the survey, the type of runway contaminant, and percentage of runway covered with contaminant.

Results measured by the BAT will then be compared to the conditions the braking aircraft experienced to determine the correlation between the braking distance of the BAT wheel and the braking distance of actual aircrafts. The actual braking distance of a landing test aircraft, in

combination with weather reports, CRFI measurements PIREPs will be used in comparison to the left, right and centerline BAT measurements to determine a measurement of braking availability. This process is illustrated in Figure 6.10.

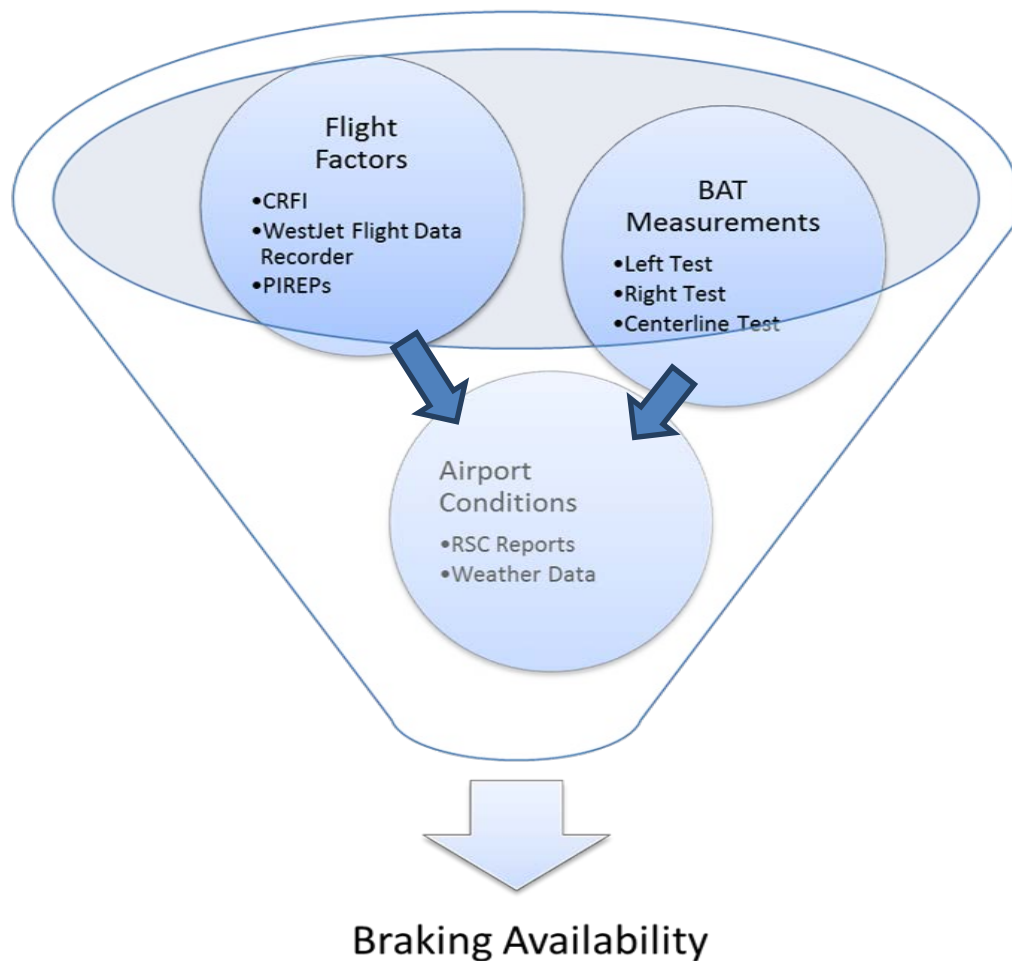

**Figure 6.10 - Inputs for Determining Braking Availability**

### **6.5 Key Testing Conditions**

The primary feature of the BAT that differentiates it from commonly used friction testers is the ABS on the test wheel that simulates the antiskid braking of aircrafts. As such, it is imperative that the BAT is calibrated on runways with contaminant conditions that will cause skidding. The BAT should also be tested on clean, uncontaminated runways as a control for the antiskid braking tests.

In the context of an airport, typical runway contaminants include rain water, loose or densely packed snow, ice, slush and rubber build up. Primary testing and calibration of the BAT will occur using a Boeing 737 as the test aircraft at the Region of Waterloo International Airport, in Ontario,

Canada. Typical winter contaminants to be expected in southwestern Ontario include snow, ice and rain. To ensure that the BAT is tested under a variety of contaminant conditions, temperatures and altitudes, the BAT should be tested in different regions of North America. Conditions atypical to the Waterloo Region include freezing rain, dense fog, hail and heavy rain.

The BAT will initially be calibrated using a Boeing 737 to draw correlations between the runway conditions and the estimated braking distance of the aircraft. Future calibration efforts should include comparing the BAT to other commonly used commercial aircrafts and their braking systems.

Long-term calibration studies of the BAT can include analysis of the impact the runway pavement condition and primary runway surface material has on the expected braking performance of aircrafts.

## **6.6 Anticipated Significance of the BAT**

This primary goal of this work is to ensure safety on all airport pavements by improving the scope and quality of information regarding runway condition. The BAT will specifically advance the aviation industry's fundamental knowledge and understanding of the effect and impact deformable contaminants have on runway braking availability. To ensure safe runway operations, it is critical that insitu conditions are accurately quantified and reported to pilots, airlines and airport decision makers.

The BAT and results from the research program could provide support to the FAA, Transport Canada, the International Civil Aviation Organization (ICAO) and the international airport community at large. In application, the BAT will provide information that can be used to identify areas requiring contaminant removal. Additionally, the results of the Braking Availability Tester can be used by airlines, pilots and airport operators for making critical decisions regarding aircraft dispatch, and scheduling of landings.

In the long run, results and data collected from the BAT can be incorporated into an airport's pavement management system. It is anticipated that the BAT will provide information that can be extrapolated to determine pavement surface condition, the rate of contaminant accumulation and the effect pavement temperature has on the pavement structure and friction characteristics of the runway. This information can be used by airport owners, managers and policy makers to effectively schedule maintenance and rehabilitation treatments.

When applied to APMS, it is anticipated that the results from the BAT and this research program will contribute to advancing pavement management and maintenance in the aviation industry.

## **6.7 Chapter Summary**

This chapter introduced the Braking Availability Tester (BAT) as a device that is being developed in partnership with Team Eagle Ltd., the Ontario Centres of Excellence and the University of Waterloo Centre for Pavement and Transportation Technology. The goal of the BAT is to provide more information regarding braking availability, especially in the presence of deformable contaminants. The BAT is different from current CFME testers as it incorporates an aircraft antiskid braking algorithm that controls the braking force applied to the test wheel.

The purpose of key sensors and components of the BAT are summarized in Table 6.1.

**Table 6.1- Summary of Key Sensors and Components of the BAT**

<b>Sensor</b>	<b>Purpose</b>
Thermocouples	Measure ambient air temperature, and braking caliper temperature
Infrared Temperature Sensor	Measure braking caliper temperature
Hydraulic Cylinder and Pressure Sensor	Raising and lowering BAT wheel, controls touchdown and vertical load applied to BAT wheel
Load Cells	Measures vertical, horizontal and torque force applied to BAT wheel
Speed Sensors	Measure truck speed and BAT wheel speed
Proportional valve and solenoid	Regulates flow of hydraulic fluid to braking caliper to cause and release brake application
Antiskid Braking Algorithm	Releases brake when slip is detected, reapplies brake when rotation overcomes slip; simulates aircraft ABS algorithm

The framework for testing and validating the BAT was also presented in this section. Initial testing will occur at the Region of Waterloo International Airport. Results from the BAT will be compared to flight data recorder information, weather reports, CRFI numbers and PIREPs where available. The BAT data will be compared to the actual landing distance of a test aircraft to determine the relationship between BAT data and runway braking availability.

The significance of this work is primarily improving aviation safety by providing pilots with real time information regarding runway braking availability. The BAT is unique to the aviation industry as it measures runway conditions using a braking system controlled by an antiskid braking system algorithm.

### **6.7.1 Chapter Key Points**

This research has proposed initial testing protocols for validating the BAT technology. The proposed Braking Availability Tester will contribute to the Aviation industry by:

- Uniquely incorporating the effect an aircraft antiskid braking system has on braking distances when a deformable contaminant is present.
- Providing pilots with real time, accurate and reliable information regarding runway braking availability. This information can be used to estimate landing distance requirements and make decisions about runway space in rejected take off situation.
- Advancing state of the art pavement management and maintenance practices.

## **Chapter 7**

### **Conclusion and Recommendations**

In December 2005, a runway overrun at Chicago Midway Airport occurred whereby the aircraft landed on a contaminated runway surface and was unable to safely stop within the confines of the runway. While pilot error contributed to the overrun, the accident could likely have been prevented if the effect of antiskid braking on the given contaminant had been properly understood and communicated to pilots so it could be correctly accounted for in landing distance calculations.

The following six objectives of this research were identified at the beginning of this thesis:

Objective 1: Review literature to provide background information regarding current state of the practice for measuring and reporting runway contaminants.

Objective 2: Review runway pavement design and management practices, focusing on the impact design and management has on pavement friction and runway performance.

Objective 3: Present methods for runway rubber removal and a decision making tool airports can incorporate in their pavement management system for selecting the best removal method.

Objective 4: Review Runway Surface Condition Reports and provide recommendations Transport Canada can employ in Canadian aerodromes to improve runway condition data collection and real time reporting to pilots.

Objective 5: Introduce the Braking Availability Tester (BAT), discuss how the BAT can be calibrated and utilized to provide pilots with expected runway braking availability.

Objective 6: Discuss how the BAT can be used to provide information that can be incorporated in an airport's pavement management system and used for making maintenance and rehabilitation decisions that will extend pavement life and improve runway performance.

The following sections describe how the aforementioned goals were addressed by this thesis.

#### **7.1 Key Findings from Literature Review**

This thesis included a literature review discussing the current state of the practice in the Canadian aviation industry for measuring and reporting runway friction. In Canada, the Canadian Runway Friction Index (CRFI) is used by pilots to calculate landing distances. CRFI measurements do not account for antiskid braking systems (ABS) and the extra distance associated with ABS use when stopping on deformable contaminants. The international aviation community relies on Pilot Reports (PIREPs) to provide information to supplement runway monitoring, as well as to document and share the conditions pilots experienced when landing their aircraft. Canadian aerodromes rely heavily on PIREPs to detect wind shear.

Following the Southwest accident at Chicago Midway Airport in 2005, the Takeoff and Landing Performance Assessment Aviation Rulemaking Committee (TALPA ARC) was created to identify shortcomings in state of practice methods for measuring runway contaminants and reporting to pilots. One of the outcomes of the TALPA ARC committee was recommending subjectivity be removed from Notice to Airmen (NOTAMs) reports.



The literature review also included a brief discussion of the braking system used by the Boeing 737 aircraft; one of the most commonly used commercial aircrafts. This aircraft will be used to validate results from BAT trials.

Lastly, the literature review provided information regarding the history of airport runway pavement design. An overview of pavement management techniques, including current friction testing practices and winter runway operation management planning were also discussed.

Following the literature review, it was identified that a more detailed analysis of pavement design and management was required. Furthermore, this thesis includes a study of contaminant accumulation and removal (in relation to pavement management), and a proposed framework for testing and reporting the effects of contaminants. The common theme of the literature review and the research following the background investigation is improving runway safety and performance through pavement management systems.

## **7.2 Finding from Review of Airport Pavement Design and Management**

The next objective of reviewing runway pavement design and management practices, focusing on the impact design and management has on pavement friction and runway performance was accomplished by reviewing FAA design standards and programs used for runway design. Both rigid pavement in the form of Portland Cement Concrete (PCC) and flexible pavement in the form of asphalt were considered and discussed in terms of best practices for design, material selection and construction to optimize runway friction.

The concept of utilizing Airport Pavement Management Systems (APMS) to monitor pavement condition and make funding decisions was further developed. An analysis of APMS and the primary advantages and costs associated with their use was conducted.

The key recommendation for airport pavement design is to select a surface material that will provide good friction properties. Ensuring proper construction and aggregate bonding is critical to preventing Foreign Object Debris from developing and threatening runway safety.

The key recommendation regarding airport pavement management is to utilize an APMS for collecting and storing pavement condition data. The users of the APMS must be adequately trained in data collection, input and analysis. The analysis of the APMS can be used to economically schedule maintenance and rehabilitation treatments. The APMS can also be used for allocating and prioritizing snow removal equipment and any other high demand resources.

## **7.3 Rubber Removal Alternatives Summary**

The next objective of this thesis was to identify and analyze methods commonly used for runway rubber removal. The four techniques for rubber removal discussed in this thesis are chemical removal, waterblasting, shotblasting and mechanical removal. Chemical removal and waterblasting are most the most commonly used rubber removal techniques; shotblasting and mechanical removal are primarily used for runway surface retexturing whereby rubber removal is an added benefit. Advantages, disadvantages, cost and potential damage to pavement were discussed for each of the rubber removal alternatives.

In connection with the theme of airport pavement management, an analytical hierarchy process (AHP) decision making tool that can be incorporated by airports into their pavement management system was created. The AHP tool presented is a resource airports can customize and employ in their APMS for selecting the best rubber removal method to meet their specific needs.

It is recommended that the rate of rubber accumulation be regularly monitored and removed in a timely manner, as required. Airports with high volume traffic or a large portion of heavy aircrafts landing should perform more frequent rubber friction tests.

An additional recommendation is that airport pavement should be designed and constructed with the preferred rubber removal technique considered. Airports that frequently resurface the pavement using shotblasting and mechanical removal must overdesign the runway pavement structure to account for structural loss as a result of removing thickness when retexturing the runway.

#### **7.4 Runway Surface Condition Reporting Improvements**

Runway Surface Condition (RSC) reports created by the Region of Waterloo between November 2010 and March 2012 were reviewed. Factors such as the objectivity of measurements, the frequency of reporting, the method of communicating information to pilots, the descriptive quality of terminology used in RSC reports, and how contaminants are quantified and classified were considered. Based on this review, recommendations were provided for improving runway condition data collection and real time reporting to pilots in Canadian aerodromes.

Results from RSC surveys need to be communicated with pilots in real time. Measuring techniques and terminology used for describing runway conditions needs to become standardized to ensure consistency in reporting. It would be useful to provide pilots with pictures of the runway that identify the location of runway contaminants. The RSC reports should be stored in the airport's pavement management system, to observe seasonal patterns and better identify trends in friction and braking availability characteristics of the airport's runways

Canadian airports should install equipment that measures wind shear to reduce dependency on Pilot Reports (PIREPs). Pilot reports provide meaningful information, but should become more standardized to reduce subjectivity in reporting.

#### **7.5 Role of the Braking Availability Tester and Proposed Framework for Calibration and Validation**

The Braking Availability Tester (BAT) was introduced as a machine that will provide pilots with real time information regarding the effect deformable contaminants will have on landing distances. The mechanical sensors, unique incorporation of aircraft antiskid braking systems in the measuring of braking availability, and distinguishing features of the BAT were discussed.

A framework for testing the BAT was proposed and key testing conditions for validating BAT results were identified. Results from BAT validation trials should be compared to flight data recorder information, environmental weather reports, airport RSC reports, CRFI measurements and PIREPs where possible.

In the short term, the data obtained from the BAT should be further analyzed and compared to industry standards and reviewed by the aviation community to determine whether modifications are required to the BAT to improve the BAT data collection and quality of results.

The sensors in the BAT should be continually calibrated and verified to ensure their accuracy and reliability. As the BAT will be primarily tested at the Region of Waterloo International Airport, on an asphalt pavement, the BAT should also be tested at several other international airports to improve the reliability of results.

Additional factors to consider are how the runway elevation, aircraft loading and material of the runway (asphalt concrete or Portland cement) affect braking distance. To improve the reliability of the correlation results, further trials should be conducted using the BAT at a variety of airports under a variety of pavement contaminant conditions and ambient temperatures. The BAT should also be compared to a variety of aircraft models, to increase the relevance of the results of the BAT to the aviation industry.

## **7.6 Incorporating BAT Data into APMS and Runway Pavement Optimization**

The final component of this thesis was to discuss how results from the BAT can be incorporated into an airport's pavement management system. Ideally, BAT data will be used to provide information that will be used by airport operators, managers and policy makers for making maintenance and rehabilitation decisions that will extend pavement life and improve runway performance.

The key recommendation is that BAT data be considered an additional source of information regarding pavement condition. The BAT will provide meaningful data that can be used to establish surface distresses, riding quality, friction properties and the effect of contaminants. The BAT includes an infrared pavement temperature sensor which will provide results that may be used to analyze pavement performance.

The primary advantage of the BAT is that testing will occur frequently, especially in inclement weather situations, meaning there will be a large volume of information available. In addition, the data output is designed to be intuitive and user friendly, so it can easily be incorporated into an APMS for monitoring, analyzing and optimizing pavement performance.

## **Appendix A**

### **Glossary of Terms**

ABS	Antiskid Braking System
ACRP	Airport Cooperative Research Program
ADF	Automatic Direction Finder
AFCESA	Air Force Civil Engineering Support Agency
AHP	Analytical Hierarchy Process
APMS	Airport Pavement Management System
ARC	Aviation Rulemaking Committee
ATC	Air Traffic Control
BAT	Braking Availability Tester
CBR	California Bearing Ratio
CDF	Cumulative Damage Factor
CFME	Continuous Friction Measuring Equipment
CPATT	Centre for Pavement Transportation Technology
CRFI	Canadian Runway Friction Index
FAA	Federal Aviation Administration
FAARFIELD	FAA Rigid and Flexible Iterative Elastic Layer Design
FIC	Flight Information Centre
FOD	Foreign Object Debris
GPS	Global Positioning System
HMA	Hot Mix Asphalt
HVIR	High Velocity Impact Removal
ICAO	International Civil Aviation Organization
ILS	Instrument Landing System
IRF	Instrument Flight Rules
IRFI	International Runway Friction Index
JBD	James Break Decelerometer

JB I	James Brake Index
JWFRP	Joint Winter Runway Friction Program
LDR	Landing Distance Required
MLS	Microwave Landing System
NASA	National Aeronautics and Space Administration
NAVAIDS	Navigational Aids
NDB	Non-Directional Beacon
NLA	New Large Aircraft
NOTAM	Notice to Airmen
NRC	National Research Council of Canada
NWS	National Weather Service
OCE	Ontario Centres of Excellence
PAR	Precision Approach Radar
PCC	Portland Cement Concrete
PIREP	Pilot Report
PMS	Pavement Management System
PRCAT	Paved Runway Condition Assessment Table
RSC	Runway Surface Condition
RTO	Rejected Takeoff
SW	Southwest Airline
TAC	Transportation Association of Canada
TALPA	Takeoff and Landing Performance Assessment
TC	Transport Canada
VOR	Very High Frequency Omnidirectional Range

## Appendix B

### Conversion Factors for Imperial to Metric Units

	Imperial	Metric Equivalent
Length	1 inch (in)	25.4 mm
	1 feet (ft.)	0.305 m
	1 yard (yd.)	0.914 m
	1 miles (mi)	1.61 km
Area	1 square inch (sq. in)	645.1 mm <sup>2</sup>
	1 square foot (sqft)	0.093 m <sup>2</sup>
	1 square yard (sq. yd.)	0.836 m <sup>2</sup>
Volume	1 gallon	3.785 L
Mass	1 pound	0.454 kg
Force	1 pound force (lbf)	4.54 N
Pressure	1 pound force per square inch	6.89 kPa
Speed	1 knot (kt)	0.514 m/s
Temperature	Fahrenheit temperature (°F) (F – 32)/1.8 Celsius temperature (°C)	

## References

- [AFCESA, 2004] Air Force Civil Engineering Support Agency (AFCESA). (2004, May 12). *Engineering Technical Letter (ETL) 04-10 (Change 1): Determining the Need for Runway Rubber Removal*. Retrieved April 28, 2012, from [http://www.wbdg.org/ccb/AF/AFETL/etl\\_04\\_10.pdf](http://www.wbdg.org/ccb/AF/AFETL/etl_04_10.pdf)
- [Airbus, 2007] Airbus and Flight Safety Foundation. (2007, October 27). *Adverse Weather Operations Windshear Awareness*. Retrieved May 27, 2012, from Flight Operations Briefing Notes : [http://www.airbus.com/fileadmin/media\\_gallery/files/safety\\_library\\_items/AirbusSafetyLib\\_-FLT\\_OPS-ADV\\_WX-SEQ02.pdf](http://www.airbus.com/fileadmin/media_gallery/files/safety_library_items/AirbusSafetyLib_-FLT_OPS-ADV_WX-SEQ02.pdf)
- [ACRP, 2008a] Airport Cooperative Research Program (ACRP). *ACRP Report 3: Analysis of Aircraft Overruns and Undershoots for Runway Safety Areas*. Washington, DC: Transportation Research Board. 2008.
- [ACRP, 2008b] Airport Cooperative Research Program (ACRP). (2008). *ACRP Synthesis 11 Impact of Airport Rubber removal techniques on Runways*. Washington, DC: Transportation Research Board
- [Airport, 2011] Airport-Technology.com. (2011). Retrieved May 15, 2012, from Waterblasting Technologies - Non-Destructive Rubber and Pavement Marking Removal Systems: [http://www.airport-technology.com/contractors/apron\\_clean/waterblasting-technologies/](http://www.airport-technology.com/contractors/apron_clean/waterblasting-technologies/)
- [Bangkok, 2008] Bangkok Aviation Center. (2008). *Runway Rubber Removal*. Retrieved May 03, 2012, from <http://www.bangkokflying.com/th/knowledgeview.aspx?id=5>
- [Dynatest, 2010] Dynatest. (2010). *Airports PMS: Technical Description Airport Pavement Management System*. Glostrup, Denmark.

- [FAA, 2009a] Federal Aviation Administration (FAA) US Department of Transportation. (2009, September 30). *Advisory Circular 150/5320-6E Airport Pavement Design and Evaluation*. Retrieved May 15, 2012, from [http://www.faa.gov/documentLibrary/media/Advisory\\_Circular/150\\_5320\\_6e.pdf](http://www.faa.gov/documentLibrary/media/Advisory_Circular/150_5320_6e.pdf)
- [FAA, 2009b] Federal Aviation Administration (FAA). "TALPA ARC Airport/ Part 139 Working Group Recommendations." 2009.
- [FAA, 2011a] Federal Aviation Administration (FAA). (September, 7 2011). Airport Obligations: Pavement Maintenance. Retrieved June 30, 2012, from [http://www.faa.gov/airports/central/airport\\_compliance/pavement\\_maintenance/](http://www.faa.gov/airports/central/airport_compliance/pavement_maintenance/)
- [FAA, 2011b] Federal Aviation Administration (FAA). (2011, February 4). Lessons Learned from Transport Airplane Accidents. Retrieved July 7, 2011, from Southwest Flight 1248 at Midway: [http://accidents-ll.faa.gov/ll\\_main.cfm?TabID=3&LLID=56&LLTypeID=2](http://accidents-ll.faa.gov/ll_main.cfm?TabID=3&LLID=56&LLTypeID=2)
- [FAA, 2012a] Federal Aviation Administration (FAA). (2012, February 9). Flight Services. Retrieved May 24, 2012, from Order JO 7110.10V: <http://www.faa.gov/documentLibrary/media/Order/FSS.pdf>
- [FAA, 2012b] Federal Aviation Administration (FAA). (n.d.). PIREP Form. Retrieved May 24, 2012, from [http://www.faa.gov/about/office\\_org/headquarters\\_offices/ato/service\\_units/systemops/fs/alaskan/alaska/fai/inflight/media/PIREP\\_FORM.pdf](http://www.faa.gov/about/office_org/headquarters_offices/ato/service_units/systemops/fs/alaskan/alaska/fai/inflight/media/PIREP_FORM.pdf)
- [Fwa, 1997] Fwa, T.A., W. T. Chan, and C.T. Lim. "Decision Framework for Pavement Friction Management of Airport Runways." *Journal of Transportation Engineering*, 1997: 429 - 435.
- [Giesman, 2007] Giesman, P. (2007). Landing on Slippery Runways. Boeing.



- [ICAO, 2012] International Civil Aviation Organization (ICAO). (Unpublished). Runway Surface Condition Assessment, Measurement and Reporting (CIR 329). Retrieved May 04, 2012, from [http://www.iata.org/iata/RERR-toolkit/assets/Content/Contributing%20Reports/ICAO\\_Circular\\_on\\_Rwy\\_Surface\\_Condition\\_Assessment\\_Measurement\\_and\\_Reporting.pdf](http://www.iata.org/iata/RERR-toolkit/assets/Content/Contributing%20Reports/ICAO_Circular_on_Rwy_Surface_Condition_Assessment_Measurement_and_Reporting.pdf)
- [Marchi, 2012] Marchi, Dick. Winter Operations Update ACI-NA. [http://74.209.241.69/static/entransit/marchi\\_matrix.pdf](http://74.209.241.69/static/entransit/marchi_matrix.pdf) (Accessed April 4 2012)
- [MTO, 2010] Ministry of Transportation Ontario (MTO). Ontario's Transportation Technology Transfer Digest — Summer 2010 — Vol. 16, Issue 3. September 22, 2010. <http://www.mto.gov.on.ca/english/transtek/roadtalk/rt16-3/> (accessed July 25, 2011).
- [NASA, 2008] National Aeronautics and Space Administration (NASA). (22, April 2008). Making the Skies safe from Windshear. Retrieved May 27, 2012, from <http://www.nasa.gov/centers/langley/news/factsheets/Windshear.html>
- [Nav Canada, 2011] Nav Canada. (2011). Canada Flight Supplement (Effective 0901Z 20 October 2011 to 0901Z 15 December 2011). Ottawa.
- [Speidel, 2002] Speidel, D. J. (2002). Airfield Rubber Removal. 2002 Federal Aviation Administration Technology Transfer Conference.
- [Thales, 2007] Thales Air Traffic Management Inc. The Glideslope. <http://www.thalesatminc.com/Technology/Glideslope.htm>. Accessed April 17, 2012)
- [Tighe, 2008] Tighe, S. Implementation of an Airport Pavement Management System. Transportation Research Board Circular E-C127, Washington, DC: Pavement Management Systems for Transportation Research Board Airports Subcommittee, 2008.

- [Touring, 2008] Touring Machine Company. (2008, September 21). Wind Shear Summary of AC 00-54. Retrieved May 27, 2012, from <http://www.touringmachine.com/Articles/weather/115/>
- [TAC, 1997] Transportation Association of Canada. Pavement Design and Management Guide. Ottawa: Transportation Association of Canada, 1997.
- [TAC, 2012] Transportation Association of Canada. (2012). Pavement Asset Design and Management Guide . Unpublished.
- [TC, 2010a] Transport Canada. (2010, May 03). Commercial and Business Aviation Advisory Circular. Retrieved March 17, 2012, from Canadian Runway Friction Index: <http://www.tc.gc.ca/eng/civilaviation/standards/commerce-circulars-ac0164-1657.htm>
- [TC, 2010b] Transport Canada. (2010, July 13). Environmental and runway surface conditions during friction tests at North Bay Airport: January-February 2002 (TP 14158E). Retrieved July 13, 2001, from Transportation Development Centre: <http://www.tc.gc.ca/eng/innovation/tdc-summary-14100-14158e-1338.htm>
- [TC, 2010c] Transport Canada. (2010, August 06). Joint Winter Runway Friction Measurement Program. Retrieved October 21, 2011, from Transportation Development Centre: <http://www.tc.gc.ca/eng/innovation/tdc-projects>
- [TC, 2012a] Transport Canada. (2012, March 15). Aircraft Movement Surface Condition Reports (AMSCR). Retrieved March 29, 2012, from Air 1.0 General Information: <http://www.tc.gc.ca/eng/civilaviation/publications/tp14371-air-1-0-462.htm#1-6-4>
- [TC, 2012b] Transport Canada. (2012, January 20). Aviation Safety Circular (ASC) 2004-024. Retrieved April 16, 2012, from <http://tc.gc.ca/eng/civilaviation/opssvs/nationalops-audinspmon-program-safetycirculars-2004024-862.htm>

- [TC, 2012c] Transport Canada. (2012, February 24). Met - 2.0 Pilot Reports. Retrieved May 24, 2012, from <http://www.tc.gc.ca/eng/civilaviation/publications/tp14371-met-2-0-2588.htm>
- [US, 2012] US Inflation Calculator. 2007 to 2012. <http://www.usinflationcalculator.com/>
- [Waterloo, 2012] Region of Waterloo International Airport. Aggregated Runway Surface Condition (RSC) Reports from TRACR distribution emailing list. November 2010 – March 2012.
- [Whitely, 2006] Whiteley, L. Pavement Thickness Design for Canadian Airports. Waterloo: University of Waterloo, 2006
- [Wells, 2004] Wells, A, and S. Young. Airport Planning & Management. New York, NY: McGraw Hill, 2004.
- [Yagger, 2006] Yagger, Thomas J. Runway Friction Measurement. Presented at FAA/ Aviation Industry Workshop on Runway Condition Determination, reporting and report dissemination. Washington, DC, August 2006.