

# The Steiner Ratio for the Obstacle-Avoiding Steiner Tree Problem

by

Mina Razaghpour

A thesis  
presented to the University of Waterloo  
in fulfillment of the  
thesis requirement for the degree of  
Master of Mathematics  
in  
Computer Science

Waterloo, Ontario, Canada, 2008

© Mina Razaghpour 2008

I hereby declare that I am the sole author of this thesis. This is a true copy of the thesis, including any required final revisions, as accepted by my examiners.

I understand that my thesis may be made electronically available to the public.

## Abstract

This thesis examines the (geometric) Steiner tree problem: Given a set of points  $P$  in the plane, find a shortest tree interconnecting all points in  $P$ , with the possibility of adding points outside  $P$ , called the *Steiner points*, as additional vertices of the tree. The Steiner tree problem has been studied in different metric spaces. In this thesis, we study the problem in Euclidean and rectilinear metrics.

One of the most natural heuristics for the Steiner tree problem is to use a minimum spanning tree, which can be found in  $O(n \log n)$  time [29, 35]. The performance ratio of this heuristic is given by the *Steiner ratio*, which is defined as the minimum possible ratio between the lengths of a minimum Steiner tree and a minimum spanning tree.

We survey the background literature on the Steiner ratio and study the generalization of the Steiner ratio to the case of obstacles. We introduce the concept of an *anchored Steiner tree*: an obstacle-avoiding Steiner tree in which the Steiner points are only allowed at obstacle corners. We define the *obstacle-avoiding Steiner ratio* as the ratio of the length of an obstacle-avoiding minimum Steiner tree to that of an anchored obstacle-avoiding minimum Steiner tree. We prove that, for the rectilinear metric, the obstacle-avoiding Steiner ratio is equal to the traditional (obstacle-free) Steiner ratio. We conjecture that this is also the case for the Euclidean metric and we prove this conjecture for three points and any number of obstacles.

## Acknowledgements

I would like to thank my supervisor, Anna Lubiw, for her guidance, encouragement and kindness, and for invaluable feedback throughout writing this thesis. I would also like to thank my readers, Jochen Könemann and Threes Biedel, for their critical reviews and valuable suggestions. I thank Glencorra Borradaile for insightful discussions we had. Lastly, I am deeply grateful to my mother, Ashraf Abtahi, for her support and encouragement in all my endeavors.

# Contents

<b>List of Figures</b>	<b>vii</b>
<b>1 Introduction</b>	<b>1</b>
1.1 Outline of the Thesis . . . . .	2
1.2 History of the Steiner Tree Problem . . . . .	2
<b>2 Background on the Steiner Tree Problem</b>	<b>5</b>
2.1 The Euclidean Steiner Tree Problem . . . . .	5
2.1.1 Complexity . . . . .	6
2.1.2 Exact Algorithms . . . . .	6
2.2 The Rectilinear Steiner Tree Problem . . . . .	7
2.2.1 Transformation to Steiner Problem in Graphs . . . . .	7
2.3 The Obstacle-Avoiding Euclidean Steiner Tree Problem . . . . .	8
2.4 The Obstacle-Avoiding Rectilinear Steiner Tree Problem . . . . .	9
2.4.1 Reduction to the Graph Steiner Tree problem . . . . .	10
<b>3 The Steiner Ratio</b>	<b>11</b>
3.1 The Euclidean Steiner Ratio . . . . .	12
3.1.1 Euclidean Steiner Ratio for $n = 3$ . . . . .	12
3.1.2 Euclidean Steiner Ratio Proof by Du and Hwang . . . . .	13
3.2 The Rectilinear Steiner Ratio . . . . .	19
3.2.1 Canonical Trees . . . . .	20
3.2.2 Rectilinear Steiner Ratio Proof by Salowe [42] . . . . .	26
3.2.3 Rectilinear Steiner Ratio Proof by Berman et al. [4] . . . . .	28
3.2.4 An Alternative Proof . . . . .	28

<b>4</b>	<b>Obstacle-Avoiding Steiner Ratio</b>	<b>33</b>
4.1	Euclidean Obstacle-Avoiding Steiner Ratio . . . . .	34
4.2	Obstacle Avoiding Rectilinear Steiner Ratio . . . . .	37
4.2.1	Canonical Obstacle-Avoiding Steiner Trees . . . . .	37
4.2.2	Proof of the Steiner Ratio Theorem (Theorem 4.3) . . . . .	38
<b>5</b>	<b>Approximation Algorithms</b>	<b>44</b>
5.1	Background on PTASs for the Steiner Tree Problem . . . . .	44
5.1.1	The Euclidean and Rectilinear Steiner Tree Problems . . . . .	44
5.1.2	The Graph Steiner Tree Problem . . . . .	44
5.1.3	The Euclidean and Rectilinear Obstacle-Avoiding Steiner Tree Problems . . . . .	45
5.2	Constant Factor Approximation Algorithm for the Obstacle-Avoiding Rectilinear Steiner Tree Problem . . . . .	46
<b>6</b>	<b>Conclusion</b>	<b>47</b>
	<b>References</b>	<b>48</b>

# List of Figures

1.1	A minimum Steiner tree . . . . .	1
1.2	Torricelli point. . . . .	3
2.1	Hanan grid graph for a set of 5 terminals. . . . .	8
3.1	An MST and an SMT for three corners of an equilateral triangle. . . . .	12
3.2	A minimum Steiner tree for three points. . . . .	13
3.3	Characteristic area. . . . .	16
3.4	A hexagonal tree. . . . .	17
3.5	A minimum Steiner tree and a minimum spanning tree with length ratio of 2/3. . . . .	19
3.6	Canonical Steiner trees . . . . .	20
3.7	minimum Steiner trees with less than 5 terminals . . . . .	21
3.8	(a) Shift (b) Flip . . . . .	21
3.9	Lemma 3.8 . . . . .	22
3.10	Lemma 3.9 . . . . .	23
3.11	Lemma 3.10 . . . . .	23
3.12	A Steiner point adjacent to more than two other Steiner points (Lemma 3.11). . . . .	24
3.13	Lemma 3.13 . . . . .	25
3.14	Lemma 3.14 . . . . .	25
3.15	The subtree spanning $p_k, p_{k+1}, p_{k+2}, p_{k+3}$ and its bounding box . . . . .	27
3.16	The spanning trees of Berman et al. [4] (a) The bottom tree. (b) The top tree. . . . .	29
3.17	(i) Canonical Steiner tree (ii) Upper pocket $K_i$ (iii) Lower pocket $k_i$ . . . . .	30
3.18	The green tree . . . . .	31

3.19	The red tree . . . . .	32
4.1	Euclidean obstacle-avoiding Steiner ratio for three terminals (a) An OASMT (c) An anchored OASMT. . . . .	35
4.2	Theorem 4.2, a local structure of an OASMT. . . . .	36
4.3	Shifting and flipping in the presence of obstacles . . . . .	39
4.4	The pair of anchored Steiner trees. (a) The green tree. (b) The red tree. The square-shaped dots are the critical corners. . . . .	40
4.5	The green tree . . . . .	41
4.6	The red tree: a) One non-virtual upper critical corner. b) Virtual upper critical corner. c) Two upper critical corners. d) No upper critical corner, non-virtual lower critical corner. e) No upper critical corner, virtual lower critical corner . . . . .	42
4.7	The green and red trees for type (ii) canonical trees. . . . .	43



# Chapter 1

## Introduction

This thesis examines the (geometric) Steiner tree problem: Given a set of points  $P$  in the plane, find a shortest tree interconnecting all points in  $P$ , with the possibility of adding points outside  $P$ , called *Steiner points*, as additional vertices of the tree (see Figure 1.1).

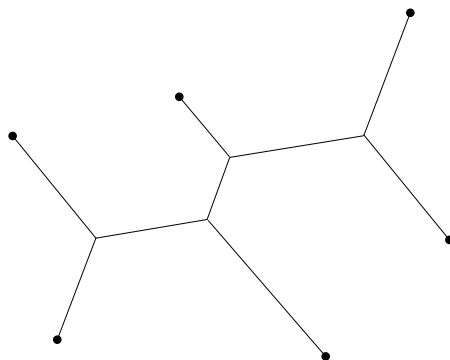

Figure 1.1: A minimum Steiner tree

The Steiner tree problem has wide applications in VLSI design, network routing, wireless design and computational biology [25]. The problem has been studied in different metric spaces such as Euclidean, rectilinear and octilinear metrics. Since the problem is NP-hard in all the aforementioned spaces [18, 19, 32], it is important to study approximation algorithms. The most obvious heuristics for the problem is to approximate a minimum Steiner tree by a minimum spanning tree (a tree that interconnects the points, but uses no Steiner points), which can be found in  $O(n \log n)$  time [29, 35]. The performance ratio of this approximation in various metrics has been subject of extensive research. Gilbert and Pollak [20] defined the *Steiner ratio* as the largest lower bound of the ratio between the lengths of a minimum Steiner tree and a minimum spanning tree. A well-known theorem of Gilbert and Pollak [20] states that the Euclidean Steiner ratio is  $\sqrt{3}/2$ , that is, a minimum spanning tree is never longer than about 1.15 times a minimum Steiner

tree. The Steiner ratio has been researched in different metric spaces. In this thesis, we study the Steiner ratio in Euclidean and rectilinear metrics.

## Our Contribution

The obstacle-avoiding Steiner tree problem is a more realistic modeling of real-world requirements. For example, VLSI routing is often performed in the presence of obstacles, such as logic cells and previously routed nets, that the wires of the net must not intersect.

We study the generalization of the Steiner ratio to the case of obstacles. In order to achieve an approximation factor better than 2, we must add Steiner points to the solution. It seems natural to allow Steiner points at the corners of obstacles. We introduce the concept of an *anchored Steiner tree*: an obstacle-avoiding Steiner tree in which the Steiner points are only allowed at obstacle corners. We then define the *obstacle-avoiding Steiner ratio* as the minimum possible ratio of the length of an obstacle-avoiding minimum Steiner tree to that of an anchored obstacle-avoiding minimum Steiner tree. We prove that, for the rectilinear metric, the obstacle-avoiding Steiner ratio is equal to the traditional (obstacle-free) Steiner ratio. We conjecture that this is also the case for the Euclidean space and we verify this conjecture for three points and any number of obstacles. Finally, we give a constant factor approximation algorithm for the Euclidean obstacle-avoiding Steiner tree problem.

## 1.1 Outline of the Thesis

In the remainder of this chapter, we present the historical background of the Steiner tree problem. In Chapter 2, we study the more recent background on the problem and introduce the basic concepts that we will use throughout this thesis. In Chapter 3, we survey the background literature on the Steiner ratio in the obstacle-free setting. In Chapter 4, we introduce the generalization of the Steiner ratio to the case of obstacles and present our results on Euclidean and rectilinear obstacle-avoiding Steiner ratios. In Chapter 5, we survey the background on polynomial-time approximation schemes for different versions of the Steiner tree problem. Then, we give a constant factor approximation algorithm for the Euclidean obstacle-avoiding Steiner tree problem. We conclude in Chapter 6 with a discussion of future work.

## 1.2 History of the Steiner Tree Problem

The following problem was proposed by Fermat in his paper “Treatises of Maxima and Minima” in the early seventeenth century: Find in the plane a point, the sum of whose distances from three given points is minimal. This problem is referred

to as the *Fermat problem*. A geometric solution was proposed by Torricelli before 1640. His method was to construct equilateral triangles on each side, exterior to the given triangle. He showed that the circles circumscribing the equilateral triangles intersect at the desired point, now called the *Torricelli point* (see Fig. 1.2).

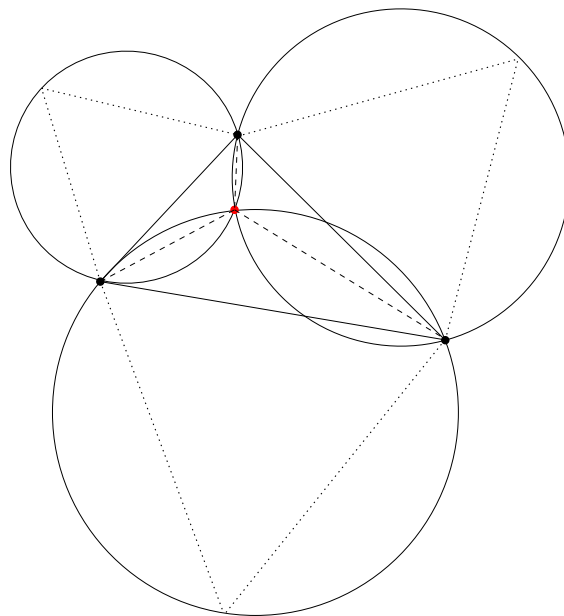

Figure 1.2: Torricelli point.

Cavalieri in his 1647 book “*Exercitationes Geometricas*” showed that the line segments from the three given points to the Torricelli point make  $120^\circ$  angles with each other. When one of the angles in the given triangle is at least  $120^\circ$ , the Torricelli point lies outside the given triangle and is no longer the minimizing point. The minimizing point in this case is the vertex of the obtuse angle. This fact was first observed by Heinen in 1834 and Bertrand in 1853.

A generalization of Fermat’s problem appeared as an exercise in Simpson’s *Doctore and Application of Fluxions* in 1750: Find a point in the plane, the sum of whose distances from  $n$  given points is minimal. This problem is referred to as the *general Fermat problem*.

In 1836, Gauss extended Fermat’s problem even further in a letter to his friend Schumacher. He suggested to find a shortest network, rather than a single point, to interconnect the set of given points. He stated the problem as follows: How can a railway network of minimal length which connects the four German cities of Bremen, Harburg (today a part of Hamburg), Hannover, and Braunschweig be created? Unfortunately, Gauss’s letter was not discovered until 1986. The shortest network problem was first investigated by Jarnik and Kossler in 1934, who raised the following question in [27]: Find a shortest network which interconnects  $n$  points in the plane. In particular, they studied the above problem when the  $n$  points are

the corners of a regular  $n$ -gon. They proved that any  $n - 1$  sides of the  $n$ -gon is a shortest network for  $n \geq 13$ .

The problem was popularized under the name of the *Steiner problem* in the book *What is Mathematics* by Courant and Robbins [12] in 1941. But actually, Steiner had not contribute to this problem, but rather to the general Fermat problem. Nevertheless, the misnomer has been perpetuated by the continual popularity of the book of Courant and Robbins.

In 1961, Melzak [30] developed the first finite algorithm to solve the Steiner problem. Gilbert and Pollak [20] published a thorough survey on the Steiner problem in 1968 and introduced the name *minimum Steiner tree* (SMT) for the shortest interconnecting network, and *Steiner points* for vertices in an SMT which are not among the  $n$  original points. They raised many new topics including the *Steiner ratio* problem, and extended the problem to other metric spaces. They also studied a probabilistic version of the problem.

Since then, there has been a lot of research on the Steiner tree problem. For an excellent survey on related work before 1992, one may refer to the book by Hwang et al. [25], which is the source of this section's material.

# Chapter 2

## Background on the Steiner Tree Problem

This chapter introduces the basic concepts used in the rest of the thesis, and gives some brief background on the Steiner tree problem.

Given a set  $P$  of points in the plane, the (*geometric*) *Steiner tree problem* is to find a shortest tree that interconnects all points in  $P$ . Such a shortest tree is called a *minimum Steiner tree (SMT)*, for the given set of points. An SMT for a point set  $P$  may contain vertices not in  $P$ . Such vertices are called *Steiner points*, while vertices in  $P$  are called *terminals* (see Figure 1.1).

The Steiner tree problem has been studied in different metric spaces, the most heavily studied of which are Euclidean and rectilinear metrics. We discuss the Euclidean Steiner tree problem in Section 2.1, and the rectilinear Steiner tree problem in Section 2.2.

### 2.1 The Euclidean Steiner Tree Problem

First, we review some basic properties of a Euclidean minimum Steiner tree (ESMT or simply SMT).

If two edges  $ab$  and  $bc$  of a tree meet at an angle less than  $120^\circ$ , then one can shorten the tree by replacing  $ab$  and  $bc$  with the solution of the Fermat problem for  $\{a, b, c\}$  (see Section 1.2). Therefore, any two edges in an SMT must meet at an angle of at least  $120^\circ$ . As an immediate result, every vertex has degree at most three, a Steiner point has degree exactly three and every angle at a Steiner point is  $120^\circ$ . An SMT for  $n$  terminals can contain at most  $n - 2$  Steiner points [12].

A Steiner tree in which all terminals are leaves is called a *full* Steiner tree. An SMT contains exactly  $n - 2$  Steiner points if and only if it is full. If a terminal is not a leaf, we can split the Steiner tree at this terminal. In this way, any Steiner tree can be decomposed into edge-disjoint full Steiner subtrees. Such full Steiner subtrees are called *full components* of the Steiner tree.

### 2.1.1 Complexity

The Euclidean Steiner tree problem (ESP) can be formulated as a decision problem as follows:

- **Given:** A set  $P$  of terminals in the Euclidean plane and a real number  $k$ .
- **Decide:** Is there a tree  $T$  that interconnects all terminals in  $P$  such that the total length of  $T$  is less than or equal to  $k$ ?

Currently, the Euclidean Steiner decision problem is not known to be in  $NP$ , and may not be, due to the numerical difficulties involving the computation of irrational numbers on finite-precision machines. Thus another related, perhaps simpler, problem has been proposed known as the *discrete Euclidean Steiner problem* (DESP):

- **Given:** A set  $P$  of terminals with integer coordinates in the Euclidean plane and an integer  $k$ .
- **Decide:** Is there a tree  $T$  that interconnects all terminals in  $P$  such that all Steiner points have integer coordinates and the *discrete length* of  $T$  is less than or equal to  $k$ ?

The *discrete length* of an edge is defined as the smallest integer not less than the length of that edge. The discrete length of a tree is the sum of discrete lengths of its edges. The discrete Euclidean Steiner problem is in NP, since it is easy to verify that a tree has discrete length bounded by an integer. Garey, Graham and Johnson [18] proved that DESP is NP-complete, by a reduction from the NP-complete problem known as the *exact cover by 3-sets*.<sup>1</sup>

Returning to the original Euclidean Steiner decision problem, any polynomial algorithm that solves ESP can also solve DESP. Thus, ESP is NP-hard [18].

### 2.1.2 Exact Algorithms

Melzak [30] proposed the first finite algorithm for the Euclidean Steiner tree problem. The *topology* of a Steiner tree is defined as its graph structure, i.e. it includes the terminals and the Steiner points as the vertices and specifies the connection between these vertices as edges. However, the topology does not include the geometric embedding in the plane and the edge lengths. Melzak's approach is to find a minimal Steiner tree for every possible topology  $\mathcal{G}$  on  $P$ , and select the shortest among these trees as the solution to SMT problem. The algorithm first partitions

---

<sup>1</sup>Given a set  $X$  and a family  $C$  of subsets of size three of  $X$ , the *exact cover by 3-sets* problem asks if it is possible to select some mutually disjoint subsets from  $C$  such that their union is  $X$ .

a topology  $\mathcal{G}$  into subgraphs  $\mathcal{G}_i$ , such that each  $\mathcal{G}_i$  is a full topology. Then the full Steiner tree (FST) for each  $\mathcal{G}_i$  is constructed by the FST subroutine, and FSTs are joined to get a minimal tree of topology  $\mathcal{G}$ . If for some  $\mathcal{G}_i$  the FST does not exist, then no minimal trees relative to  $\mathcal{G}$  exists. The algorithm iterates over all possible topologies and stores the trees. A shortest one of the stored trees is then selected as an SMT.

The FST subroutine can be implemented in  $O(n)$  time on a real RAM model of computation. The major inefficiency of the Melzak’s algorithm comes from the superexponential number of topologies that need to be considered. Ajtai et. al. [1], Smith [43] and Hayward [23] have proposed methods to cut down the number of considered topologies to an exponential number.

Among other exact algorithms for the Euclidean Steiner problem are the *GeoSteiner* algorithm by Winter [45], the *negative edge* algorithm by Trietsch and Hwang [44] and the *luminary* algorithm by Hwang and Weng [26].

## 2.2 The Rectilinear Steiner Tree Problem

The rectilinear Steiner tree problem was first considered by Hanan [22] in 1966. It is defined as the problem of finding a shortest tree interconnecting a set of given points where the distance is measured in  $L_1$  (or rectilinear) metric. Such a shortest tree is called a *rectilinear minimum Steiner tree (RSMT)*. The distance between the points  $a : (x_1, y_1)$  and  $b : (x_2, y_2)$  in  $L_1$  (rectilinear) metric is defined as

$$|ab| = |x_1 - x_2| + |y_1 - y_2|$$

Equivalently, to solve the rectilinear Steiner tree problem, we need to connect the terminals by a Steiner tree in which every edge is a path of horizontal and vertical segments. Points along such an edge where two segments meet are called *corner points*, and the two segments incident to a corner point are called the *legs* of the corner. A Steiner point is a point that has degree at least three and is not a terminal.

Garey and Johnson [19] proved that the rectilinear Steiner tree problem is *NP*-complete by reducing from the *NP*-complete problem known as the *connected vertex cover in planar graphs with maximum degree 4*.

### 2.2.1 Transformation to Steiner Problem in Graphs

The rectilinear Steiner tree problem can be reduced to the *graph Steiner tree problem (GST)*, which is a combinatorial version of the geometric Steiner tree problem and is defined as follows: Given an undirected weighted graph  $G = (V, E)$  and a

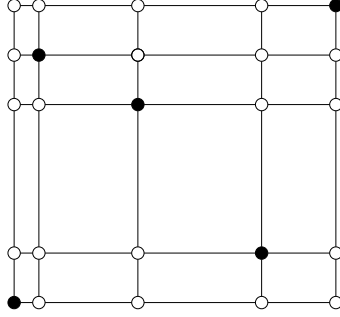

Figure 2.1: Hanan grid graph for a set of 5 terminals.

subset  $N \subseteq V$  of vertices, find a minimum weight subtree of  $G$  that includes all vertices in  $N$ .

The following theorem by Hanan states that the Steiner points of an RSMT can be restricted to a set of  $O(n^2)$  points:

**Theorem 2.1** (Hanan [22]). *For every set of terminals, there exists a rectilinear minimum Steiner tree in which every Steiner point shares its  $x$  and  $y$  coordinates with some pair of terminals.*

Given a set of points, the *Hanan grid* of the points can be created by passing a horizontal and a vertical line through each point. Theorem 2.1 implies that the *Hanan grid graph* always contains an RSMT. The vertices of the Hanan grid graph are the intersections of the Hanan grid lines. There is an edge between two vertices if they are adjacent along a grid line, and the weight of an edge is the rectilinear distance between its endpoints (see Figure 2.1).

An optimal solution to the graph Steiner tree problem on a Hanan grid graph is an optimal solution to the rectilinear Steiner tree problem from which it was constructed. As a result, approximation algorithms for the graph Steiner tree problem produce equivalent approximations for the rectilinear Steiner tree problem.

## 2.3 The Obstacle-Avoiding Euclidean Steiner Tree Problem

Given a set  $P$  of  $n$  terminals and a set  $O$  of  $m$  disjoint obstacles, the *obstacle-avoiding Euclidean Steiner tree (OAEST)* problem is to find a shortest tree interconnecting all points in  $P$  and avoiding the interior of the obstacles in  $O$ . Such a tree is called an *obstacle-avoiding minimum Steiner tree (OASMT)*. We denote an instance of the problem as  $I = (P, O)$ , and the size of the instance is  $n = |P| + \sum_{o \in O} |o|$ , where  $|o|$  is the number of vertices of the obstacle  $o$ .



An *obstacle* is a connected region in the plane bounded by a polygon such that no two polygon edges have an inner point in common. The terminals are permitted to be on the boundaries of the obstacles, but not in the interior of them.

The angles at a Steiner point that does not lie on an obstacle boundary are  $120^\circ$ , as in the case without obstacles. To see why, note that there exists three points, each on an edge incident to the Steiner point, such that the triangle formed by the points does not contain any obstacle. The part of the OASMT inside this triangle must be a minimum Steiner tree of the three points, and since there are no obstacles to avoid, the angles at the Steiner point must be  $120^\circ$ . As a result, a Steiner point not on an obstacle boundary has degree three. The above argument does not apply if the Steiner point is on an obstacle boundary. In this case, the  $120^\circ$  condition does not necessarily hold. Such a Steiner point may have degree two, in which case we call it a *degenerate Steiner point*. An Steiner point on an obstacle boundary is located at a corner of the obstacle, for otherwise we can move the Steiner point slightly away from the obstacle so that it gets closer to all terminals connected to it, and thus reduce the length of the Steiner tree.

A *full* obstacle-avoiding Steiner tree is defined as a Steiner tree in which all terminals and obstacle corners appear only as leaves of the tree. Any obstacle-avoiding Steiner tree can be decomposed into edge-disjoint full components. Such decompositions are used in proofs of Steiner ratio results. We note that when a Steiner tree is decomposed by cutting at an obstacle corner contained in the tree, the obstacle corner must be added as a terminal in each of the two subproblems.

The Euclidean Steiner tree problem is NP-hard [18], and therefore the obstacle-avoiding Euclidean Steiner tree problem is as well. The first exact algorithm for the problem is given by Zachariassen and Winter [46].

## 2.4 The Obstacle-Avoiding Rectilinear Steiner Tree Problem

If every boundary edge of an obstacle is either horizontal or vertical, we call it a *rectilinear obstacle*. The *obstacle-avoiding rectilinear Steiner tree (OARST)* problem is identical to the OAEEST problem except that the distances are measured in the  $L_1$  metric and the obstacles are rectilinear. An optimal solution to the OARST problem is called an *obstacle-avoiding rectilinear minimum Steiner tree (OARSMT)*.

Steiner points can have degree three or four, and both Steiner points and corner points can occur on obstacle boundaries but only at vertices of obstacles. The full components are defined as for the Euclidean case.

The rectilinear Steiner tree problem is NP-complete [19], and therefore the obstacle-avoiding rectilinear Steiner tree problems is as well.

### 2.4.1 Reduction to the Graph Steiner Tree problem

For the obstacle-free problem, Hanan [22] showed that a Hanan grid graph always contains an RSMT (Theorem 2.1). Ganley and Cohoon [17] generalize Hanan's result to the obstacle-avoiding case, by showing that the following graph, called the *escape graph*, is guaranteed to contain an OARSMT. Draw horizontal and vertical lines through each terminal until they hit the obstacles. Then, extend each obstacle perimeter segment, again until it hits the obstacles. The segments resulting from this construction are called the *escape segments*. The vertices of the escape graph are the intersections of the escape segments and there is an edge between every pair of vertices that is adjacent along an escape segment. If there are no obstacles, the Hanan grid graph and escape graph are equivalent.

**Theorem 2.2** (Ganley and Cohoon [17]). *For any set of terminals  $P$  and obstacles  $O$ , if the obstacle-avoiding Steiner tree problem has a solution, then there exists an obstacle-avoiding minimum Steiner tree that is a subgraph of the escape graph of  $P$  and  $O$ .*

Theorem 2.2 implies that approximation algorithms for the graph Steiner tree problem produce equivalent approximations for the obstacle-avoiding rectilinear Steiner tree problem.

# Chapter 3

## The Steiner Ratio

Since the Steiner tree problem is NP-hard in Euclidean and rectilinear spaces [18, 19], it is important to study approximation algorithms for the problem. The difficulty of the Steiner tree problem lies in the large number of possible positions for the Steiner points. However, if Steiner points are not allowed, the problem becomes the minimum spanning tree (MST) problem, which is solvable in  $O(n \log n)$  time [29, 35]. The question is: How good is the quality of a minimum spanning tree as an approximation for a minimum Steiner tree?

Gilbert and Pollak [20] defined the *Steiner ratio* (denoted by  $\rho$ ) to be the largest lower bound, over all sets of terminals  $P$ , of the ratio between the length of a minimum Steiner tree and that of a minimum spanning tree:

$$\rho = \inf_P \frac{|SMT(P)|}{|MST(P)|}$$

where  $MST(P)$  and  $SMT(P)$  stand for a minimum spanning tree and a minimum Steiner tree of  $P$ , respectively.

In this chapter, we survey the background literature on the Steiner ratio in Euclidean space (Section 3.1) and rectilinear space (Section 3.2). We present a new proof for the rectilinear Steiner ratio theorem (Theorem 3.5) [24] in Section 3.2.4.

## 3.1 The Euclidean Steiner Ratio

Consider the set of three points  $P = \{A, B, C\}$  forming an equilateral triangle with unit edge length. A minimum Steiner tree for  $P$  has length  $\sqrt{3}$ , and a minimum spanning tree for  $P$  has length 2 (see Figure 3.1). So,  $|SMT(P)|/|MST(P)| = \sqrt{3}/2 \approx 0.866$ .

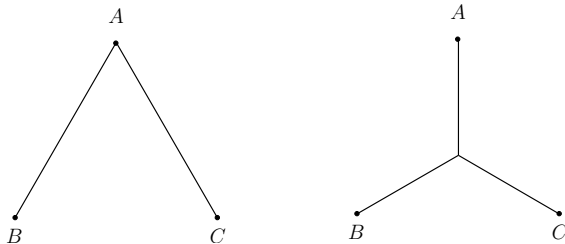

Figure 3.1: An MST and an SMT for three corners of an equilateral triangle.

Gilbert and Pollack [20] proved that this bound holds for any three points in general position (see Section 3.1.1). Furthermore, they conjectured that the Euclidean Steiner ratio is  $\sqrt{3}/2$ , that is, the  $\sqrt{3}/2$  bound holds for any number of points.

Gilbert and Pollack's conjecture was verified by Pollak [34] for  $n = 4$ , by Du, Hwang and Yao [16] for  $n = 5$  and by Rubinstein and Thomas [40] for  $n = 6$ .

Along another line of research, the lower bound of 0.57 for general  $n$  was proved by Graham and Hwang [21], which was improved to 0.74 by Chung and Hwang [10], to 0.8 by Du and Hwang [14] and to 0.824 by Chung and Graham [9], who enlisted the help of the symbolic computation system MAXIMA.

The conjecture was finally proved by Du and Hwang [15]. In both results for the small  $n$  and the lower bounds for general  $n$ , the lack of further progress was caused by the overwhelming amount of computation involved in the proofs. The proof of Du and Hwang, on the other hand, is conceptual and requires essentially no computation.

### 3.1.1 Euclidean Steiner Ratio for $n = 3$

Gilbert and Pollak [20] gave the following proof for the Steiner ratio for three points.

Let  $a, b$  and  $c$  be three terminals with an SMT  $\mathcal{T}$  and a minimum spanning tree  $\mathcal{M}$ . If  $\mathcal{T}$  has no Steiner point, then  $\mathcal{T} = \mathcal{M}$  and the conjecture is trivially true. Otherwise, let  $s$  be the only Steiner point of  $\mathcal{T}$ . Without loss of generality, assume that  $|sa| \leq |sb|$  and  $|sa| \leq |sc|$ . Let  $b'$  and  $c'$  be points on  $sb$  and  $sc$ , respectively, such that  $|sb'| = |sc'| = |sa|$  (see Figure 3.2).

Note that  $\triangle ab'c'$  is an equilateral triangle and we have

$$\begin{aligned}
 |\mathcal{T}| &= |sa| + |sb'| + |sc'| + |b'b| + |c'c| \\
 &= \frac{\sqrt{3}}{2}(|ab'| + |ac'|) + |b'b| + |c'c| \\
 &\geq \frac{\sqrt{3}}{2}(|ab'| + |b'b| + |ac'| + |c'c|) \\
 &\geq \frac{\sqrt{3}}{2}(|ab| + |ac|) \\
 &\geq \frac{\sqrt{3}}{2}|\mathcal{M}|
 \end{aligned}$$

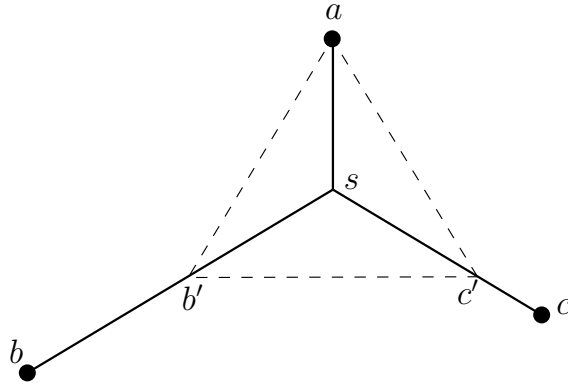

Figure 3.2: A minimum Steiner tree for three points.

### 3.1.2 Euclidean Steiner Ratio Proof by Du and Hwang

In this section, we summarize the Euclidean Steiner ratio proof of Du and Hwang [15]. Our original motivation for going through the proof was to extend it to the case of obstacles. In chapter 6, we comment on the possibility of this, but it was a goal that proved too difficult. Lemma 3.1 is the only part of this section that is needed for the rest of this thesis.

Very recently, we learned of a 2008 PhD thesis in which the correctness of Du and Hwang’s proof has been brought into question [13]. We have not had time to assess that work.

First, we state a lemma which is used in the proofs of the Steiner ratios theorems in Euclidean and rectilinear metrics and in the obstacle-avoiding case..

**Lemma 3.1.** *For a set of terminals  $P$ , let  $\mathcal{T}$  be a minimum Steiner tree which is not full. If for every full component  $\mathcal{F}_i$  of  $\mathcal{T}$  there exists a minimum spanning*

tree  $\mathcal{M}_i$  such that  $|\mathcal{M}_i| \leq c|\mathcal{F}_i|$  for some constant  $c$ , then there exists a minimum spanning tree  $\mathcal{M}$  for  $P$  such that  $|\mathcal{M}| \leq c|\mathcal{T}|$ .

*Proof.* The union of all  $\mathcal{M}_i$ 's is a spanning tree (not necessarily a minimum spanning tree) for  $P$  and so we have

$$|\mathcal{M}| \leq \sum_i |\mathcal{M}_i| \leq \sum_i c|\mathcal{F}_i| = c|\mathcal{T}|.$$

□

In proving a Steiner ratio theorem, if a terminal set has a minimum Steiner tree which is not full, we break that tree into full components. We repeat this process recursively for the subsets of terminals until no further decomposition is possible. The result is subsets of terminals for each of which every minimum Steiner tree is full. If the Steiner ratio theorem holds for such terminal sets, we can combine as in Lemma 3.1 to prove the theorem for the original terminal set. Therefore, it suffices to prove the Steiner ratio theorems for terminal sets for which every minimum Steiner tree is full. This holds for both Euclidean and rectilinear metrics and also for the obstacle-avoiding case.

**Theorem 3.1** (Du and Hwang [15]). *For any terminal set  $P$  in the Euclidean plane, let  $\mathcal{T}$  and  $\mathcal{M}$  be a minimum Steiner tree and a minimum spanning tree for  $P$ , respectively. Then,*

$$\rho(P) = \frac{|\mathcal{T}|}{|\mathcal{M}|} \geq \frac{\sqrt{3}}{2}$$

From Lemma 3.1, it suffices to prove the Steiner ratio theorem for full Steiner trees. The *topology* of a Steiner tree refers to its graph structure, i.e., it includes the terminals and the Steiner points as vertices and the connection between these vertices as edges. However the topology does not contain the geometric embedding in the plane and the edge lengths. A full Steiner tree on  $n$  terminals has  $2n - 3$  edges and can be determined, up to rotation and translation, by its topology and  $2n - 3$  edge lengths. Without loss of generality, we may normalize the length of the Steiner tree to be 1. Let  $x$  denote a vector of  $2n - 3$  non-negative numbers summing to 1. Denote by  $\mathcal{F}(\tau, x)$  the full Steiner tree with topology  $\tau$  and edge-length vector  $x$ . Let  $\mathcal{P}(\tau, x)$  denote the set of terminals of  $\mathcal{F}(\tau, x)$ . For a spanning tree topology  $s$ , let  $\mathcal{S}(s, \tau, x)$  denote the spanning tree with topology  $s$ , spanning over the terminal set of  $\mathcal{P}(\tau, x)$ . Let  $\mathcal{I}$  and  $X$  denote the set of spanning tree topologies, and the set of edge length vectors, respectively.

Theorem 3.1 can be rewritten as follows: for any full topology  $\tau$  and edge-length vector  $x$ , if  $\mathcal{F}(\tau, x)$  exists then

$$|\mathcal{F}(\tau, x)| \geq (\sqrt{3}/2) \min_{s \in \mathcal{I}} |\mathcal{S}(s, \tau, x)|. \tag{3.1}$$

Let  $f_{s,\tau}(x) = |\mathcal{F}(\tau, x)| - (\sqrt{3}/2)|\mathcal{S}(s, \tau, x)| = 1 - (\sqrt{3}/2)|\mathcal{S}(s, \tau, x)|$ . Now (3.1) can be rewritten as the following minmax problem:

$$\min_{x \in X} \max_{s \in \mathcal{I}} f_{s,\tau}(x) \geq 0 \quad (3.2)$$

The Euclidean distance function is a convex function. Therefore,  $|\mathcal{S}(s, \tau, x)|$  and  $f_{s,\tau}(x)$  are convex and concave functions with respect to  $x$ , respectively. The Steiner ratio problem is now transformed to a minimax problem on a family of concave functions. Du and Hwang [15] proved Theorem 3.2 regarding such minimax problems.

Before stating the theorem, we define *critical points* of a polytope. A subset  $Y$  of a polytope  $X$  is called *extreme* if each segment  $[x, y] \in X$  intersecting with  $Y$  at some inner point lies entirely in  $Y$ . For any  $x \in X$ , define  $\mathcal{I}(x)$  as the set of indices  $i \in \mathcal{I}$  such that  $g(x) = f_i(x)$ . Consider an extreme set  $Y \subseteq X$  and a point  $x$  in  $Y$ . The point  $x$  is called a *critical point* if the set  $\mathcal{I}(x)$  is maximal by inclusion among all sets  $\mathcal{I}(y)$ ,  $y \in Y$ . This means that if for some point  $y \in Y$ ,  $\mathcal{I}(x) \subseteq \mathcal{I}(y)$  then  $\mathcal{I}(x) = \mathcal{I}(y)$ .

**Theorem 3.2.** *Suppose  $g(x) = \max_{i \in \mathcal{I}} f_i(x)$  where  $\mathcal{I}$  is finite and every  $f_i(x)$  is a continuous and concave function. Then the minimum value of  $g(x)$  over some polytope  $X$  is achieved at finitely many special points, namely the critical points.*

Translating back to the original Steiner ratio problem, a critical point in  $X$  corresponds to a terminal set with maximum number of minimum spanning trees. By Theorem 3.2, it suffices to prove the Steiner ratio theorem for these critical terminal sets. However, it is not easy to determine the structure of such terminal sets. In the following, the concept of the *minimum inner spanning trees* is introduced. We will see that a terminal set with maximum number of minimum inner spanning trees has a very specific structure.

## Inner Spanning Trees

Consider a full Steiner tree  $\mathcal{T}$ . Let  $v_1 \dots v_k$  be a path in  $\mathcal{T}$ . The path is said to be *convex* if it contains only one or two segments or if for every  $i = 1, \dots, k-3$ , the segment  $v_i v_{i+3}$  does not cross the piece  $v_i v_{i+1} v_{i+2} v_{i+3}$  of the path. Two terminals are said to be *adjacent* if they are connected by a convex path in  $\mathcal{T}$ . Connect every pair of adjacent terminals in  $\mathcal{T}$  to obtain a polygon that bounds an area containing  $\mathcal{T}$ . This area is called the *characteristic area* of  $\mathcal{T}$  and is denoted by  $\mathcal{C}(\tau, x)$  (See Figure 3.3). An *inner spanning tree* of  $\mathcal{T}$  is a spanning tree that lies inside the characteristic area.

The Steiner ratio theorem is a corollary of the following theorem:

**Theorem 3.3.** *For every minimum Steiner tree  $\mathcal{T}$ , there exists an inner spanning tree  $\mathcal{N}$  such that*

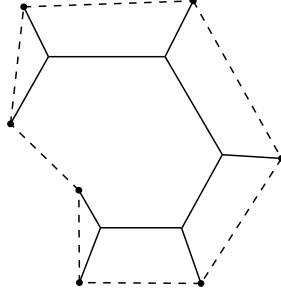

Figure 3.3: Characteristic area.

$$\frac{|\mathcal{T}|}{|\mathcal{N}|} \geq \frac{\sqrt{3}}{2}. \quad (3.3)$$

Theorem 3.3 can be formulated as the following minimax problem:

$$\min_{x \in X} \max_{s \in \mathcal{I}(\tau, x)} f_{\tau, s}(x) \geq 0$$

in which  $\mathcal{I}(\tau, x)$  is the set of all inner spanning tree topologies for  $\mathcal{P}(\tau, x)$ . A critical point is now a point set with a maximum number of minimum *inner* spanning trees. Next, we determine the structure of these critical point sets.

Denote by  $\Gamma(\tau, x)$  the graph formed by the union of minimum inner spanning trees of  $\mathcal{P}(\tau, x)$ . The following two lemmas help us to characterize the structure of  $\Gamma(\tau, x)$ . They are variations of the lemmas for minimum spanning trees given by Rubinstein and Thomas [41].

**Lemma 3.2.** *Two inner minimum spanning trees can never cross.*

From Lemma 3.2,  $\Gamma(\tau, x)$  partitions the characteristic area into smaller areas, each of which is bounded by a polygon with vertices that are all terminals.

**Lemma 3.3.** *Every polygon of  $\Gamma(\tau, x)$  has at least two equal longest edges.*

Furthermore, each polygon is an equilateral triangle in the case of a critical point set:

**Lemma 3.4.** *Let  $\mathcal{P}(\tau^*, x^*)$  be a critical point set. Then  $\Gamma(\tau^*, x^*)$  partitions the characteristic area into  $n - 2$  equilateral triangles.*

We omit the proof, but note that it uses the fact that the edge lengths of  $\Gamma(\tau^*, x^*)$  are independent variables, that is, the network could vary by changing any edge length and fixing all others. This is not necessarily true in case of unconstrained minimum spanning trees, and thus the concept of minimum *inner* spanning trees is crucial to the proof.



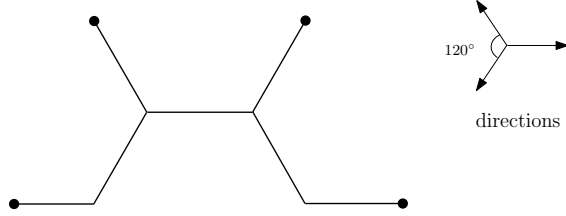

Figure 3.4: A hexagonal tree.

From Lemma 3.4, a critical point set can be placed on a lattice of equilateral triangles, which we call a *critical lattice*. Let  $a$  be the length of an edge of each triangle in the critical lattice. It follows that

**Lemma 3.5.** *A minimum inner spanning tree of  $\mathcal{P}(\tau^*, x^*)$  has length  $(n - 1)a$ .*

It remains to verify the truth of the Steiner ratio theorem for  $n$  points on an equilateral triangular lattice.

### Minimum Hexagonal Trees

Given a set of terminals and three directions each two of which meet at an angle of  $120^\circ$ , a *minimum hexagonal tree* is a shortest tree interconnecting the terminals such that all edges are parallel to the three directions (Figure 3.4). A minimum hexagonal tree is longer than or equal to a minimum Steiner tree, however it cannot be longer than  $2/\sqrt{3}$  times.

**Lemma 3.6.** *For any terminal set  $P$ , the length of a minimum hexagonal tree is at most  $2/\sqrt{3}$  times the length of a minimum Steiner tree.*

*Proof.* Each edge of a minimum Steiner tree can be replaced by two equal edges meeting at  $120^\circ$  and parallel to the given directions. It is easy to see that the total length of such two edges is equal to  $2\sqrt{3}$  times the length of Steiner tree's edge. Therefore there exists a hexagonal tree which is  $2/\sqrt{3}$  times longer than the minimum Steiner tree.  $\square$

Now, let the three directions be parallel to the edges of the equilateral triangles in the critical lattice.

**Lemma 3.7.** *For any set of  $n$  lattice points, there is a minimum hexagonal tree whose vertices are all lattice points.*

We omit the proof.

A minimum hexagonal tree for  $n$  points has at least  $n - 1$  edges, each of which is longer or equal to an edge of a triangle in the lattice by Lemma 3.7. Therefore,

a minimum hexagonal tree is of length at least  $(n - 1)a$ , the length of a minimum spanning tree. Note that a minimum spanning tree of the critical terminal set is a hexagonal tree, so it is also a minimum hexagonal tree. By Lemma 3.6, we have

$$|\mathcal{T}(\tau^*, x^*)| \geq \frac{\sqrt{3}}{2} |\mathcal{S}(s, \tau^*, x^*)|.$$

Theorem 3.1 is proved.

## 3.2 The Rectilinear Steiner Ratio

In this section, we consider the Steiner ratio for the rectilinear metric. A *rectilinear minimum spanning tree* (RMST) is a shortest tree spanning a given terminal set where the distance is measured in  $L_1$  metric. Let  $\mathcal{T}(P)$  and  $\mathcal{M}(P)$  be a rectilinear minimum Steiner tree and a rectilinear minimum spanning tree for a set of terminals  $P$ , respectively. The rectilinear Steiner ratio, denoted by  $\rho$ , is defined as

$$\rho = \inf_P \frac{|\mathcal{T}(P)|}{|\mathcal{M}(P)|}$$

We will not indicate the metrics when using the notation  $\rho$ , but it will be always clear from the context. Hwang [24] proved that  $\rho = 2/3$ . Figure 3.5 shows a rectilinear minimum Steiner tree and a rectilinear minimum spanning tree for terminals  $\{(0, 1), (1, 0), (0, -1), (-1, 0)\}$ . The length of the minimum Steiner tree is 4 and the length of the minimum spanning tree is 6. It follows that  $\rho$  is at most  $2/3$ , and it remains to prove that it does not drop below this value.

Hwang's proof has two main steps: In the first step, he identifies a general structure for the rectilinear minimum Steiner trees. We summarize this step of Hwang's proof in Section 3.2.1. In the second step, using the characterization result of step one, he shows that there always exists a short spanning tree that satisfies the  $2/3$  bound. Two alternative proofs for the second step of Hwang's proof are given by Salowe [42] and Berman et. al. [4]. In Section 3.2.2, we present Salowe's proof [42], which proceeds in the same fashion of that of Hwang but is more illuminating. We briefly review the proof of Berman et al. [4] in section 3.2.3.

We give a new proof for the rectilinear Steiner ratio in Section 3.2.4, which is inspired by the proof of Berman et al. [4] and uses the characterization result of Hwang [24]. In Chapter 4, Section 4.2, we will generalize this proof to the case of obstacles. The following parts of this chapter are required for Chapter 4: the definitions of canonical trees, shift and flip operations and Theorem 3.4 in Section 3.2.1 and the terminology regarding canonical trees in Section 3.2.4.

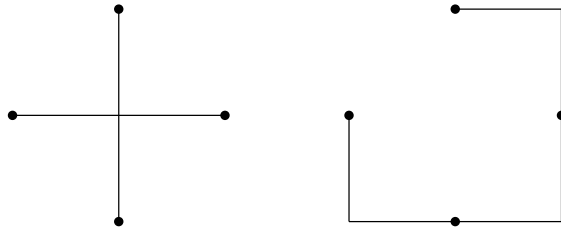

Figure 3.5: A minimum Steiner tree and a minimum spanning tree with length ratio of  $2/3$ .

### 3.2.1 Canonical Trees

As in the Euclidean case (see Lemma 3.1), if a terminal set has a minimum Steiner tree that is not full, then we can decompose it into full components. Thus it suffices to consider terminal sets for which every minimum Steiner tree is full. The first step in Hwang's proof is to show that any such terminal set has a *canonical tree*. A rectilinear Steiner tree is *canonical*, if it has one of the shapes shown in Figure 3.6, possibly after reflection and/or rotation. The formal definition follows.

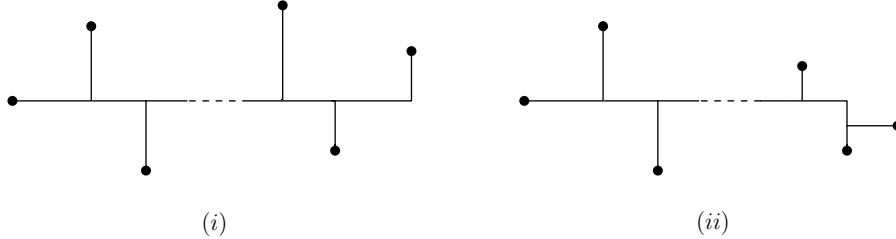

Figure 3.6: Canonical Steiner trees

**Definition 3.1** (Canonical Trees). *A rectilinear Steiner tree  $T$  is canonical, if every terminal in  $T$  has degree one and one of the following conditions is satisfied, possibly after reflection and/or rotation:*

- i. The Steiner points form a horizontal chain. Each one is connected to a terminal by a vertical edge and the vertical edges alternately extend up and down. The leftmost Steiner point is connected to a terminal by a horizontal edge. The rightmost Steiner point is connected by a horizontal edge to a terminal or a corner, and in the latter case, the vertical leg of the corner continues the alternating pattern of the vertical edges to terminals (see Figure 3.6 (i)).*
- ii. As case [i] with a corner at the right, but with the addition of one extra terminal on the far right joined by a horizontal edge to one extra Steiner point on the rightmost vertical segment (see Figure 3.6 (ii)).*

The horizontal line connecting all or all but one of the Steiner points is called the *spine* of the Steiner tree. The vertical segments which connect the terminals to the Steiner points are called the *ribs*.

Now, we state the main result of this section.

**Theorem 3.4** (Hwang [24]). *Let  $P$  be a terminal set such that every rectilinear minimum Steiner tree for  $P$  is full. Then, there exists a rectilinear minimum Steiner tree for  $P$  that is either a canonical tree or has one of the shapes in Figure 3.7, possibly after reflection and/or rotation:*

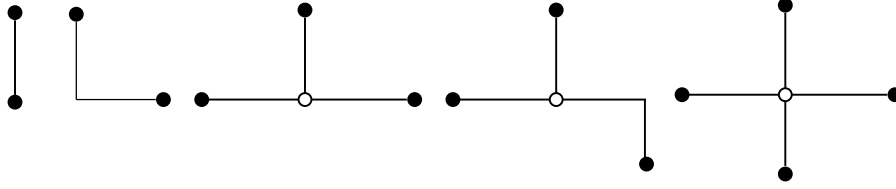

Figure 3.7: minimum Steiner trees with less than 5 terminals

**Corollary 3.1.** *For every terminal set  $P$ , there exist a rectilinear minimum Steiner tree in which every full component either has one of the shapes in Figure 3.7 or is a canonical tree, possibly after reflection and/or rotation.*

Before we prove the theorem, we define two operations on rectilinear Steiner trees that are used in the proof: *shift* and *flip*. In a shift, a segment incident to two parallel segments is replaced by another segment also incident to the parallel segments (see Figure 3.8 (a)). In a flip, two segments meeting at a corner and forming adjacent sides of a rectangle are replaced by the opposite sides (see Figure 3.8 (b)). Recall that by definition, a segment does not contain any vertex in its interior, and thus no vertex is moved in shifts and flips. A Steiner tree maintains its connectivity and spanning properties after shifts and flips are applied, and also the length of the tree is not increased. Therefore, after applying shifts and flips to an RSMT, the resulting tree is still an RSMT. Two Steiner trees are said to be *equivalent*, if one can be obtained from the other one through a series of shifts and flips.

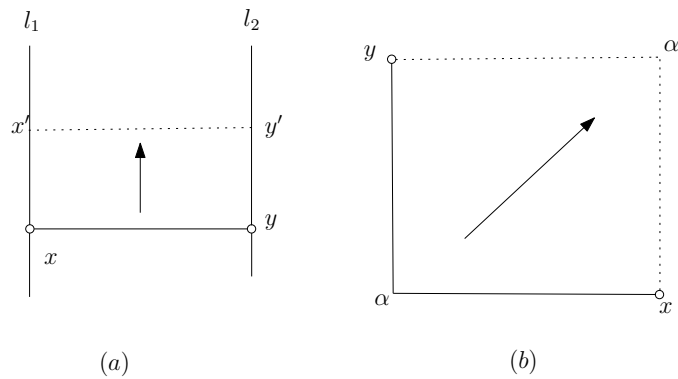

Figure 3.8: (a) Shift (b) Flip

We are ready to begin the proof now. We note again that this exposition follows Hwang's proof.

*Proof.* Let  $\mathcal{F}$  be an RSMT for  $P$ . The following lemmas specify several properties of  $\mathcal{F}$ . We prove only a sample of these lemmas.

Any edge consisting of more than two segments can be changed to one with at most two segments by a series of shifts and flips. From now on, we assume that every edge consists of at most two segments. In the figures of this section, the terminals are represented by filled circles, and the Steiner points are represented by open circles.

**Lemma 3.8.** *Consider a path of segments in  $\mathcal{F}$ , lying on a line and going from point  $\alpha$  to point  $\beta$ . Suppose that there exist segments  $l_1$  and  $l_2$  incident to  $\alpha$  and  $\beta$ , respectively, perpendicular to and on the same side of  $\alpha\beta$ . Then  $\alpha\beta$  contains at least two Steiner points (see Figure 3.9).*

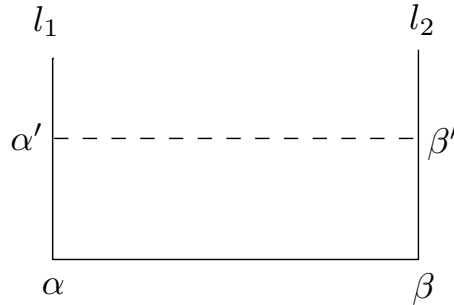

Figure 3.9: Lemma 3.8

*Proof.* Let  $\alpha'$  and  $\beta'$  be points on  $l_1$  and  $l_2$  such that  $|\alpha\alpha'| = |\beta\beta'|$ , and no Steiner point exists in the interior of  $\alpha\alpha'$  or  $\beta\beta'$ . If  $\alpha\beta$  contains no Steiner point, we can flip  $\alpha$  between  $\beta$  and  $\alpha'$  to cause overlapping with  $\beta\beta'$  and save in the length of  $\mathcal{F}$ , a contradiction to optimality of  $\mathcal{F}$ . If  $\alpha$  [ $\beta$ ] is a Steiner point and  $\alpha\beta$  contains no other Steiner point, we can flip  $\beta$  [ $\alpha$ ] between  $\alpha$  [ $\beta$ ] and  $\beta'$  [ $\alpha'$ ] to cause overlapping and save in the length of  $\mathcal{F}$ , a contradiction to optimality of  $\mathcal{F}$ . The only remaining case is where  $\alpha\beta$  contains only one Steiner point  $u$  which is neither  $\alpha$  nor  $\beta$ . This case can be transformed to the previous case by flipping  $\alpha$  between  $u$  and  $\alpha'$ , which also leads to a contradiction. □

**Lemma 3.9.** *No Steiner point in  $\mathcal{F}$  is adjacent to more than one corner.*

*Proof.* Figure 3.10 shows the only four possible configurations of a Steiner point with two adjacent corners. The cases (a) and (b) cannot exist by Lemma 3.8. A Steiner point has degree at least three, but in cases (c) and (d), the Steiner point cannot have a third edge, since it contradicts Lemma 3.8. Therefore, none of the configurations in Figure 3.10 is possible. □

**Lemma 3.10.** *Let  $u$  and  $v$  be adjacent Steiner points in  $\mathcal{F}$ . Suppose that there exist segments  $l_1$  and  $l_2$  incident to  $u$  and  $v$ , respectively, and on the same side of  $uv$ . Then the shorter one of  $l_1$  and  $l_2$  is a leg of a corner which turns away from the other segment (see Figure 3.11).*

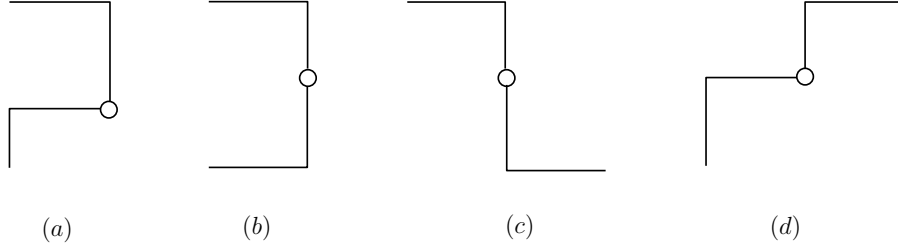

Figure 3.10: Lemma 3.9

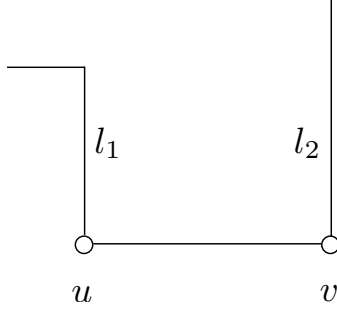

Figure 3.11: Lemma 3.10

*Proof.* Suppose that  $uv$  is horizontal and  $l_1$  and  $l_2$  are above  $uv$ . Without loss of generality, assume  $|l_1| \leq |l_2|$ . The upper endpoint of  $l_1$  cannot be a terminal, for otherwise we can shift  $uv$  to that terminal to change  $\mathcal{F}$  to a non-full RSMT, a contradiction to the assumption that every RSMT for the terminal set of  $\mathcal{F}$  is full. The segment  $l_1$  cannot be incident to any segment extending to the right. For otherwise shifting  $uv$  upwards to overlap with this segment will reduce the length of  $\mathcal{F}$ , a contradiction to optimality of  $\mathcal{F}$ . The upper endpoint of  $l_1$  cannot be a Steiner point, since it has no incident segments in right or upwards directions. Therefore,  $l_1$  ends in a corner which turns away from  $l_2$ .

□

**Corollary 3.2.** *If  $u$  and  $v$  are adjacent Steiner points as in Figure 3.11 and  $l_2$  contains a terminal or a Steiner point, then  $l_1$  is the leg of a corner turning away from  $l_2$  and  $|l_1| \leq |l_2|$ .*

**Lemma 3.11.** *The induced subgraph of the Steiner points in  $\mathcal{F}$  is a chain.*

*Proof.* The induced subgraph of the Steiner points in  $\mathcal{F}$  is connected, for otherwise some Steiner points have to be connected by terminals of degree two or more, and this is not possible since  $\mathcal{F}$  is full. It remains to prove that no Steiner point in  $\mathcal{F}$  is adjacent to more than two other Steiner points. Suppose to the contrary that  $s$  is a Steiner point adjacent to three or four other Steiner points. By lemma 3.8 and 3.9, the connections between  $s$  and its neighbors have one of the forms shown in Figure 3.12.

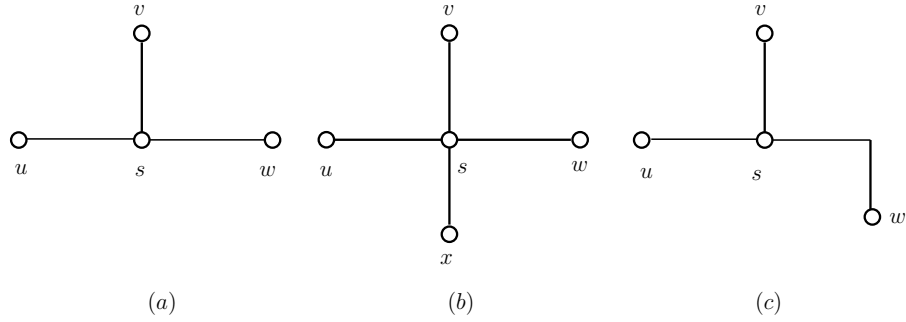

Figure 3.12: A Steiner point adjacent to more than two other Steiner points (Lemma 3.11).

Consider Figure 3.12 (a) and (b). The Steiner point  $v$  needs to have degree three or four, so it has either at least two horizontal edges, or at least one horizontal edge and one vertical edge extending upwards. By Corollary 3.2, a horizontal edge of  $v$  must be shorter than  $sw$  and must be a leg of a corner turning upwards. Therefore, the former case is not possible by Lemma 3.9, and the latter case is not possible by Lemma 3.8. The subgraph in Figure 3.12 (c) cannot exist by a similar argument.

□

We call the chain of Steiner points the *Steiner chain*.

**Lemma 3.12.** *Let  $u$  and  $v$  be two Steiner points in  $\mathcal{F}$  connected by a horizontal segment. Then,  $u$  cannot be connected to a third Steiner point by a vertical segment.*

The proof of this lemma involves similar arguments about impossible configurations. We omit the details.

Define a *staircase* to be a path of xy-monotone vertical and horizontal segments.

**Lemma 3.13.** *The Steiner chain of  $\mathcal{F}$  is a staircase.*

*Proof.* Suppose the Steiner chain bends back as in Figure 3.13, where  $u$  and  $v$  are Steiner points on upper and lower horizontal lines closest to turning points  $\alpha$  and  $\beta$ . From Lemma 3.8, there must be at least two Steiner points on  $\alpha\beta$ . From Lemma 3.12, neither  $\alpha$  nor  $\beta$  can be a Steiner point. From Lemmas 3.8 and 3.11, horizontal edges of Steiner points on  $\alpha\beta$  cannot end in corners or Steiner points, thus they end in a terminal. From Lemma 3.10, the horizontal edges must therefore alternate to right and left. Now  $\alpha\beta$  has more incident edges extending right than left. We can move  $\alpha\beta$  to the right by a series of shifts and flips and save in the length of  $\mathcal{F}$ , a contradiction to optimality of  $\mathcal{F}$ . □

We state the remaining lemmas without proof.

**Lemma 3.14.** *The Steiner chain cannot contain a corner with more than two Steiner points on each surrounding line (see Figure 3.14).*



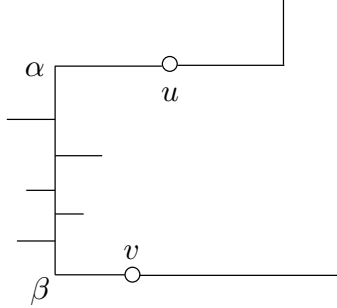

Figure 3.13: Lemma 3.13

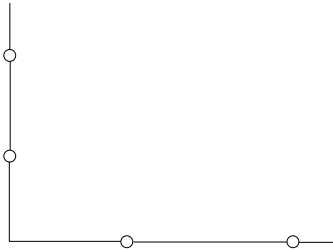

Figure 3.14: Lemma 3.14

**Lemma 3.15.** *The edges in the Steiner chain of  $\mathcal{F}$  that are not corner legs are either all horizontal or all vertical.*

Without loss of generality, we now assume that the Steiner chain of  $\mathcal{F}$  consists of corner legs and horizontal edges.

**Lemma 3.16.** *Each Steiner point in  $\mathcal{F}$  is adjacent to exactly one vertical edge ending in a terminal.*

Starting from the left of the chain, we label the  $i$ th Steiner point by  $s_i$ .

**Lemma 3.17.** *If  $s_i$  and  $s_{i+1}$  are connected through the corner  $\alpha$ ,  $\alpha$  can be transferred to either a corner connecting  $s_{i+1}$  and  $s_{i+2}$  or one connecting  $s_{i-2}$  and  $s_{i-1}$ , by applying a series of shifts and flips, regardless of whether the place where it transfers has a corner or not.*

By pushing all the corners to the right, there will be either no corners in the Steiner chain or at most one corner connecting the two rightmost Steiner points. Therefore, all Steiner points, except possibly the rightmost one, lie on a horizontal line. This, along with Lemma 3.16 completes the proof of Theorem 3.4.

□

### 3.2.2 Rectilinear Steiner Ratio Proof by Salowe [42]

**Theorem 3.5** (Hwang [24]). *Let  $\mathcal{T}$  and  $\mathcal{M}$  be a rectilinear minimum Steiner tree and a rectilinear minimum spanning tree for the terminal set  $P$ , respectively. Then*

$$\rho(P) = \frac{|\mathcal{T}|}{|\mathcal{M}|} \geq \frac{2}{3}.$$

*Proof.* The proof is by induction on the number of terminals ( $|P| = n$ ). The base case of the induction follows from Moore's theorem [20]: For any set of terminals  $P$  in a metric space,

$$|\mathcal{M}(P)| \leq (2 - \frac{2}{|P|})|\mathcal{T}(P)|$$

where  $\mathcal{T}(P)$  and  $\mathcal{M}(P)$  are an SMT and an MST for  $P$ , respectively. For  $1 \leq |P| \leq 4$ , it follows that  $|\mathcal{M}(P)| \leq \frac{3}{2}|\mathcal{T}(P)|$ .

Now suppose that  $P$  is a set of five or more terminals, and for every set of less than  $|P|$  terminals, the minimum spanning tree is at most  $3/2$  times longer than the minimum Steiner tree.

As discussed in the beginning of Section 3.2.1, it suffices to prove the theorem for canonical trees. We assume that  $\mathcal{T}$  is a canonical tree of type (i) (see page 20 for the definition). The proof is similar for canonical trees of type (ii). Starting from the left, label the  $i$ th terminal by  $p_i$ . Label the vertical segment incident to  $p_i$  by  $v_i$ . Note that  $p_0$  is located on the spine and  $|v_0| = 0$ . Label the horizontal segment incident to both  $v_i$  and  $v_{i+1}$  by  $h_i$ . The length of  $\mathcal{T}$  is given by

$$|\mathcal{T}| = \sum_{i=0}^n |v_i| + \sum_{i=0}^{n-1} |h_i|$$

First, we assume that  $|v_n| = 0$ . We discuss the case of  $|v_n| > 0$  at the end of the proof. Find the largest  $k$  such that  $|v_k| \leq |v_{k+2}|$ . Such a  $k$  always exist because  $v_0 = 0 < v_2$ . Furthermore,  $k \leq n - 3$  since  $v_{n-2} > |v_n| = 0$ . Note that  $|v_{k+1}| > |v_{k+3}|$ . We partition  $P$  into three sets:

$$\begin{aligned} P_1 &= \{p_0, \dots, p_k\} \\ P_2 &= \{p_k, p_{k+1}, p_{k+2}, p_{k+3}\} \\ P_3 &= \{p_{k+3}, \dots, p_n\} \end{aligned}$$

Consider the smallest rectangle enclosing all four terminals in  $P_2$  (see Figure 3.15), which we denote by  $R$ . Note that all four terminals lie on the boundary of  $R$ . The perimeter of  $R$  is  $2(|v_{k+1}| + |v_{k+2}| + |h_k| + |h_{k+1}| + |h_{k+2}|)$ . Let  $\pi$  be the path obtained from deleting the longest link between adjacent terminals on the boundary of  $R$ . Then, the length of  $\pi$  is at most  $3/4$  times the perimeter of  $R$ :

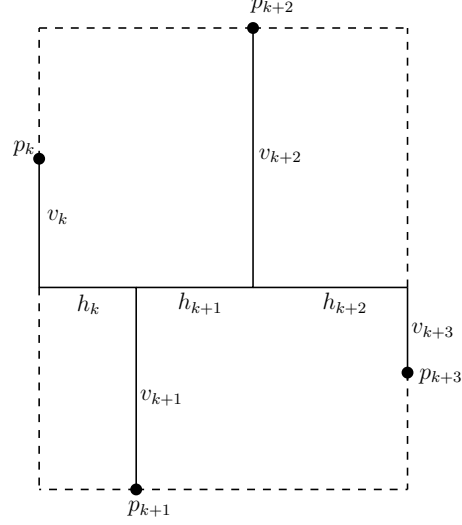

Figure 3.15: The subtree spanning  $p_k, p_{k+1}, p_{k+2}, p_{k+3}$  and its bounding box

$$|\pi| \leq \frac{3}{2}(|v_{k+1}| + |v_{k+2}| + |h_k| + |h_{k+1}| + |h_{k+2}|). \quad (3.4)$$

We build a spanning tree for  $P$ , denote it by  $\mathcal{M}$ , by combining  $\pi$  and minimum spanning trees for  $P_1$  and  $P_3$ . Let  $\mathcal{M}_1$  and  $\mathcal{S}_1$  [ $\mathcal{M}_3$  and  $\mathcal{S}_3$ ] be a minimum spanning tree and a minimum Steiner tree for  $P_1$  [ $P_3$ ], respectively. Then, by induction hypothesis,

$$\begin{aligned} |\mathcal{M}_1| &\leq \frac{3}{2}|\mathcal{S}_1| \\ &\leq \frac{3}{2}\left(\sum_{i=0}^k |v_i| + \sum_{i=0}^{k-1} |h_i|\right). \end{aligned}$$

and also,

$$\begin{aligned} |\mathcal{M}_3| &\leq \frac{3}{2}|\mathcal{S}_3| \\ &\leq \frac{3}{2}\left(\sum_{i=k+3}^n |v_i| + \sum_{i=k+3}^{n-1} |h_i|\right). \end{aligned}$$

The length of  $\mathcal{M}$  is given by

$$\begin{aligned}
|\mathcal{M}| &= |\mathcal{M}_1| + |\mathcal{M}_3| + |\pi| \\
&\leq \frac{3}{2} \left( \sum_{i=0}^n |v_i| + \sum_{i=0}^{n-1} |h_i| \right) \\
&= \frac{3}{2} |\mathcal{T}|
\end{aligned}$$

Theorem 3.5 is proved for the case with  $|v_n| = 0$ . For a minimum Steiner tree  $\mathcal{T}$  with  $|v_n| > 0$ , move  $p_n$  to its incident corner on the Spine to get a Steiner tree of the former type. Now, a minimum spanning tree is no longer than  $3/2$  times a minimum Steiner tree (of length  $|\mathcal{T}| - |v_n|$ ). If we add  $v_n$  to both trees to go back to the original terminal set, it is easy to see that the upper bound of  $3/2$  still holds.  $\square$

### 3.2.3 Rectilinear Steiner Ratio Proof by Berman et al. [4]

An alternative proof to the rectilinear Steiner ratio theorem is given by Berman et al. [4]. In this approach, a pair of sufficiently short spanning trees is built on the terminal set of a canonical RSMT, such that the lengths of the two spanning trees add up to at most three times that of the RSMT. Thus, the shorter of the two spanning trees has length at most  $3/2$  times the length of the RSMT, as required.

To build the two spanning tree, the canonical RSMT is first partitioned into components at the local minima ribs. Recall that ribs are the vertical segments which connect the terminals to the Steiner points. For each component, the so-called *bottom tree* is built by connecting the terminals below the spine in the  $x$ -ordering and connecting each terminal above the spine to the adjacent terminal below the spine and to the right. The so-called *top tree* is built in a similar way, with the role of the terminals above and below the spine reversed and with some exceptions for the terminals around the local maxima rib.

Figure 3.16 shows the two spanning trees. Note that, for ease of understanding, the rectilinear paths are shown by dotted lines connecting the two ends of the path. The thick segments of the RSMT represent the parts of the tree that appear twice in the length of the spanning tree, and the thin segments are the parts that appear at most once. As can be seen in the picture, no segment appears more than three times in total, which gives the required bound on the length of the trees. We omit the details of the proof.

### 3.2.4 An Alternative Proof

In this section, we give a new proof for the rectilinear Steiner ratio theorem, which we extend to the case of obstacles in the next chapter. The proof is inspired by

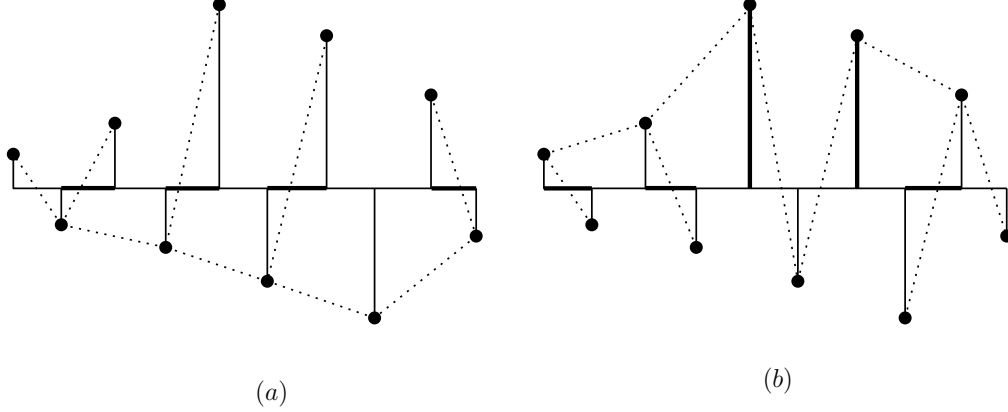

Figure 3.16: The spanning trees of Berman et al. [4] (a) The bottom tree. (b) The top tree.

the proof of Berman et al. [4]. We build a pair of sufficiently short spanning trees, whose lengths sum up to at most three times the length of the Steiner minimal tree. Thus, the shorter of the two spanning trees has length at most  $3/2$  times the length of the RSMT, as required. The difference between this proof and the proof Berman et al. is in the way the two spanning trees are defined.

**Theorem 3.6.** *Let  $\mathcal{T}^*$  be a canonical minimum Steiner tree for an instance of the rectilinear Steiner problem. There are two spanning trees  $T_{green}$  and  $T_{red}$  such that*

$$|T_{green}| + |T_{red}| \leq 3|\mathcal{T}^*|$$

### Notation for Canonical Trees

We denote the spine of a Steiner tree by  $E$ . For convenience of notation, we regard a terminal that lies on the spine (such as the leftmost end of the spine) to be connected to the spine by a rib of length 0. Let  $n_u$  and  $n_l$  be the number of ribs above and below the spine, respectively ( $n_l = n_u$  or  $n_l = n_u \pm 1$ ). We denote by  $R_1, \dots, R_{n_u}$  and  $r_1, \dots, r_{n_l}$  the ribs above and below the spine, in the order of  $x$  coordinate, respectively. Let  $V_i$  and  $v_i$  denote the terminals located on  $R_i$  and  $r_i$ , respectively. Denote by  $S_i$  and  $s_i$  the points at which  $R_i$  and  $r_i$  meet the spine, respectively. These are all Steiner points except the leftmost one which is a terminal and the rightmost one which is either a terminal or a corner. We define a *pocket* as a subtree connecting three terminals consecutive in the  $x$ -ordering. Without loss of generality, we assume that the second leftmost rib is an upper rib. Then the  $i$ th upper pocket, denoted by  $K_i$ , interconnects  $V_{i-1}$ ,  $v_i$  and  $V_i$  via  $s_i$  and the  $i$ th lower pocket, denoted by  $k_i$ , interconnects  $v_i$ ,  $V_i$  and  $v_{i+1}$  via  $S_i$ . This notation is illustrated in Figure 3.17.

We assume that  $\mathcal{T}^*$  is a canonical tree of type (i). The proof is similar for type (ii) canonical trees.

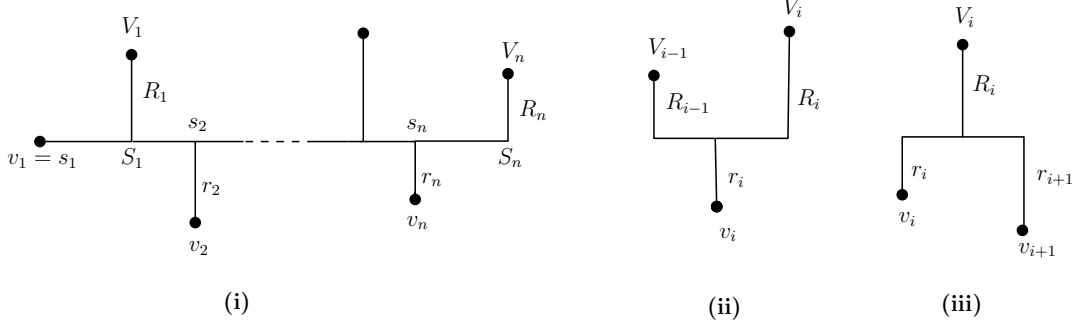

Figure 3.17: (i) Canonical Steiner tree (ii) Upper pocket  $K_i$  (iii) Lower pocket  $k_i$

### The *green* tree

The green tree is built by connecting the points above the spine by a path and connecting each point below the spine to the point on the shorter neighboring upper rib, breaking ties arbitrarily (See Figure 3.18). Consider an upper pocket  $K_i$ . Let  $\Pi_i$  and  $\pi_i$  be the indices of the longer and the shorter upper rib in  $K_i$ , respectively, i.e., if  $|R_i| \leq |R_{i+1}|$  then  $\Pi_i = i + 1$  and  $\pi_i = i$  and otherwise  $\Pi_i = i$  and  $\pi_i = i + 1$ . The length of the subtree connecting the three terminals in  $K_i$ , denoted by  $\tau(K_i)$ , is:

$$\begin{aligned} |\tau(K_i)| &= |r_i| + |R_{\Pi_i}| + |s_i S_{\pi_i}| \\ &= |r_i| + |R_{\Pi_i}| + |2S_{i-1}S_i| - |s_i S_{\Pi_i}| \end{aligned}$$

Summing up over all pockets, every rib is charged once in the spanning tree, except for the locally maximum upper ribs, which are charged twice. Let  $M \subseteq \{2, \dots, n - 1\}$  be the indices of the locally maximum upper ribs, i.e., for  $i \in M$ ,  $|R_i| > |R_{i-1}|, |R_{i+1}|$ . So the length of the green tree is:

$$|T_{green}| \leq \sum_{i=1}^n |R_i| + \sum_{i=1}^n |r_i| + \sum_{i \in M} |R_i| + 2|E| - \sum_{i=2}^n |s_i S_{\Pi_i}| \quad (3.5)$$

Furthermore, note that the set of segments in the last term includes every spine segment next to a locally maximum upper rib. Formally, for  $i \in M$ ,  $\Pi_i = \Pi_{i+1} = i$ . So we can lower bound the last term as follows:

$$\sum_{i=2}^n |s_i S_{\Pi_i}| \geq \sum_{i \in M} |s_i S_i| + |s_{i+1} S_i| = \sum_{i \in M} |s_i S_{i+1}|$$

Now equation (3.5) can be rewritten as:

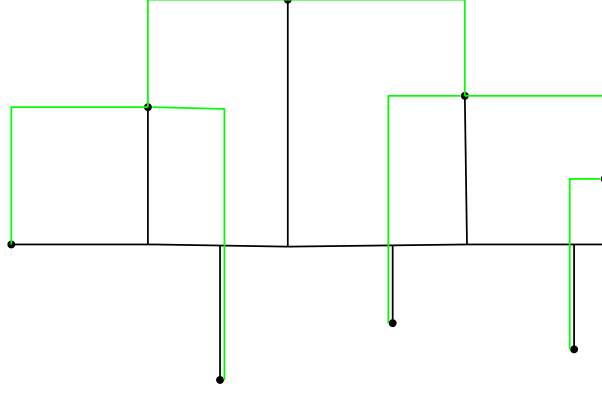

Figure 3.18: The green tree

$$|T_{green}| \leq \sum_{i=1}^n |R_i| + \sum_{i=1}^n |r_i| + \sum_{i \in M} |R_i| + 2|E| - \sum_{i \in M} |s_i s_{i+1}|$$

### The *red* tree

The red tree is built by connecting each point above the spine to the two neighboring points below the spine, with an exception for the points on locally maximum upper ribs (see Figure 3.19). For a lower pocket  $k_i$  with  $i \notin M$ , the length of the subtree connecting terminals in  $k_i$ , denoted by  $\tau(k_i)$ , is

$$|\tau(k_i)| = 2|R_i| + |r_i| + |r_{i+1}| + |s_i s_{i+1}|.$$

For a lower pocket  $k_i$  with  $i \in M$ , we have

$$|\tau(k_i)| \leq |R_i| + |r_i| + |r_{i+1}| + 2|s_i s_{i+1}|$$

Summing up over all pockets, every rib is charged twice, except for the locally maximum ribs, which are charged once. Also, every spine segment is charged once, except for the segments next to a locally maximum rib, which are charged twice. The length of the red tree is:

$$|T_{red}| \leq 2 \sum_{i=1}^n |R_i| - \sum_{i \in M} |R_i| + 2 \sum_{i=1}^n |r_i| + |E| + \sum_{i \in M} |s_i s_{i+1}|$$

Adding up the lengths of two trees together:

$$|T_{green}| + |T_{red}| \leq 3 \sum_{i=1}^n R_i + 3 \sum_{i=1}^n r_i + 3|E| = 3|T^*|$$

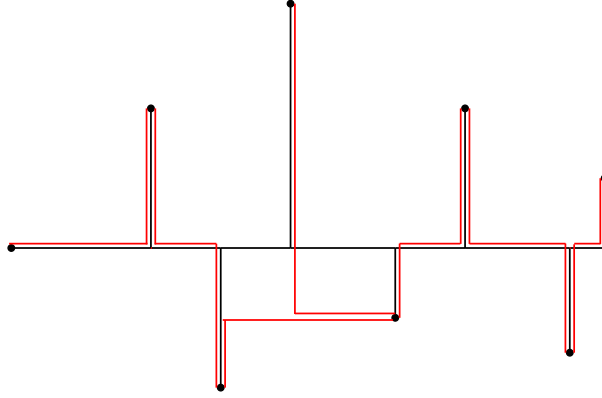

Figure 3.19: The red tree

**Corollary 3.3.** *For any terminal set  $P$ , let  $\mathcal{T}^*$  and  $M^*$  be a rectilinear minimum Steiner tree and a rectilinear minimum spanning tree for  $P$ . Then,*

$$\rho(P) = \frac{|\mathcal{T}^*|}{|M^*|} \geq \frac{2}{3}.$$



# Chapter 4

## Obstacle-Avoiding Steiner Ratio

In this chapter, we study the generalization of the Steiner ratio to the obstacle-avoiding Steiner tree problem.

In the presence of obstacles, an edge of a spanning tree must walk around the obstacles and the length of a minimum spanning tree can be as large as twice the length of a minimum Steiner tree. A natural way to get a better approximation is to allow Steiner points at the obstacle corners. We call a Steiner point *anchored* if it is at the corner of an obstacle and *free* otherwise. We then define an *anchored Steiner tree* as a Steiner tree in which all Steiner points are anchored. Note that if there are no obstacles, then an anchored Steiner tree is a spanning tree.

We define the *obstacle-avoiding Steiner ratio* (denoted by  $\rho$ ) to be the largest lower bound, over all possible sets of terminals and obstacles, of the ratio between the length of an obstacle-avoiding minimum Steiner tree (OASMT) and the length of an anchored OASMT. That is, if for a given set of terminals  $P$  and obstacles  $O$ ,  $T^*(P, O)$  is an OASMT and  $A^*(P, O)$  is an anchored OASMT for  $P$  and  $O$ , then

$$\rho = \inf_{(P,O)} \frac{|T^*(P, O)|}{|A^*(P, O)|}$$

The *visibility graph* of a set of terminals and obstacles is defined as follows: The vertices of the graph are the terminals and the corners of the obstacles. There exists an edge between vertices  $u$  and  $v$  if these vertices are visible, i.e., the segment joining  $u$  and  $v$  does not intersect the interior of any obstacle. An anchored Steiner tree is a minimum Steiner tree in the visibility graph of the set of terminals and obstacles. . The graph Steiner tree problem is NP-complete [28]. Therefore, finding an anchored OASMT is hard as well, But, as we show below, our definition of the Steiner ratio leads to interesting results. In Section 4.2, we show that for the rectilinear metric, the obstacle-avoiding Steiner ratio is equal to the traditional Steiner ratio in the obstacle-free setting. We conjecture that this is the case for the Euclidean metric as well. In Section 4.1, we verify this conjecture for three terminals and any number of obstacles, and prove the lower bound of  $1/\sqrt{3}$ .

## 4.1 Euclidean Obstacle-Avoiding Steiner Ratio

We prove that in Euclidean space and for three terminals and any number of obstacles, the obstacle-avoiding Steiner ratio is  $\sqrt{3}/2$ .

**Theorem 4.1.** *For any terminal set  $P$  of three terminals and obstacle set  $O$ , let  $\mathcal{T}^*$  and  $\mathcal{A}^*$  be an obstacle-avoiding Steiner minimum tree and an anchored obstacle-avoiding Steiner minimum tree for  $(P, O)$ , respectively. Then,*

$$\rho(P, O) = \frac{|\mathcal{T}^*|}{|\mathcal{A}^*|} \geq \frac{\sqrt{3}}{2}.$$

*Proof.*  $\mathcal{T}^*$  has either no free Steiner points or one. In the former case  $\mathcal{T}^* = \mathcal{A}^*$  and the inequality holds trivially. In the latter case, suppose that  $s$  is the free Steiner point and that it is immediately connected to the vertices  $a$ ,  $b$  and  $c$ , which are either terminals or obstacle corners (see Figure 4.1(a)). Recall that the edges at a free Steiner point make  $120^\circ$  angles. Consider a small equilateral triangle with the center  $s$  whose vertices lie on  $sa$ ,  $sb$  and  $sc$ . Expand this triangle until it hits either an obstacle corner or a terminal. Let  $\triangle a'b'c'$  be the resulting triangle. More formally, let  $a'$ ,  $b'$  and  $c'$  be points on  $sa$ ,  $sb$  and  $sc$  such that  $|sa'| = |sb'| = |sc'|$  and the triangle  $\triangle a'b'c'$  contains no obstacle corners or terminals in its interior, and at least one obstacle corner or terminal, which we denote by  $q$ , on its boundary. Without loss of generality, assume that  $q$  lies on  $a'b'$ . Denote by  $\pi[u, v]$  a shortest obstacle-avoiding path from point  $u$  to point  $v$ . Note that such a path is not unique in general, because there may be multiple routes around obstacles. We use  $q$  as an anchored Steiner point to connect  $a$ ,  $b$  and  $c$ . That is, we replace the edges  $sa$ ,  $sb$  and  $sc$  in  $\mathcal{T}^*$  with  $\pi[q, a]$ ,  $\pi[q, b]$  and  $\pi[q, c]$  to get an anchored Steiner tree  $\mathcal{A}$  (see Figure 4.1(b) and (c)). Note that  $|\pi[q, a]|$  is bounded above by  $|aa'| + |a'q|$ , since the path  $aa'q$  avoids obstacles. Let  $\mathcal{F} = \mathcal{T}^* \setminus \{sa, sb, sc\}$ . Then,

$$\begin{aligned} |\mathcal{A}| &= |\mathcal{F}| + |\pi[q, a]| + |\pi[q, b]| + |\pi[q, c]| \\ &\leq |\mathcal{F}| + |aa'| + |a'q| + |bb'| + |b'q| + |cc'| + |c'q| \\ &\leq |\mathcal{F}| + |aa'| + |bb'| + |cc'| + 2|a'b'| \end{aligned}$$

Furthermore,

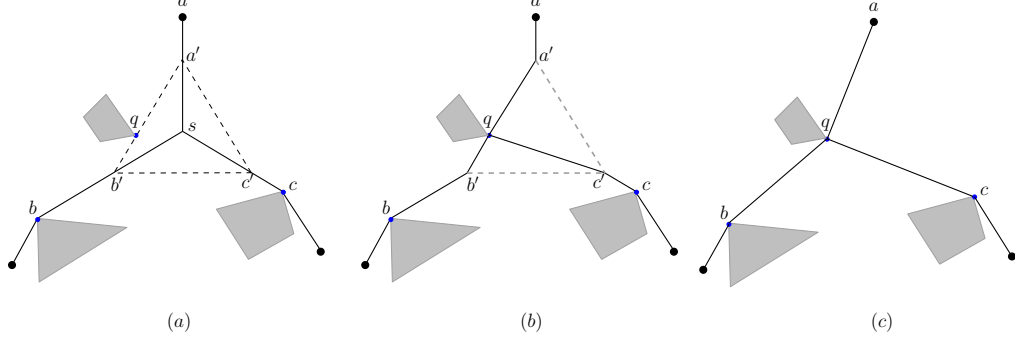

Figure 4.1: Euclidean obstacle-avoiding Steiner ratio for three terminals (a) An OASMT (c) An anchored OASMT.

$$\begin{aligned}
\rho(P, O) &= \frac{|\mathcal{T}^*|}{|\mathcal{A}^*|} \\
&\geq \frac{|\mathcal{F}| + |sa| + |sb| + |sc|}{|\mathcal{F}| + |aa'| + |bb'| + |cc'| + 2|a'b'|} \\
&\geq \frac{|sa| + |sb| + |sc|}{|aa'| + |bb'| + |cc'| + 2|a'b'|} \\
&= \frac{|aa'| + |bb'| + |cc'| + |sa'| + |sb'| + |sc'|}{|aa'| + |bb'| + |cc'| + 2|a'b'|} \\
&\geq \frac{|sa'| + |sb'| + |sc'|}{2|a'b'|}
\end{aligned}$$

where we twice use the fact that  $\frac{A+B}{A+C} \geq \frac{B}{C}$  if  $B \leq C$  and  $A \geq 0$ .

It can be easily seen that  $|sa'| + |sb'| + |sc'| = \sqrt{3}|a'b'|$ . Therefore,  $\rho(P, O) \geq \sqrt{3}/2$ , as required. □

We conjecture that the bound of  $\sqrt{3}/2$  holds for any number of terminals.

**Conjecture 4.1.** *The Euclidean obstacle-avoiding Steiner ratio is  $\sqrt{3}/2$ .*

However, the best bound we are able to prove is  $1/\sqrt{3}$ .

**Theorem 4.2.** *For any terminal set  $P$  and obstacle set  $O$ , let  $\mathcal{T}^*$  and  $\mathcal{A}^*$  be an OASMT and an anchored OASMT for  $(P, O)$ , respectively. Then,*

$$\rho(P, O) = \frac{|\mathcal{T}^*|}{|\mathcal{A}^*|} \geq \frac{1}{\sqrt{3}}.$$

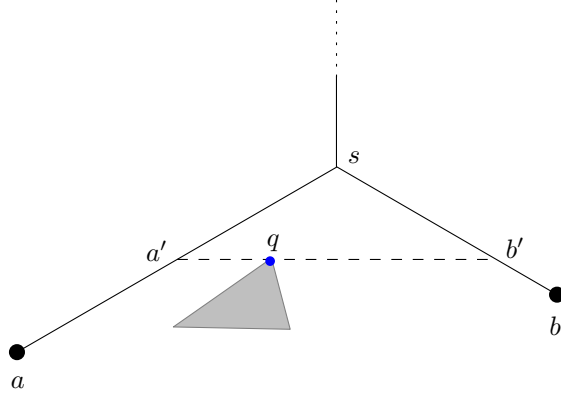

Figure 4.2: Theorem 4.2, a local structure of an OASMT.

*Proof.* By Lemma 3.1, it suffices to prove the theorem for full Steiner trees. We prove the theorem by induction on the number of terminals. The base case  $|P| = 3$  is immediate from Theorem 4.1. Suppose that  $|P| > 3$ , and for every set of less than  $|P|$  terminals, the anchored OARSMT is at most  $\sqrt{3}$  times longer than the OARSMT. Let  $a$  and  $b$  be two terminals adjacent to the same Steiner point  $s$ . The Steiner point  $s$  is not located at an obstacle corner, since by definition a full obstacle-avoiding Steiner tree has no anchored Steiner points. Let  $a'$  and  $b'$  be points on  $sa$  and  $sb$ , respectively, such that  $|sa'| = |sb'|$  and there are no obstacles or terminals in the triangle  $\Delta sa'b'$ . We slide the segment  $a'b'$  away from  $s$  until it hits an obstacle corner or a terminal  $q$  (see Figure 4.2). Now consider the point set  $P' = (P \setminus \{a, b\}) \cup \{q\}$ . Let  $\mathcal{T}'$  and  $\mathcal{A}'$  be an OASMT and an anchored OASMT for  $P'$ , respectively. By the induction hypothesis, we have

$$|\mathcal{A}'| \leq \sqrt{3}|\mathcal{T}'|. \quad (4.1)$$

Furthermore, we get an OAST for  $P'$  by deleting  $sa$  and  $sb$  and adding  $sq$  to  $\mathcal{T}^*$ . Therefore,

$$|\mathcal{T}'| \leq |\mathcal{T}^*| - |sa| - |sb| + |sq|. \quad (4.2)$$

From (4.1) and (4.2), we have

$$\begin{aligned} |\mathcal{A}'| &\leq \sqrt{3}(|\mathcal{T}^*| - |sa| - |sb| + |sq|) \\ &\leq \sqrt{3}(|\mathcal{T}^*| - |sb| - |aa'|). \end{aligned} \quad (4.3)$$

Also, we get an anchored OAST for  $P$  by adding  $\pi[a, q]$  and  $\pi[b, q]$  to  $\mathcal{A}'$ . Therefore,

$$\begin{aligned}
|\mathcal{A}^*| &\leq |\mathcal{A}'| + |\pi[a, q]| + |\pi[b, q]| \\
&\leq |\mathcal{A}'| + |a'b'| + |aa'| + |bb'| \\
&= |\mathcal{A}'| + \sqrt{3}|sb'| + |aa'| + |bb'|.
\end{aligned} \tag{4.4}$$

From (4.3) and (4.4), we have

$$\begin{aligned}
|\mathcal{A}^*| &\leq \sqrt{3}\left(|\mathcal{T}^*| - |sb| - |aa'|\right) + \sqrt{3}|sb'| + |aa'| + |bb'| \\
&\leq \sqrt{3}\left(|\mathcal{T}^*| - |sb| - |aa'|\right) + \sqrt{3}|sb'| + \sqrt{3}|aa'| + \sqrt{3}|bb'| \\
&= \sqrt{3}|\mathcal{T}^*|.
\end{aligned}$$

□

## 4.2 Obstacle Avoiding Rectilinear Steiner Ratio

In this section, we prove that the obstacle-avoiding rectilinear Steiner ratio is  $2/3$ .

**Theorem 4.3.** *For any terminal set  $P$  and obstacle set  $O$ , let  $\mathcal{T}^*$  and  $\mathcal{A}^*$  denote an OARSMT and an anchored OARSMT for  $(P, O)$ , respectively. Then,*

$$\rho(P, O) = \frac{|\mathcal{T}^*|}{|\mathcal{A}^*|} \geq \frac{2}{3}$$

Figure 3.5 on page 19 shows an example of a terminal set  $P$  and an (empty) obstacle set  $O$  such that  $\rho(P, O) = 2/3$ . Therefore, the obstacle-avoiding rectilinear Steiner ratio, defined as

$$\rho = \inf_P \frac{|\mathcal{T}^*|}{|\mathcal{A}^*|}$$

is equal to  $2/3$ .

We give a characterization of obstacle-avoiding rectilinear minimum Steiner trees in Section 4.2.1, and we obtain the Steiner ratio in Section 4.2.2 using the result in Section 4.2.1.

### 4.2.1 Canonical Obstacle-Avoiding Steiner Trees

As in the obstacle-free case (see Lemma 3.1), if a terminal set has an obstacle-avoiding minimum Steiner tree that is not full, then we can decompose it into full components. Thus it suffices to consider terminal sets for which every minimum

Steiner tree is full. We prove such a terminal set has a canonical OARSMT. This was proved for the obstacle-free case by Hwang [24] (Corollary 3.1) and we follow his approach.

Recall the notion of shift and flips from Section 3.2.1. Hwang, in his proof of Theorem 3.4, considers a terminal set  $P$  such that every RSMT for  $P$  is full. He proves various properties of an RSMT  $\mathcal{F}$  for  $P$ , mostly by contradiction, relying on the fact that no shift or flip can decrease the length of  $\mathcal{F}$  or transform it into a non-full tree. In the last step of his proof, he applies a series of shifts and flips to  $\mathcal{F}$  to transform it into canonical form. In order to apply Hwang's proof to the obstacle-avoiding case, it is sufficient to show that the shifts and flips used in his proof do not violate the obstacle-avoiding property:

**Lemma 4.1.** *Let  $P$  and  $O$  be a set of terminals and obstacles, respectively, such that every OARSMT for  $(P, O)$  is full, and let  $\mathcal{T}$  be an OARSMT for  $(P, O)$ . Then, shift and flip transformations can be done on  $\mathcal{T}$  as if there were no obstacles, without violating the obstacle-avoiding property.*

*Proof.* Assume by contradiction that there exists a transformation  $H$  mapping  $\mathcal{T}$  to  $\mathcal{T}'$  such that  $\mathcal{T}'$  violates the obstacle-avoiding property. First consider the case where  $H$  is a shift from the segment  $xy$  to  $x'y'$  such that  $x'y'$  intersects an obstacle (Figure 4.3). Since the obstacles are rectilinear, there exists at least one obstacle corner inside the rectangle  $xyy'x'$ . Let  $c$  be the closest such obstacle corner to  $xy$ , breaking ties arbitrarily. Then, we can shift  $xy$  to  $c$  to get an OARSMT for  $(P, O)$  which is not full, a contradiction. Next, consider the case where  $H$  is a flip from the corner  $\alpha$ , between the points  $x$  and  $y$ , to the corner  $\alpha'$  such that at least one of the legs of  $\alpha'$  intersects with an obstacle. Then, there exists at least one obstacle corner inside the rectangle  $x\alpha y\alpha'$ . Let  $c$  be the closest such obstacle corner to  $\alpha$ , breaking ties arbitrarily. We can flip  $\alpha$  to  $c$  to get an OARSMT for  $(P, O)$  which is not full, a contradiction. □

Hwang's proof can therefore be applied unchanged to prove the following theorem:

**Theorem 4.4.** *For any terminal set  $P$  and obstacle set  $O$ , there is an OARSMT whose full components are in canonical form.*

## 4.2.2 Proof of the Steiner Ratio Theorem (Theorem 4.3)

*Proof.* By Lemma 3.1 and Theorem 4.4, it suffices to prove the theorem for canonical Steiner trees. We build a pair of sufficiently short anchored Steiner trees on  $P$ , the *green tree* and the *red tree*, such that their lengths add up to at most  $3|\mathcal{T}^*|$  (see Figure 4.4). The smaller of the two trees is thus of length at most  $\frac{3}{2}|\mathcal{T}^*|$ .

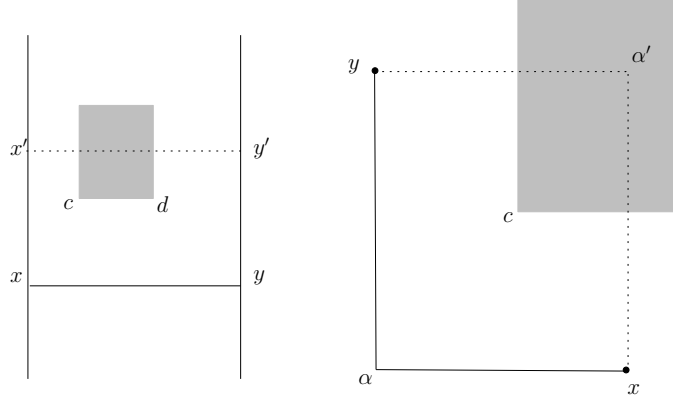

Figure 4.3: Shifting and flipping in the presence of obstacles

We use the notation given in Section 3.2.4, for the terminals, Steiner points, spine, ribs and pockets of a canonical Steiner tree. Define the *height* of a point  $q$  as its distance from the spine and denote it by  $\mathcal{H}(q)$ . Denote by  $\mathcal{I}(q)$  the image of  $q$  projected on the spine.

We first assume that  $\mathcal{T}^*$  is a canonical tree of type (i) (see Figure 3.6). Type (ii) trees are discussed at the end of the proof. We identify a subset of obstacle corners, called the *critical corners*, and use them to replace the free Steiner points of  $\mathcal{T}^*$  in the green and red trees. For each upper pocket, consider the set of all obstacle corners located above the spine and between the two upper ribs, such that their heights are less than the length of the shorter upper rib. We define a *critical corner* as the corner with the minimum height in this set, breaking ties arbitrarily. If there is no such obstacle corner, the critical corner is the terminal located on the shorter upper rib and is called a *virtual critical corner*. A critical corner in a lower pocket is defined analogously. Denote by  $C_i$  and  $c_i$  the critical corner in the upper pocket  $K_i$  and lower pocket  $k_i$ , respectively. Note that a critical corner can be connected to a terminal in its pocket by an obstacle-avoiding path, consisting of two straight lines, of length equal to the rectilinear distance between them. This enables us to ignore all other obstacles in the construction of the anchored Steiner trees.

### The Green Tree

For each upper pocket  $K_i$ , we connect the three terminals in the pocket,  $v_i$ ,  $V_{i-1}$ , and  $V_i$ , through the critical corner  $C_i$  (see Figure 4.5). The length of the resulting subtree, which we denote by  $\tau(K_i)$ , is

$$|\tau(K_i)| = |R_{i-1}| + |R_i| - \mathcal{H}(C_i) + |r_i| + |S_{i-1}S_i| + |s_i\mathcal{I}(C_i)|.$$

If the leftmost or the rightmost terminal is not included in any upper pocket, we connect it to the next terminal in the  $x$ -ordering. Summing over all upper pockets,

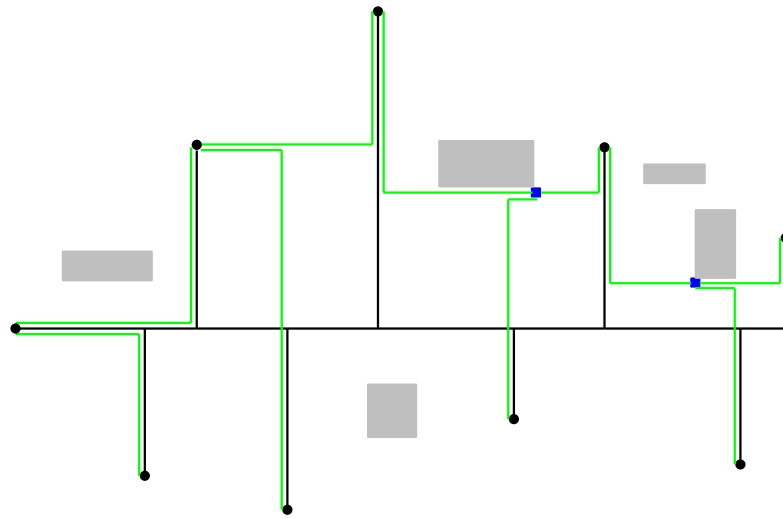

(a)

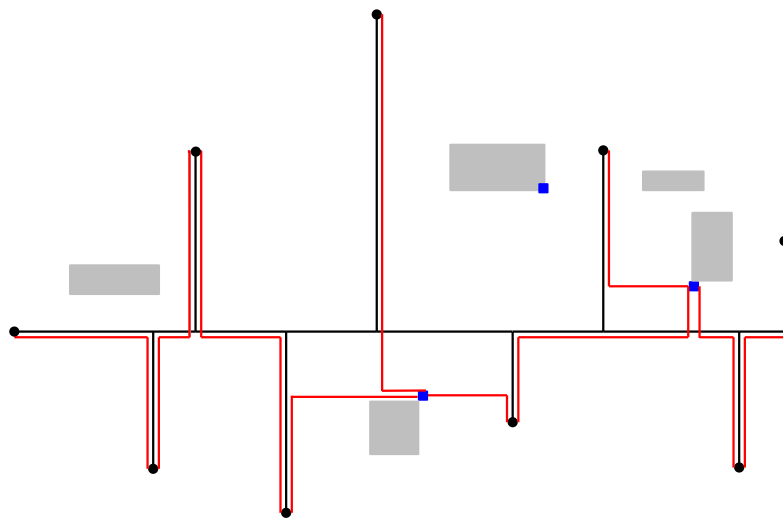

(b)

Figure 4.4: The pair of anchored Steiner trees. (a) The green tree. (b) The red tree. The square-shaped dots are the critical corners.



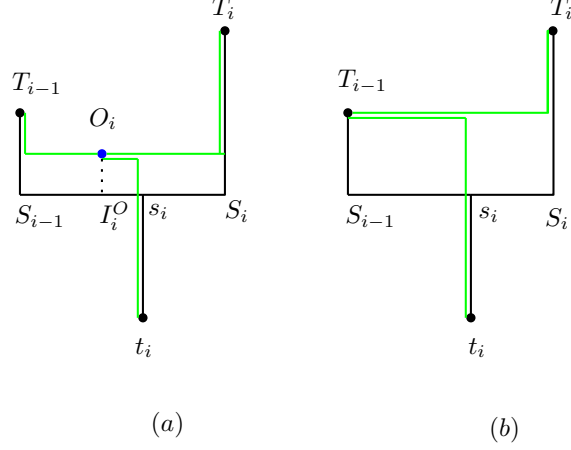

Figure 4.5: The green tree

the length of the green tree is

$$|\mathcal{T}_{green}| = 2 \sum_{i=1}^{n_u} |R_i| + \sum_{i=1}^{n_l} |r_i| - \sum_{i=1}^{n_u} \mathcal{H}(C_i) + |E| + \sum_{i=1}^{n_u} |s_i \mathcal{I}(C_i)|.$$

## The Red Tree

An upper critical corner  $C_i$  is *involved* in a lower pocket  $k_i$  if it is located between the extensions of  $r_i$  and  $r_{i-1}$ , i.e., if  $x_{v_{i-1}} \leq x_{C_i} \leq x_{v_i}$ .

For each lower pocket  $k_i$ , we connect the three terminals in the pocket through an upper critical corner involved in the pocket. There can be 0, 1 or 2 critical corners involved in the pocket. We consider each case separately.

Case 1: There is one upper critical corner,  $C_j$  ( $j = i$  or  $i + 1$ ), involved in  $k_i$ . We connect  $v_i$ ,  $V_{i-1}$  and  $V_i$  to  $C_j$  (see Figure 4.6 (a) and (b)). In this case, the length of the resulting subtree, which we denote by  $\tau(k_i)$ , is:

$$\begin{aligned} |\tau(k_i)| &= |R_i| + |r_i| + |r_{i+1}| + \mathcal{H}(C_j) + |s_i s_{i+1}| + |S_i \mathcal{I}(C_j)| \\ &\leq |R_i| + |r_i| + |r_{i+1}| + \mathcal{H}(C_j) + 2|s_i s_{i+1}| - |s_j \mathcal{I}(C_j)| \end{aligned}$$

Case 2: There are two upper critical corners,  $C_i$  and  $C_{i+1}$ , involved in  $k_i$ . We connect  $v_i$ ,  $V_{i-1}$ , and  $V_i$  to  $C_{i+1}$  (see Figure 4.6(c)). Then,

$$|\tau(k_i)| = |R_i| + |r_i| + |r_{i+1}| + \mathcal{H}(C_{i+1}) + |s_i s_{i+1}| + |S_i \mathcal{I}(C_{i+1})|. \quad (4.5)$$

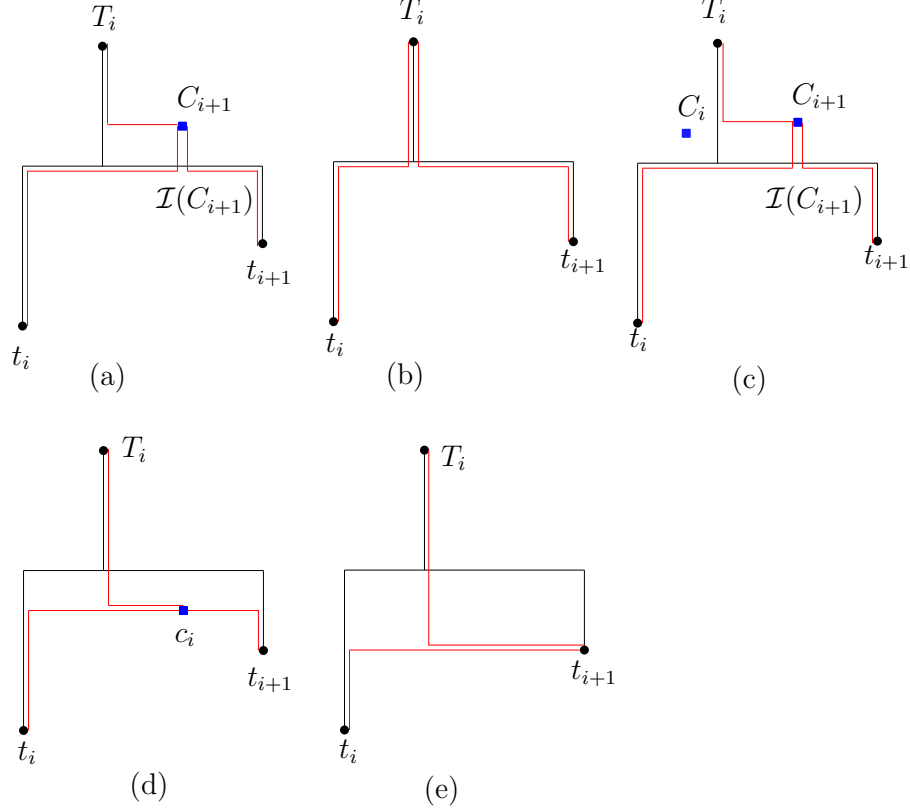

Figure 4.6: The red tree: a) One non-virtual upper critical corner. b) Virtual upper critical corner. c) Two upper critical corners. d) No upper critical corner, non-virtual lower critical corner. e) No upper critical corner, virtual lower critical corner

We want the term  $\mathcal{H}(C_i) - |s_i \mathcal{I}(C_i)|$  to appear exactly once for each critical corner  $C_i$ , so that it is canceled by the term  $|s_i \mathcal{I}(C_i)| - \mathcal{H}(C_i)$  in the green tree's length. Therefore, we re-write (4.5) as

$$\begin{aligned}
 |\tau(k_i)| \leq & |R_i| + |r_i| + |r_{i+1}| + \mathcal{H}(C_i) + \mathcal{H}(C_{i+1}) \\
 & + 2|s_i s_{i+1}| - |s_i \mathcal{I}(C_i)| - |s_{i+1} \mathcal{I}(C_{i+1})|
 \end{aligned}$$

Case 3: There are no upper critical corners involved in  $k_i$ . In this case, we use the lower critical corner in  $k_i$ , i.e.  $c_i$ , and connect it to  $v_i$ ,  $V_{i-1}$ , and  $V_i$  (see Figure 4.6(d) and (e)). Then,

$$|\tau(k_i)| \leq |R_i| + |r_i| + |r_{i+1}| + 2|s_i s_{i+1}|.$$

If the leftmost or the rightmost terminal is not included in any lower pocket, we connect it to the next terminal in the  $x$ -ordering. Summing over all lower pockets, the length of the red tree is :

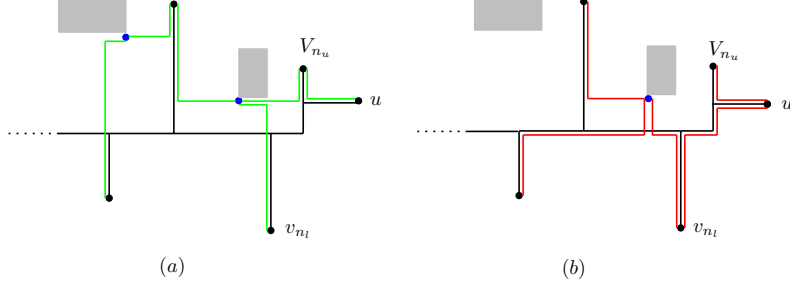

Figure 4.7: The green and red trees for type  $(ii)$  canonical trees.

$$|\mathcal{T}_{red}| \leq \sum_{i=1}^{n_u} |R_i| + 2 \sum_{i=1}^{n_l} |r_i| + \sum_{i=1}^{n_u} \mathcal{H}(C_i) + 2|E| - \sum_{i=1}^{n_u} |s_i \mathcal{I}(C_i)|$$

Now we add up the lengths of the two trees together:

$$|\mathcal{T}_{green}| + |\mathcal{T}_{red}| \leq 3 \sum_{i=1}^{n_u} |R_i| + 3 \sum_{i=1}^{n_l} |r_i| + 3|E| = 3|\mathcal{T}^*|$$

This completes the proof for canonical trees of type  $(i)$ . Now assume that  $\mathcal{T}^*$  is a canonical tree of type  $(ii)$ . First, we ignore the rightmost terminal, which we denote by  $u$ , and its edge to get a type  $(i)$  tree and we build the green and red trees as above. Then, we add to the green tree a path from  $V_{n_u}$  to  $u$  (see Figure 4.7(a)) and modify the path between  $v_{n_l}$  and  $V_{n_u}$  in the red tree to pass through  $u$  (see Figure 4.7 (b)). It is easy to see that the lengths of the two trees still add up to less than 3 times the length of  $\mathcal{T}^*$ . This completes the proof of Theorem 4.3.

□

# Chapter 5

## Approximation Algorithms

We survey the background literature on polynomial-approximation schemes for different versions of the Steiner tree problem: the Euclidean and rectilinear Steiner tree problems in Section 5.1.1, the graph Steiner tree problem in Section 5.1.2, and the Euclidean and rectilinear obstacle-avoiding Steiner tree problems in Section 5.1.3. In Section 5.2, we give a new constant-factor approximation algorithm for the Euclidean obstacle-avoiding Steiner problem, based on the obstacle-avoiding Steiner ratio idea.

### 5.1 Background on PTASs for the Steiner Tree Problem

A *polynomial-time approximation scheme* or PTAS is a family of algorithms such that for any given  $\epsilon > 0$ , the corresponding algorithm runs in polynomial time and, for every input, returns a solution whose value is within a  $1 + \epsilon$  factor of the optimal solution.

#### 5.1.1 The Euclidean and Rectilinear Steiner Tree Problems

Arora [3] and Mitchell [31] independently obtained a PTAS for the Euclidean and rectilinear Steiner problems in 1996. The running time of Arora's algorithm is  $O(n(\frac{1}{\epsilon} \log n)^{O(\log n)})$  (later improved to  $O(n \log n)$  by Rao and Smith [38]), while Mitchell's algorithm runs in time  $O(n^{O(1/\epsilon)})$ .

#### 5.1.2 The Graph Steiner Tree Problem

The current best approximation algorithm for the graph Steiner tree problem is due to Robins and Zelikovsky [39] and has a performance ratio of 1.55. The problem

does not admit a PTAS unless  $P = NP$ . This follows from the fact that the problem is APX-complete [5]. Moreover, it is NP-hard to approximate the graph Steiner tree problem within ratio  $96/95$  [8]. However, the problem admits a PTAS if the input is restricted to planar graphs. A PTAS for the planar graph Steiner problem was recently proposed by Borradaile, Klein and Mathieu [6, 7]. The running time of the algorithm in [7] is  $O(n \log n)$  and is exponential in  $\text{poly}(1/\epsilon)$ . This algorithm is used in approximation schemes for the geometric versions of the Steiner tree problem, which we will discuss in the next section.

### 5.1.3 The Euclidean and Rectilinear Obstacle-Avoiding Steiner Tree Problems

The rectilinear obstacle-avoiding Steiner tree problem can be reduced to the graph Steiner problem: The escape graph of Ganley and Cohoon [17] (see page 10 for the definition) contains an OARSMT. The escape graph is planar, so one can apply the algorithm of Borradaile et. al [6] for planar graphs to the escape graph to find a  $(1 + \epsilon)$ -approximate OARSMT.

For the Euclidean metric, Provan [37] has shown how to approximate an OASMT by a graph Steiner tree problem within a ratio of  $1 + \epsilon$ . The approximation is achieved by placing a grid of  $O(n^2/\epsilon^2)$  points on the plane, which serve as candidate Steiner points. The visibility graph of the terminals, obstacles and the grid points contains an SMT which is a  $(1 + \epsilon)$ -approximate solution to the obstacle-avoiding Steiner tree problem. An alternative construction is given by Müller-Hannemann and Tazari [33] in which a grid of  $O(\frac{1}{\epsilon} n \log n)$  candidate Steiner points is used.

A PTAS for the Euclidean obstacle-avoiding Steiner tree problem (discussed in [33]) can be obtained using either of the above constructions, as follows.

A  $t$ -spanner of a graph  $G = (V, E)$  is a subgraph of  $G$  that contains a path between any two vertices  $u, v \in V$  that is at most  $t$  times longer than the shortest path between  $u$  and  $v$  in  $G$ . Let  $G_v$  be the visibility graph of the terminals, grid points and obstacles. A planar  $(1 + \epsilon)$ -spanner of  $G_v$  is found using Arikati et al.'s algorithm [2]. This spanner contains a  $(1 + \epsilon)$ -approximate OASMT. One can find this approximate OASMT using the algorithm of Borradaile et. al [7] for planar graphs. The running time of the algorithm is  $O(n^2 \log n)$  when using Provan's grid [37] and is  $O(n \log^2 n)$  when using the grid of Müller-Hannemann and Tazari [33]. Both running times are exponential in  $\text{poly}(1/\epsilon)$ . If the grid of Müller-Hannemann and Tazari is used, the algorithm also works for the rectilinear metric.

## 5.2 Constant Factor Approximation Algorithm for the Obstacle-Avoiding Rectilinear Steiner Tree Problem

We give an approximation algorithm for the obstacle-avoiding Euclidean Steiner tree problem, using similar techniques as in the PTAS discussed in section 5.1.3. The performance ratio of this algorithm is arbitrary close to the inverse of the Euclidean obstacle-avoiding Steiner ratio (denoted by  $\rho$ ). We conjecture that  $\rho = \sqrt{3}/2$ , and that the performance ratio of the following algorithm is  $\frac{2}{\sqrt{3}}(1 + \epsilon)$ .

Let  $P$  and  $O$  be a set of terminals and obstacles, respectively, and let  $n$  be the total number of terminals and obstacle corners. Every edge of an anchored OASMT is a visibility segment and thus an anchored OASMT is a minimum Steiner tree in the visibility graph of  $P \cup O$ . We first build a planar spanner of the visibility graph and then apply the PTAS for the Steiner tree problem in planar graphs. To elaborate, first find a planar  $(1 + \epsilon/2)$ -spanner  $G$  of the visibility graph of  $P \cup O$ , using the algorithm of Arikati et al. [2]. This algorithm introduces  $O(n)$  Steiner points in order to achieve planarity. Note that it is not needed to explicitly construct a full visibility graph. The spanner  $G$  has  $n$  vertices and  $O(n)$  edges and can be found in  $O(n \log n)$  time. Next, we find a  $(1 + \epsilon/2)$ -approximate minimum Steiner tree  $\mathcal{T}$  in the graph  $G$  using the planar graph PTAS of Borradaile et al. [7]. This step runs in  $O(2^{poly(1/\epsilon)}n + n \log n)$  time. The Steiner tree  $\mathcal{T}$  may have free Steiner points (the points introduced to achieve planarity), so it is not an anchored Steiner tree. However,  $G$  contains a  $(1 + \epsilon)$ -approximate anchored OASMT, which is no shorter than  $\mathcal{T}$ . Thus,  $\mathcal{T}$  is a  $\frac{1}{\rho}(1 + \epsilon)$ -approximate OASMT. The total running time of the algorithm is  $O(n \log n)$  and it is exponential in  $poly(1/\epsilon)$ .

The main difference between this algorithm and the PTASs of Provan [37] and Müller-Hannemann and Tazari [33] is in the additional points introduced in the construction of the planar graph. While we introduce only  $O(n)$  additional points in order to achieve planarity, the constructions in [37] and [33] introduce  $O(n^2/\epsilon^2)$  and  $O(\frac{1}{\epsilon^{11}}n \log n)$  additional points, respectively, which serve as candidate Steiner points. As a result of this, our algorithm achieves a constant performance ratio in contrast to the performance ratio of  $(1 + \epsilon)$  in [33] and [37], but with a better running time.

# Chapter 6

## Conclusion

We have introduced the concept of the obstacle-avoiding Steiner ratio, and have shown that, for the rectilinear metric, its value interestingly coincides with the Steiner ratio in the obstacle-free setting. Our work leaves open the value of the obstacle-avoiding Steiner ratio in the Euclidean metric and in other uniform-orientation metrics such as the octilinear metric.

One possible way to attack the Euclidean obstacle-avoiding Steiner ratio is to extend Du and Hwang’s proof [15] for the Euclidean Steiner ratio to the case with obstacles. In particular, Du and Hwang use a minimax theorem to show that the ratio between the lengths of an SMT and an MST is maximized for a set of terminals with the maximum number of minimum spanning trees, namely for terminals on an equilateral triangular lattice. Using a similar approach, one may be able to prove that the ratio between the lengths of an OASMT and an anchored OASMT is maximized for a set of terminals and obstacles with the maximum number of anchored OASMTs, and that this condition implies an equilateral triangular lattice of terminals and a certain “symmetry” in the relative positions of the obstacle corners and terminals. We believe that it is possible to extend our proof for  $n = 3$  in such a setting, i.e., to find an obstacle-corner or terminal for each Steiner point that can approximate it well enough.

# References

- [1] M. Ajtai, V. Chvatal, M. Newborn, and E. Szemerédi. Crossing free subgraphs. *Annals of Discrete Mathematics*, 12:9–12, 1982.
- [2] S. R. Arikati, D. Z. Chen, L. P. Chew, G. Das, M. H. Smid, and C. D. Zaroliagis. Planar spanners and approximate shortest path queries among obstacles in the plane. In *Proceedings of the Fourth Annual European Symposium on Algorithms*, volume 1136 of *Lecture Notes in Computer Science*, pages 514–528. Springer-Verlag, 1996.
- [3] S. Arora. Polynomial time approximation schemes for Euclidean TSP and other geometric problems. In *Journal of the ACM*, pages 2–11, 1996.
- [4] P. Berman, U. Fössmeier, M. Karpinski, M. Kaufmann, and A. Zelikovsky. Approaching the  $5/4$ -approximation for rectilinear Steiner trees. In *Proceedings of the Second Annual European Symposium on Algorithms*, volume 855 of *Lecture Notes in Computer Science*, pages 60–71, 1994.
- [5] M. Bern and P. Plassmann. The Steiner problem with edge lengths 1 and 2. *Information Processing Letters*, 32(2):171–176, 1989.
- [6] G. Borradaile, C. Kenyon-Mathieu, and P. N. Klein. A polynomial-time approximation scheme for Steiner tree in planar graphs. In *Proceedings of the Eighteenth Annual ACM-SIAM Symposium on Discrete Algorithms*, pages 1285–1294, 2007.
- [7] G. Borradaile, C. Kenyon-Mathieu, and P. N. Klein. Steiner tree in planar graphs: an  $O(n \log n)$  approximation scheme with singly exponential dependence on epsilon. In *Proceedings of the 10th Workshop on Algorithms and Data Structures*, volume 4619 of *Lecture Notes in Computer Science*, pages 275–286. Springer-Verlag, 2007.
- [8] M. Chlebík and J. Chlebíková. Approximation hardness of the steiner tree problem on graphs. In *Proceedings of the 8th Scandinavian Workshop on Algorithm Theory*, volume 2368 of *Lecture Notes in Computer Science*, pages 170–179. Springer-Verlag, 2002.
- [9] F. R. K. Chung and R. L. Graham. A new bound for Euclidean Steiner minimal trees. *Annual New York Academy of Sciences*, 440:328–346, 1985.



- [10] F. R. K. Chung and F. K. Hwang. A lower bound for the Steiner tree problem. *SIAM Journal on Applied Mathematics*, 34(1):27–36, 1978.
- [11] K. L. Clarkson. Approximation algorithms for shortest path motion planning. In *Proceedings of the Nineteenth Annual ACM Symposium on Theory of Computing*, pages 56–65, 1987.
- [12] H. Courant and R. Robbins. *What is Mathematics?* Oxford University Press, New York, 1941.
- [13] P. O. De Wet. *Geometric Steiner minimal trees*. PhD thesis, University of South Africa, 2008.
- [14] D. Z. Du and F. K. Hwang. A new bound for the Steiner ratio. *Transactions of the American Mathematical Society*, 278(1):137–148, Jul. 1983.
- [15] D. Z. Du and F. K. Hwang. A Proof of the Gilbert-Pollak conjecture on the Steiner ratio. *Algorithmica*, 7(2&3):121–135, 1992.
- [16] D. Z. Du, F. K. Hwang, and E. Y. Yao. The Steiner ratio conjecture is true for five points. *Journal of Combinatorial Theory*, 38(2):230–240, 1985.
- [17] J. L. Ganley and J. P. Cohoon. Optimal rectilinear Steiner tree routing in the presence of obstacles. In *IEEE International Symposium on Circuits and Systems*, volume 1, pages 113–116, 1994.
- [18] M. R. Garey, R. L. Graham, and D. S. Johnson. The complexity of computing Steiner minimal trees. *SIAM Journal on Applied Mathematics*, 32(4):835–859, 1977.
- [19] M. R. Garey and D. S. Johnson. The rectilinear Steiner tree problem is NP-complete. *SIAM Journal on Applied Mathematics*, 32(4):826–834, 1977.
- [20] E. N. Gilbert and H. O. Pollak. Steiner minimal trees. *SIAM Journal on Applied Mathematics*, 16(1):1–29, 1968.
- [21] R. L. Graham and F. K. Hwang. Remarks on Steiner minimal trees. *Bulletin of Institute of Mathematics, Academia Sinica*, 4:177–182, 1976.
- [22] M. Hanan. On Steiner’s problem with rectilinear distance. *SIAM Journal on Applied Mathematics*, 14(2):255–265, 1966.
- [23] R. B. Hayward. A lower bound for the optimal crossing-free Hamiltonian cycle problem. *Discrete Computational Geometry*, 2(4):327–343, 1987.
- [24] F. K. Hwang. On Steiner minimal trees with rectilinear distance. *SIAM Journal on Applied Mathematics*, 30(1):104–114, 1976.
- [25] F. K. Hwang, D. Richards, and P. Winter. *The Steiner tree problem*. North-Holland, 1992.

- [26] F. K. Hwang and J. F. Weng. The shortest network under a given topology. *Journal of Algorithms*, 13(3):468–488, 1992.
- [27] V. Jarník and O. Kossler. On minimal graphs containing  $n$  given points. *Casopis P esk. Mat. F yr.*, 63:223–235, 1934.
- [28] R. Karp. Reducibility among combinatorial problems. In R. E. Miller and J. W. Thatcher, editors, *Complexity of Computer Computations*, pages 85–103. Plenum Press, New York, 1972.
- [29] J. B. Kruskal. On the shortest spanning subtree of a graph and the traveling salesman problem. *Proceedings of the American Mathematical Society*, 7:48–50, 1956.
- [30] A. Z. Melzak. On the problem of Steiner. *Canadian Mathematical Bulletin.*, 4:143–148, 1961.
- [31] J. S. B. Mitchell. Guillotine subdivisions approximate polygonal subdivisions: a simple polynomial-time approximation scheme for geometric TSP,  $k$ -MST, and related problems. *SIAM Journal on Computing*, 28(4):1298–1309, 1999.
- [32] M. Müller-Hannemann and A. Schulze. Hardness and approximation of octilinear Steiner trees. *International Journal of Computational Geometry and Applications*, 17(3):231–260, 2007.
- [33] M. Müller-Hannemann and S. Tazari. A near linear time approximation scheme for Steiner tree among obstacles in the plane. In *Proceedings of the 10th Workshop on Algorithms and Data Structures*, volume 4619 of *Lecture Notes in Computer Science*, pages 151–162. Springer-Verlag, 2007.
- [34] H. O. Pollak. Some remarks on the Steiner problem. *Journal of Combinatorial Theory*, 24(3):278–295, 05 1978.
- [35] R. C. Prim. Shortest connection networks and some generalizations. *Bell System Technical Journal*, 36:1389–1401, 1957.
- [36] H. J. Promel and A. Steger. *The Steiner tree problem: a tour through graphs, algorithms, and complexity (Vieweg advanced lectures in mathematics)*. Friedrich Vieweg & Son, 2002.
- [37] J. S. Provan. An approximation scheme for finding Steiner trees with obstacles. *SIAM Journal of Computing*, 17(5):920–934, 1988.
- [38] S. B. Rao and W. D. Smith. Approximating geometrical graphs via “spanners” and “banyans”. In *Proceedings of the thirtieth annual ACM symposium on Theory of computing*, pages 540–550, New York, 1998. ACM.
- [39] G. Robins and A. Zelikovsky. Improved Steiner tree approximation in graphs. In *11th Annual ACM-SIAM Symposium on Discrete Algorithms*, pages 770–779, 2000.

- [40] J. H. Rubinstein and D. A. Thomas. The Steiner ratio conjecture for six points. *Journal of Combinatorial Theory*, 58(1):54–77, 1991.
- [41] J. H. Rubinstein and D. A. Thomas. A variational approach to the Steiner network problem. *Annals of Operations Research*, 33(1-4):481–499, 1991.
- [42] J. S. Salowe. A simple proof of the planar rectilinear steiner ratio. *Operations Research Letters*, 12(4):271–274, 1992.
- [43] W. D. Smith. How to find Steiner minimal trees in Euclidean  $d$ -space. *Algorithmica*, 7(2-3):137–177, 1992.
- [44] D. Trietsch and F. K. Hwang. An improved algorithm for Steiner trees. *SIAM Journal on Applied Mathematics*, 50(1):244–263, 1990.
- [45] P. Winter. An algorithm for the Steiner problem in the Euclidean plane. *Networks*, 15(3):323–345, 1985.
- [46] M. Zachariasen and P. Winter. Obstacle-avoiding Euclidean Steiner trees in the plane: an exact algorithm. In *Workshop on Algorithm Engineering and Experimentation*, volume 4619 of *Lecture Notes in Computer Science*, pages 282–295. Springer-Verlag, 1999.