

Oakland Media Library
urban communication space

by

Emily Claire Wessel

A thesis
presented to the University of Waterloo
in fulfillment of the thesis requirement for the degree of
Master of Architecture

Waterloo, Ontario, Canada, 2007
© Emily Wessel 2007

Author's Declaration

I hereby declare that I am the sole author of this thesis. This is a true copy of the thesis, including any required final revisions, as accepted by my examiners.

I understand that my thesis may be made electronically available to the public.

ABSTRACT :

Oakland Media Library : urban communication space

As North American cities experience rapid changes in demographics, communication technology, and economy, how will urban libraries continue to hold meaning and usefulness to their publics? Investigating the position of the municipal public library in the multicultural city, the thesis focuses on how this civic institution can be a social gathering place and a venue that supports multiple forms of communication and cultural contestation. Oakland, California is the site for an exploration of these concepts and their application in a design proposal.

Oakland is a diverse and segregated city which is currently undergoing a new wave of development. The city's history reveals how the formation of urban communities has often been intimately connected with the uses and transformations of public space. The history also illustrates the ways that public life has been performed within and defined by the public spaces of the city. An investigation of the Library's story and myths highlights the gap between the institution's utopian self-conception and its less than egalitarian history. To develop new visions for the municipal library, theories about public space and urban life are considered in light of changing technologies and communication methods currently affecting the public realm. The juxtaposition of these concepts suggests that in order to improve the popularity and relevance of the Library, an expansion and diversification of its urban, social and practical functions is necessary. The design proposal for the Oakland Media Library integrates this broadened idea of the Library into the city fabric, and renews the Library's meaning and usefulness by conceiving it as an urban communication space.

Aknowledgements

I would like to thank my supervisor Marie-Paule Macdonald for her consistent engagement and encouragement. I also am indebted to my committee Lola Sheppard and Bob McNair for their guidance and inspiration, and Andrew Frontini, for his time and interest as external reader. Finally, I would not be here without my parents, Colleen and Gary, or my partner, Mark – thanks so much for your unwavering support, editing, and love.

CONTENTS

Author's Declaration	iii
Abstract	v
Acknowledgements	vi
Contents	vii
List of Illustrations	ix
Introduction	1
1 OAKLAND URBAN HISTORY	3
2 PUBLIC LIBRARY : HISTORIES, ROLES, VISIONS	13
Brief History of the Municipal Public Library	13
Urban Library an a Public Space : public sphere, 'contact', 'lively urban space'	17
Urban Library as a Place for Communication: multiple media, social contexts, communication in physical space	20
Vision of the Public Library : Urban Communication Space	23
3 PROPOSAL : OAKLAND MEDIA LIBRARY	27
Urban Networks: Infrastructures, Open Spaces, Cultural Agencies	27
Design Strategies: Social Places and Architectural Elements	35
Sky Realm	37
Street Realm	39
Media Realm	43
Structure	47
Circulation	51
Skin	55
Patron Sketches	59
Conclusions	61
Design Drawings	63
Appendices	83
IFLA / UNESCO Public Library Manifesto	84
ACSA student design competition entry	86
Site Selection	90
Image Credits	93
Bibliography	97

LIST OF ILLUSTRATIONS

See Image Credits section for source information.

1 OAKLAND URBAN HISTORY

##	Name	page
1.1	San Francisco Bay Area - County and City Populations	2
1.2	Panorama of Oakland (1908)	3
1.3	Original Oakland City Plan (1850)	3
1.4	Pastoral Rendering of Alameda County Landscape (1878)	3
1.5	Southern Pacific Train at Seventh & Broadway (1900s)	4
1.6	Major Construction - Broadway & San Pablo (1906)	4
1.7	Oakland City Hall Construction (1914)	4
1.8	Downtown Oakland Plan (1878)	4
1.9	Second Oakland Main Library (1902)	5
1.10	Key System Electric Passenger Streetcar on Broadway	5
1.11	Klan Initiation Oakland Auditorium (1924)	5
1.12	Bay Bridge Construction (1936)	5
1.13	Liberty Ship Launch at Kaiser Shipyards (1942)	6
1.14	Wartime Wealth (Dorothea Lange)	6
1.15	Downtown Oakland Plan (1950s)	6
1.16	General Strike 1946 - Protesters on Broadway	7
1.17	Business Elite	7
1.18	Main Oakland Public Library (1951)	7
1.19	Freeway Construction (1955)	7
1.20	Black Panther Party 'Free Huey' Protest (1968)	8
1.21	Downtown Oakland Plan (1985)	8
1.22	Renovated Paramount Theatre	9
1.23	Renovated Victorians in Old Oakland	9
1.24	City Center Mall	9
1.25	Oakland Population Growth	10
1.26	Oakland vs. California Populations	10
1.27	Art and Soul Festival – Downtown Oakland (2006)	10

2 PUBLIC LIBRARY

2.1	Library Stacks	13
2.2	Boston Public Library	14
2.3	Woodcut from Jonathan Swift's 'Battle of the Books'	14
2.4	Library photo by Candida Höffer (2002)	15
2.5	London Coffeehouse 1700s	17
2.6	Busy Urban Public Space	19
2.7	"What Makes a Great Place"	19
2.8	Reading	21
2.9	Storytelling	21
2.10	Music / Video performance	21
2.11	Spoken Word performance	21
2.12	Outdoor Seating in Oakland's City Center Mall	22

3 PROPOSAL : OAKLAND MEDIA LIBRARY

##	Name	Page
3.0	Downtown Oakland Aerial Photo	26
3.1	Downtown Oakland Points of Reference and Neighbourhoods	26
3.2	Central Business District - view Southward along Broadway	27
3.3	Downtown Oakland Cultural / Educational / Arts Venues	28
3.4	Bay Area Rapid Transit (BART) System Map	29
3.5	Downtown Oakland Transportation	29
3.6	Downtown Oakland Open Space and Recreation	30
3.7	Lafayette Park - 'Block Park'	31
3.8	Lake Merritt - 'Landscape Park'	31
3.9	Frank Ogawa Plaza - 'Urban Plaza'	31
3.10	Oakland Museum - 'Hybrid'	31
3.11	Site Section across Broadway	32
3.12	Surrounding Urban Context	32
3.13	Site Photo A - From 11th and Broadway	33
3.14	Site Photo B - from 12th and Broadway	33
3.15	Site Elevation (Broadway)	33
3.16	'3 URBAN REALMS'	34
3.17	Early Concept Sketch	35
3.18	Layered Public Spaces	35
3.19	Early Atrium rendering	35
3.20	Roof Garden Detail Sketch	36
3.21	Views from Roof Garden	36
3.22a	Roof Terrace in downtown San Francisco	37
3.22b	Roof Garden View	37
3.23	Street Realm Diagram	38
3.24a	Sidewalk Space	38
3.24b	Vancouver Public Library Entry Mall	39
3.24c	Idea Store, Whitechapel, London	39
3.25	View into Gallery and Art Workshop	40
3.26	Main Entry Lobby	41
3.27	Atrium Entry	42
3.28	Early Atrium Sketch	43
3.29	Second Floor Lounge	43
3.30	Atrium Configuration Options	44
3.31	Main Reading Hall View	45
3.32	Precedents	46
3.33	Main Architectural Elements : Structure, Circulation, Skin	46
3.34	Sketch Models	47
3.35	Atrium Shape Diagram	47
3.36	Structural Diagrams and Details	48
3.37	Circulation Concept Sketches	50
3.38	Circulation Elements	50

LIST OF ILLUSTRATIONS

3.39	Crossing the Atrium - Sketch	51
3.40	Second to Third Level - Sketch	51
3.41	Stair Detail	51
3.42	Reading Bridge	52
3.43	Atrium - view to the North	53
3.44	Facade Sketches	54
3.45	Solar Diagram	54
3.46	Oakland Average Temperatures	54
3.47	Textural Context	55
3.48	Material Palette	55
3.49	Facade Detail	56
3.50	Exterior View	57
3.51	Patron Sketches	59
3.52	Library Program	60

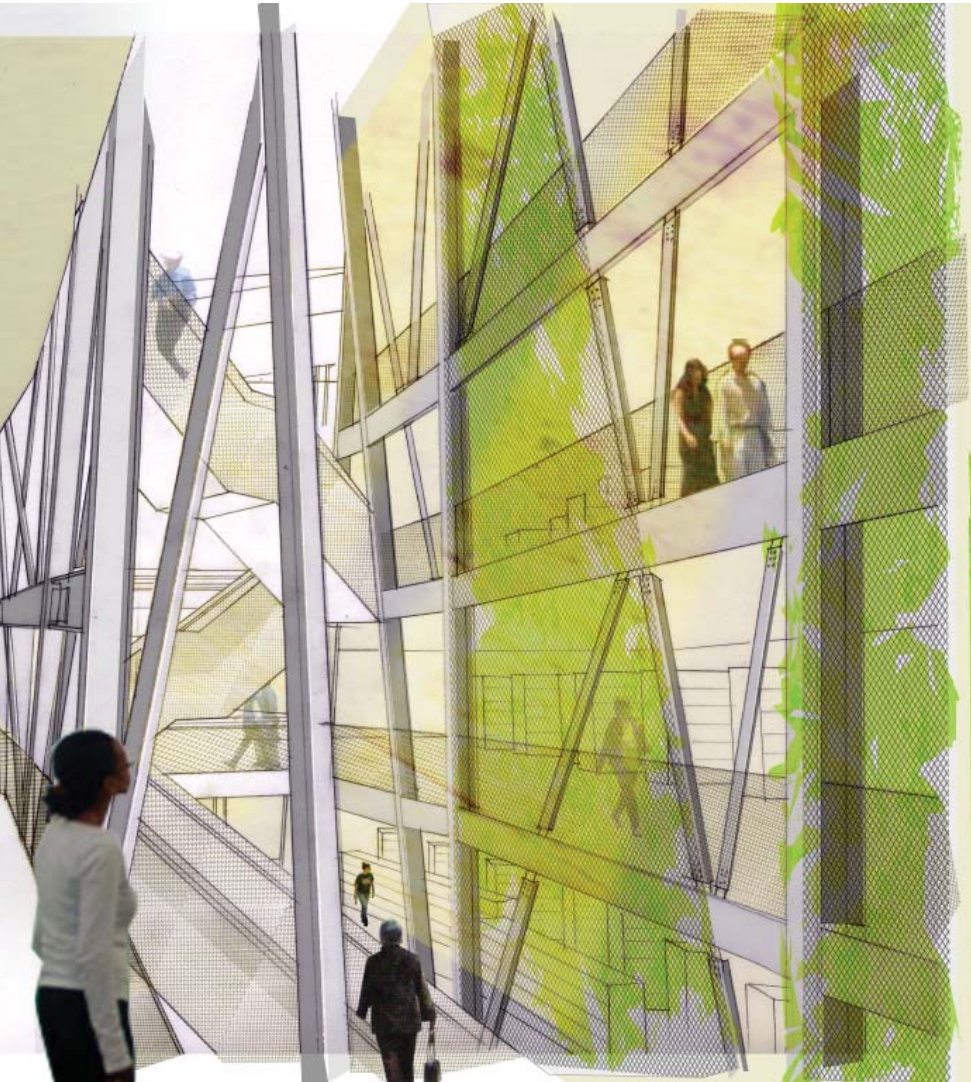

INTRODUCTION :

Urban Development, Cultural Change, and the Public Library

Urban life in North America is undergoing a period of change, affected by shifts in the social and economic composition of cities. During the last century, cheap energy spurred an outward pattern of urban development in North America. The movement of the middle class from urban cores out to streetcar neighbourhoods, and later to suburbs, contributed to radical changes in urban culture, social order, and virtually every facet of life. As energy resources become insufficient to maintain this way of living, new forms of development will occur, and are already occurring. Cities and their economies will be fundamentally affected by this coming transformation.

This thesis considers the position of one public institution – the municipal public library – as this new period of change begins. The city of Oakland, California is chosen as the context for this exploration, at a point in its history when renewed investment is affecting the downtown. Oakland's downtown is marked by changes in development and demographics; it is a revealing case study of the urban effects of "the most extensive internal migrations in American history: the migration of southern African Americans to the cities of the Northeast, Midwest, and West and the mass movement of whites to suburban places."¹ Forty years after this migration, Oakland is even more diverse, yet quite segregated, and home to a 'majority-minority' population – a demographic which will describe the United States as a whole by 2050.²

The position of the Public Library in a multicultural city is explored following two lines of inquiry. First is a set of questions about urban public space: its purposes, functions, and design. Second is a set of ideas about how new communication technologies are affecting our culture and abilities to act and interact in an age some describe as the 'Information Society', or 'Knowledge Economy'. In a multi-cultural and economically unequal city, public space and access to information are important resources, as they hold some potential for advancing a just urban society.

This investigation broadens the discussion of the library's roles, inviting new functions and meanings to infiltrate and invigorate the institution. The design proposal follows this lead to suggest strategies to improve the Library's relevance to a wider range of Oakland's diverse public. As the informational primacy of the Library is challenged by the Internet, the library can renew its meaning and usefulness by redefining itself as a social gathering place - a venue that supports multiple forms of communication and cultural contestation.

1 Robert O Self. *American Babylon : race and the struggle for postwar Oakland*. Princeton, N.J.: Princeton University Press, 2003. 136.

2 Farai Chideya. *The Color of our Future*. New York: William Morrow, 1999. 5.

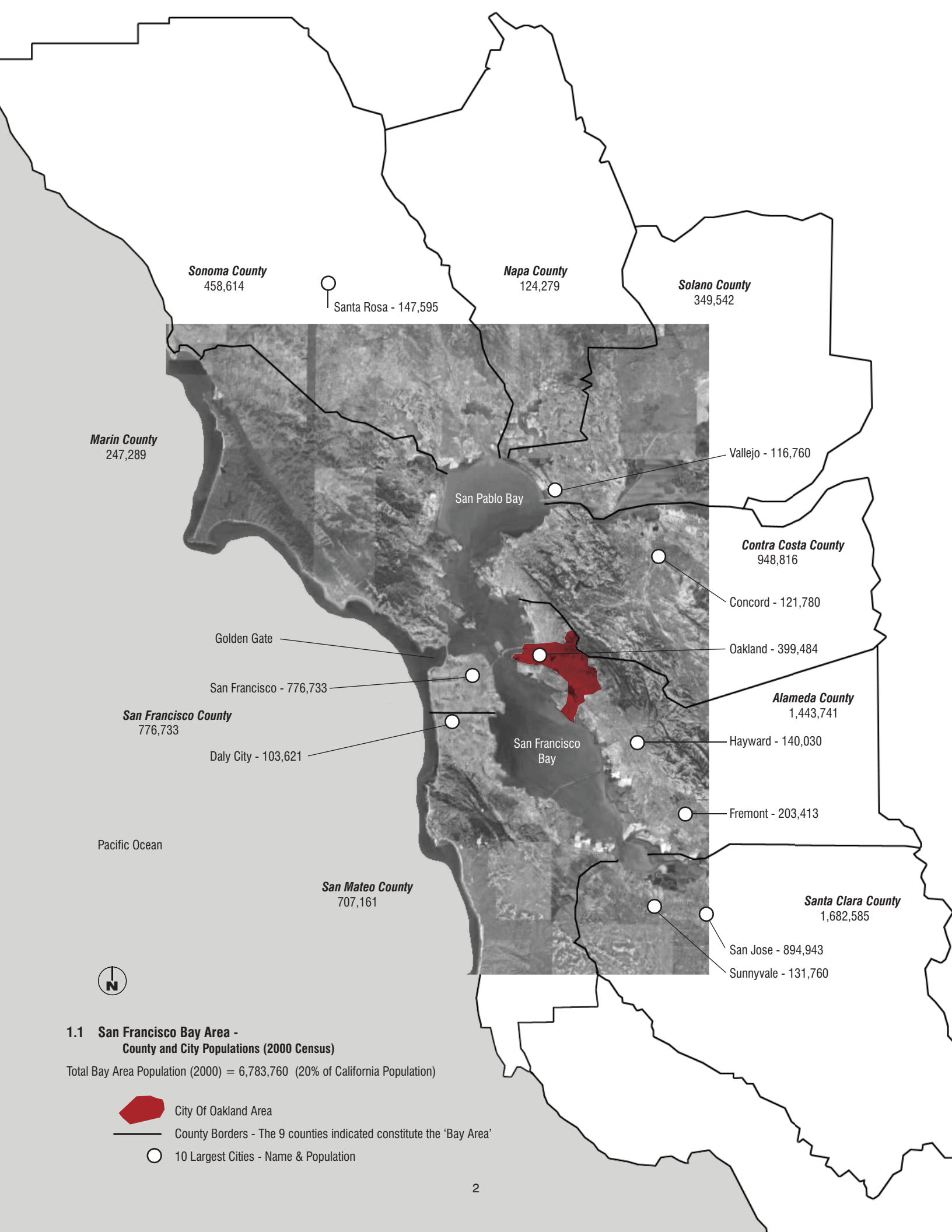

City Of Oakland Area



County Borders - The 9 counties indicated constitute the 'Bay Area'



10 Largest Cities - Name & Population

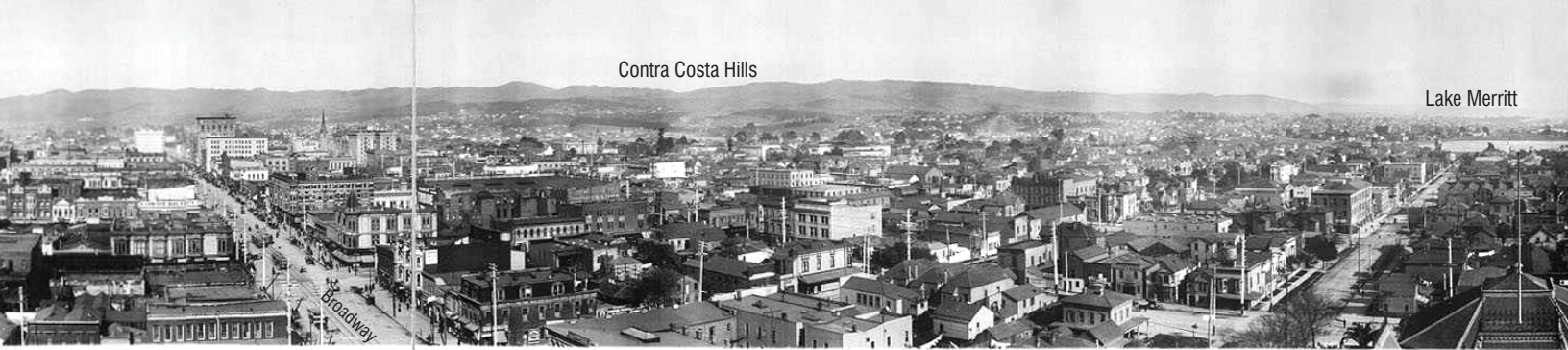

1.2 Panorama of Oakland (1908)
from Old City Hall at 5th Street and Broadway

CHAPTER 1

OAKLAND URBAN HISTORY :

multicultural, contested, segregated, vibrant

Public space in Oakland, California has been the site and subject of cultural conflicts, which in some cases made lasting marks upon the urban landscape. Several periods of intense change have transformed the city's economy, population, and mode of urban development. These transformations have radically affected Oakland's urban culture and social structure. They have also caused the formation of groups or 'counter-publics' which challenged the status-quo, against the 'dominant public' which fought to uphold it. The story of Oakland's public library system is part of this historical account. The development of the Library, a public cultural and educational institution, reflected the changing use of public space in the city.

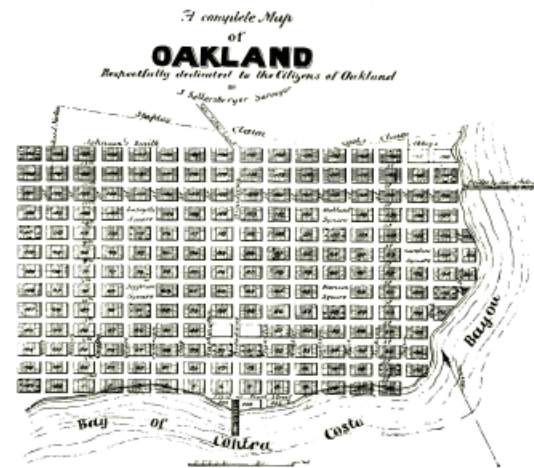

1.3 Original Oakland City Plan (1850)

Oakland is located in northern California, on the eastern shore of San Francisco Bay. It is a city of 400,000 people within a metropolis of six million. Geologically, the San Francisco Bay Area straddles the boundary between the north-westerly moving Pacific plate and the south-easterly moving North American plate. Its faulted terrain hides suppressed forces which periodically cause violent upheavals of the land. The bay creates several distinct microclimates within the region. In summer, hot air rising off the East Bay hills draws cold ocean air across the San Francisco Peninsula. This dynamic causes fog and wind in San Francisco, while Oakland experiences hot, dry summers and moist winters, characterizing its climate as "Mediterranean".¹

Populated since 1200 B.C. by the Ohlone people, the region came under Spanish and later Mexican jurisdiction, before becoming part of the United States in 1850. The California Gold Rush that began in 1848 brought many newcomers to the region, turning San Francisco into a boomtown. In 1850, the 'founding fathers' of Oakland leased the land which is now Oakland from the Mexican Peralta family. After having a city plan drawn, they began to illegally sell properties.² As Oakland writer Ishmael Reed described it, "By the time the courts sided with the Peralta family, the squatters had established a city with the lead swindler electing himself mayor."³



1.4 Pastoral Rendering of Alameda County Landscape (1878)



1.5 Southern Pacific Train at Seventh & Broadway (1900s)



1.6 Major Construction - Broadway & San Pablo (1906)



1.7 Oakland City Hall Construction (1914)





The town's population grew slowly until 1869, when it became the western terminus of the first transcontinental rail line, and new industries and shipping brought prosperity. The city's early population were largely working-class European immigrants who laboured in canneries, small shops, and at the docks. A small number of African American railroad porters settled in West Oakland, and a sizeable Chinatown was formed by immigrants who had worked building the railroad through the Sierra Nevada mountain range.

Public service corporations, run by speculators for profit, provided basic city services such as water, power and transportation, and during the early years urban politics largely revolved around these contracts. In city government, power was held through system of ethnic patronage, by politicians who controlled access to jobs for the ethnically-defined population.⁴ Most developments in public space involved city infrastructure, such as street paving, electrification, and land creation via infill. This era saw the establishment of the first main public library downtown, and a reading room in West Oakland, where the working-class population lived near the docks the rail yards.⁵

After the 1906 earthquake and fire in San Francisco, many people and businesses moved to Oakland, including a number of Chinese and African Americans who were prevented from rebuilding in their original San Francisco neighbourhoods. The city economy grew when the port was dredged, and Oakland prospered through the 1920s. The 'Key System' electric streetcar network connected Oakland to all other East Bay cities, and also made a connection via ferry to San Francisco. This enhanced Oakland's viability as a commuter 'bedroom' to San Francisco. Much of the historic stock of buildings standing today were built between 1900 and 1930.⁶



1.8 Downtown Oakland Plan (1878)

-  Railroads
-  Extents of Original Plan
-  Original Block Parks
-  Inlet + Estuary

During this period of wealth, a civic beautification plan was made, the Oakland Parks commission was created, and Lakeside Park at Lake Merritt was created. The Oakland Public Library also expanded, building two branches in 1899, the second main branch, a Carnegie-endowed building in 1902, and 12 more branches between 1911 and 1932, several funded by Carnegie.⁷ This surge in branch library building responded to a population which was expanding outwards from the downtown core into streetcar suburbs along the Key System's lines. In contrast to downtown neighbourhoods that were somewhat racially and ethnically tolerant, new subdivisions in the East and North of the city had covenants or city ordinances barring access to racially defined minorities ("Africans", "Asiatics", "Orientals").⁸ In these streetcar suburbs, a new counter-public was formed – a group that was primarily Protestant and native-born who became the predecessors of "white middle class."⁹ This group united politically on issues such as street paving, and opposed the dominant municipal politics of ethnic patronage. This led to the rise of a significant Ku Klux Klan movement in Oakland in the mid-1920s – a movement powerful enough to install its members into city government, yet which did not fundamentally change the regime.¹⁰

At the same time, labour unions formed other counter-publics, as they organized at the docks, canneries, and rail yards. Department stores anchored a vibrant downtown shopping culture, restaurants and blues bars lined West Oakland's Seventh Street strip, and movie palaces such as the Fox Theatre and the Paramount Theatre were built to the north of downtown. In the pre-WWII city, a "heterogeneous urban public forged a new kind of culture". This inclusiveness, however, was restricted by an exclusion of racially defined minorities.¹¹

The Great Depression brought an end to the civic expansion campaign; but the federal Public Works Administration funded several projects in the area, including the Bay Bridge, which linked Oakland to San Francisco. Library construction halted, not to be resumed until after WWII.¹²



1.9 Second Oakland Main Library (1902). Now home to African American Museum and Library



1.10 Key System Electric Passenger Streetcar on Broadway

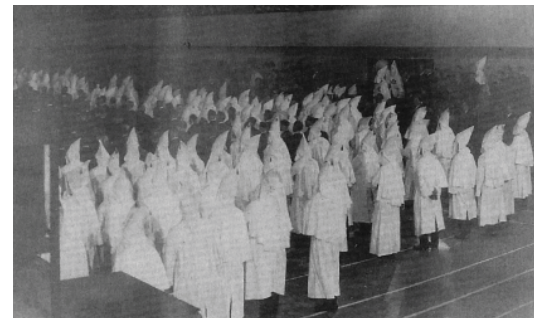

1.11 Klan Initiation Oakland Auditorium (1924)



1.12 Bay Bridge Construction (1936)

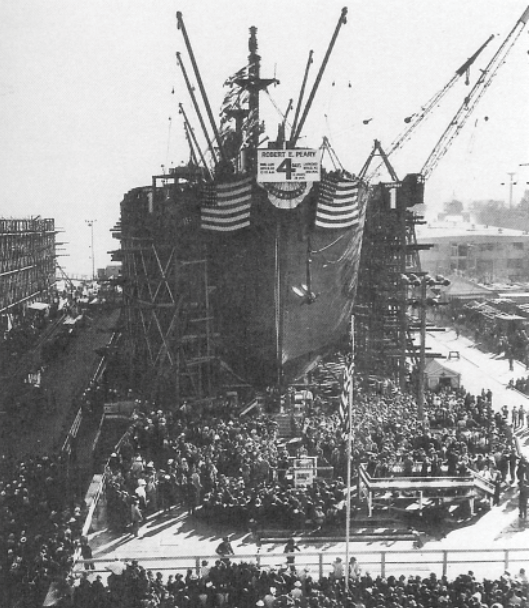

1.13 Liberty Ship Launch at Kaiser Shipyards (1942)

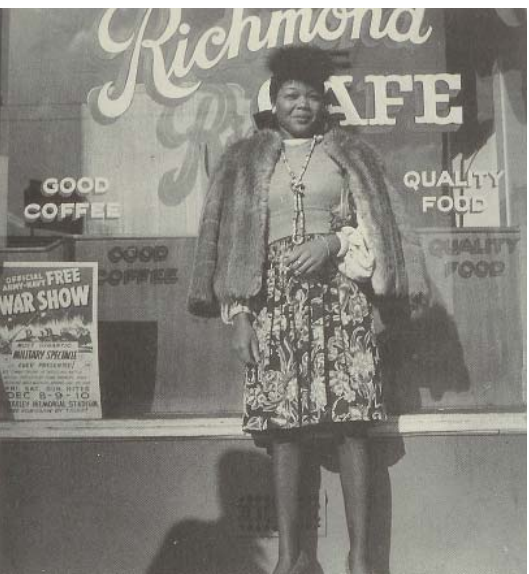

1.14 Wartime Wealth - defence jobs brought wealth to new groups: women, migrants, African Americans, and youth. Photographer Dorothea Lange documented these new social conditions in her portraits of East Bay life during the war.

With the start of war, Oakland boomed, and there was a huge wave of immigration to fill wartime jobs. One particularly visible migrant group were African-Americans from the South, who settled in West Oakland.¹³ Wartime jobs opened new opportunities to women, migrants, Blacks, and youth, creating a new social climate and “challenging the established social customs and boundaries that governed downtown life.”¹⁴ Wartime wealth supported an urban culture of consumption, retail profits quadrupled, and people flocked to movie-palaces and dance halls. Shift-workers with money to spend kept the downtown open for business 24 hours a day. Yet as the previous hierarchy broke down, and formerly suppressed groups “asserted their claims to public space,” the middle class and business elites attempted to “crack down”, blaming these groups for an increase in “immoral public behaviour”, and attempting to curtail their freedoms.¹⁵ Police conducted raids on African American and Hispanic neighbourhoods, jailing those who could not produce a draft card, and selectively enforcing draft law against African American and Hispanic men.¹⁶ While disposable income gave new freedoms to several groups, conflicts over housing, jobs, and social norms increased official segregation within public spaces such as dance halls and bars. Blues musician Ron Stewart, describing the Oakland blues scene of the 1940s, noted the vibrant yet segregated quality of the urban culture of the time: “They had black and white clubs, segregated, but lined up one next to the other.”¹⁷



1.15 Downtown Oakland Plan (1950s)

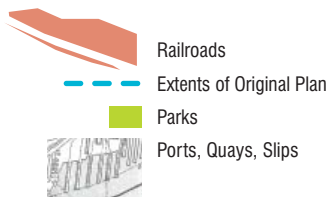

After the war, shipyards closed down and unemployment rose, causing widespread anxiety over job stability, which contributed to a strike of department store workers in 1946. When city police escorted non-union workers past strike lines, it ignited the outrage of local unions and caused a two-day General Strike. The city shut down as more than 100,000 people protested in Frank Ogawa Plaza and along Broadway.¹⁸ This event could be considered a watershed moment in the life of the downtown, a premonition of the departure of post-war plenty from the urban core. That same year, the Key System streetcar company was sold to National City Lines, which dismantled the rails, converted the system to bus lines, and sold the company back to the city in 1960. Despite the turning economy, some civic projects were still happening downtown. In 1947 construction started on a civic centre project at the shore of Lake Merritt.¹⁹ The current Oakland Main Library was built in 1951 as part of this project. Several branch libraries were added in inner and outer suburbs, as the library system responded to the population increase which had occurred over the war years.

Major movements of people and power were underway as highway construction and suburban development caused the mass departure of the middle class from the downtown and inner city neighbourhoods. Between 1955 and 1960, property values in the central business district dropped by half.²⁰ Department stores moved out, taking with them the vitality invested by the middle class consumer culture, which had been a crucial component of Oakland's urban public life since the turn of the century. While job opportunities for many groups had expanded, African Americans did not share in these new opportunities due to discriminatory hiring practices. As both small businesses and major employers such as General Motors left downtown for the suburbs, unemployment and poverty in minority neighbourhoods rose. As the inner city became increasingly impoverished and jobless, federal urban renewal projects were proposed for the city, specifically for West Oakland, which was home to a large percentage of the African-American population. While 'renewal' programs closed down many public housing projects and seized property, powerful groups against public housing prevented many projects from being rebuilt. The results were stark: after many thousands were displaced, "between 1945 and 1965, the city constructed a total of only five hundred public housing units."²¹ And at the same time, the private market for homes was also bleak. For example, from "1949 to 1951 ... Bay Area cities issued more than 75,000 building permits for private dwellings of which only 600 [0.8%] were open to black buyers."²² Construction of freeways and the Bay Area Rapid Transit system (BART) also impacted West Oakland. The Interstate 980 Freeway was carved through the city, forming an imposing moat between West Oakland and the central business district. And the BART line, located underground through downtown and Lake Merritt, was constructed above ground through West Oakland, destroying West Seventh Street, which had been the commercial centre of the African American community.



1.16 General Strike 1946 - Protesters on Broadway



1.17 Business Elite - headed by Joseph Knowland, owner of the Oakland Tribune Newspaper



1.18 Main Oakland Public Library (1951)



1.19 Freeway Construction (1955)



1.20 Black Panther Party 'Free Huey' Protest (1968)

In 1966, college student Huey Newton and ex-military Eldridge Cleaver, employees of the North Oakland Neighborhood Anti-Poverty Center, a part of the federally funded Model Cities program, drafted the 10-point program of the Black Panther Party for Self-Defense. This outlined demands for a City response on issues such as joblessness, housing, and police brutality. The Panthers became widely popular for their positive contributions to the community, and for their “brash willingness to stand up to police.”²³ After a shootout between Panthers and the police, leader Huey Newton was imprisoned. Several urban communities rallied around the ‘Free Huey’ cause. The Black Panther Party, as a part of the Black Power movement, spread to other cities such as Los Angeles. In the mid-1970s the Party dissolved, in part due to irreconcilable conflicts between those who wanted to focus on political and community action, and those sought a more confrontational stance. As one historian described, “the party never resolved the ambivalence of its own identity as both an armed nationalist resistance movement and a community-based human rights organization.”²⁴ The Panthers can be viewed within a larger culture of protest that was alive on the West Coast at that time, particularly on the nearby U.C. Berkeley campus, where free speech, anti-war, civil rights, and feminist protests were taking place.

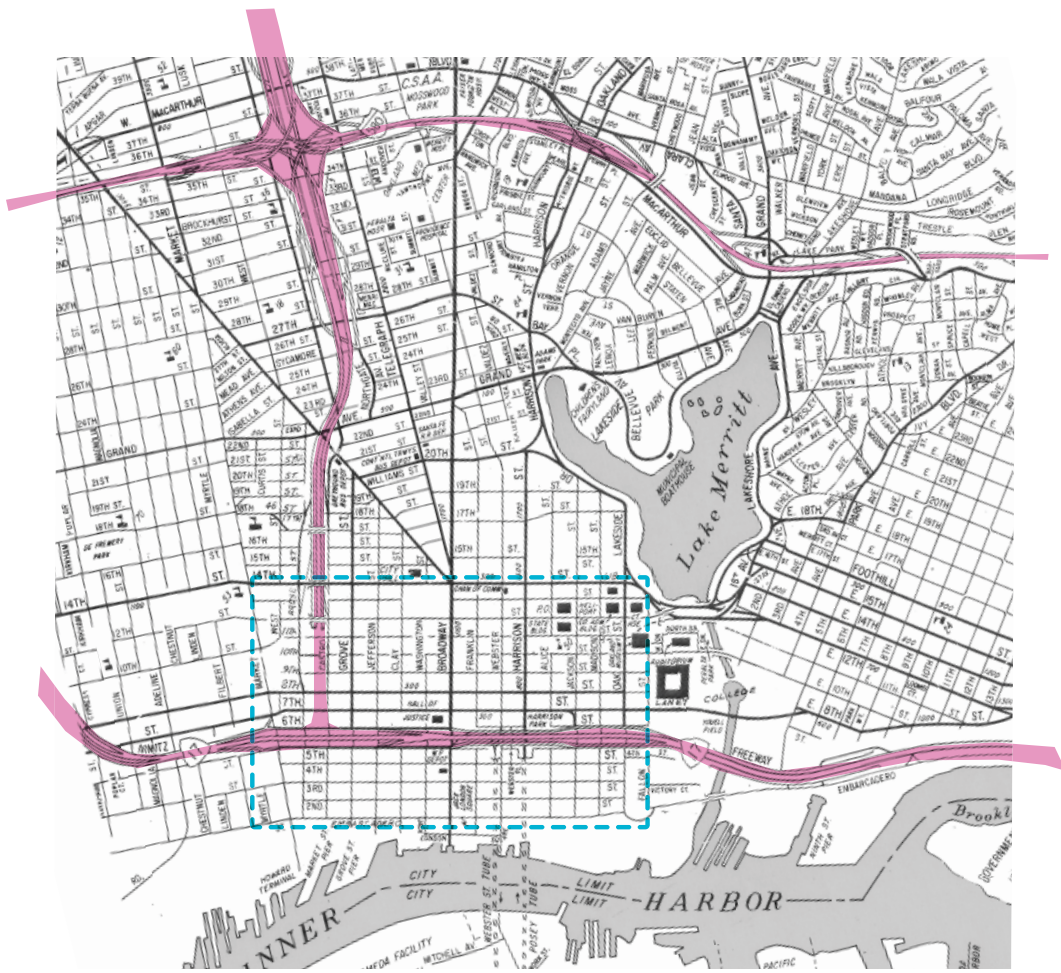

1.21 Downtown Oakland Plan (1985)

- Highways
- Extents of Original Plan

The middle classes continued to move out of downtown neighbourhoods, and by the late 1970s, as a result of declining tax dollars and political support, “the pillars of the old downtown elite had collapsed.”²⁵ In a weak economic climate, Lionel Wilson was elected mayor in 1977, and Oakland politics entered what has been called the “black urban regime”.²⁶ A year later, the State of California passed Proposition 13, which limited cities’ abilities to raise property taxes, and resulted in major cuts of programs and staff. During this difficult period, the Oakland Public Library system worked to expand service and respond to new populations. The Cesar Chavez branch was built in 1966 as the first library in California designed to serve the Hispanic population, and it was followed by the 1976 opening of the first Asian Branch. Other programs to serve special needs were formed, such as the bookmobile, an Adult Literacy program, and services for blind, visually impaired, and deaf patrons.²⁷

As public money dwindled, Mayors Lionel Wilson and later Elihu Harris attempted to attract capital to the city. The City Center Mall and Marriot Convention Center were built in downtown, yet many other projects failed due to declining investment. In 1989 the downtown was further damaged by the Loma Prieta earthquake, which has left many historic buildings standing empty to this day, in need of seismic upgrades. In 1990 the Jack London Square development was built, but after opening, it remained largely vacant for some time. In the mid-1990s, massive federal and state administration complexes were built west of Broadway. However, city government was fighting against difficult odds as businesses closed, joblessness increased, and the poorest neighbourhoods were devastated by major problems centred on poverty and the rising drug trade. After the middle classes (and any others who could afford to leave) vacated the downtown, public housing and other urban issues became foreign to their interests, as these issues were increasingly seen as ‘minority’ concerns.²⁸ As a result, “Fragmented by enduring structural inequalities ..., urban civil society proved too weak to keep opposing groups present together in a shared public sphere.”²⁹

In 1999, as the economy began to improve, former California governor Jerry Brown was elected mayor. He began the ‘10K’ program to bring 10,000 new residents into the downtown by 2010. Many projects, primarily market-rate multi-family residential buildings, have been built or are in the approval process (many of these were initiated during Harris’s previous term). As of January 2007, one thousand new housing units have been built in the



1.22 Renovated Paramount Theater



1.23 Renovated Victorians in Old Oakland

1.24 City Center Mall

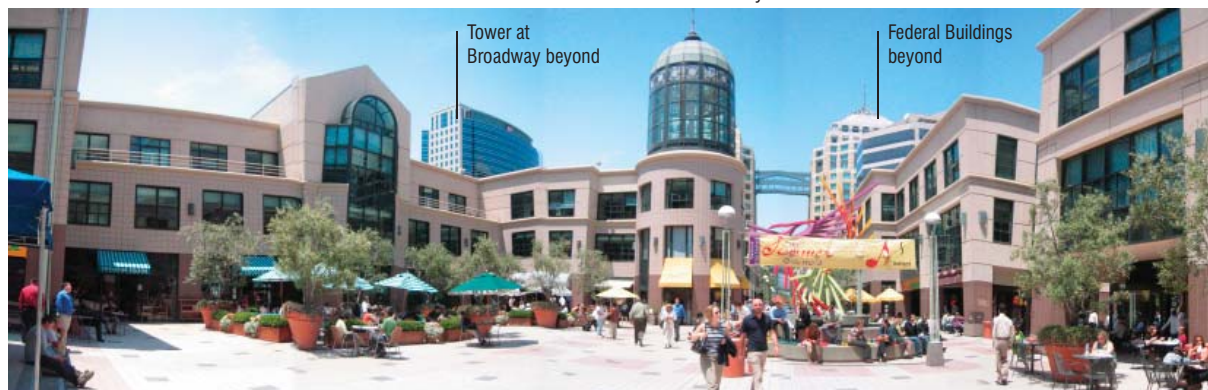

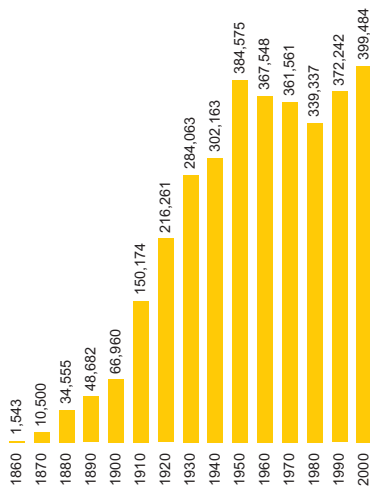

City of Oakland Population 1860-2000*
 Total: 399,484 people (1.18% of California Population)
 *data from decennial US Censuses

1.25 Oakland Population Growth

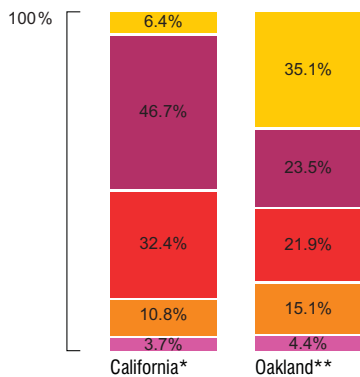

- Black or African American
- White
- Hispanic or Latino
- Asian
- Some other race

* California State Population (2000 Census)
 Total State Population: 33.8 million people (12% of USA Population)

** City of Oakland Population (2000 Census)
 Total City Population: 399,484 people (1.18% of California Population)

1.26 Oakland vs. California Populations

downtown, and 5,000 more are either under construction or have received approval.³⁰ Business, retail, and property investments have increased. As this occurs, rising rents have exacerbated the difficult situation of low-income residents, an estimated 80% of whom will not be able to afford a 2-bedroom unit in the new developments.³¹ Several historic buildings have been renovated, such as the Tribune Tower on 13th Street and the Rotunda building on Frank Ogawa Plaza. The Oakland Public Library recently proposed a bond to move the main library out of its inadequate current home, and into the Oakland Auditorium, but in 2007 the bond measure failed.

Now described as “remarkably diverse, tolerant, and culturally rich,” Oakland exemplifies the issues of the American downtown.³² It reflected the waves of economic boom and depression, wartime social change, and suburbanization which profoundly affected the urban culture of cities across the nation. Oakland was also the site of the formation of many powerful counter-publics such as the KKK, Labour unions, and Panthers, which acted in the public sphere, creating junctures in urban politics, and in some cases influencing the nation. Demographically a ‘majority-minority’ city, Oakland is representative of the projected future demographic of the United States.³³ It is home to a diverse public, and the downtown is gradually regaining its street life. Yet the city’s population is mapped out in a stratified and segregated way from the bay shore to the hills, and “all of the social consequences of four decades of segregated development” continue to profoundly affect developments in civic and institutional life.³⁴

Oakland has seen vast changes in its urban public life since its founding. As new investment picks up, and the middle classes begin to re-settle in the downtown which they left 60 years before, the social and economic distribution in the city is changing once again. Oakland forms an ideal context in which to question how a cultural and educational institution – specifically the communication-centred public library – can participate in urban culture. This city is an intriguing place to explore how the library can engage individual residents, and how it can contribute to an active, local, and multicultural public sphere.



1.27 Art and Soul Festival - Downtown Oakland (2006)

NOTES:

- 1 Roger F Urban. *Oakland: a Mediterranean City*. No Publisher: 1976, 48.
- 2 Beth Bagwell. *Oakland, The Story of a City*. Novato, California: Presidio Press, 1982. 26-7.
- 3 Ishmael Reed. *Blues City: A Walk in Oakland*. New York: Crown Journeys, 2003. 24.
- 4 Chris Rhomberg. *No There There: Race, Class, and Political Community in Oakland*. Berkeley: University of California Press, 2004. 28-39.
- 5 William Sturm and Steven Lavoie, "Oakland Public Library Historical Chronology 1878-2003," Oakland Public Library, <<http://www.oaklandlibrary.org/about/timeline.html>> (accessed June 12, 2007)
- 6 Rhomberg, *No There There*, 73.
- 7 Sturm and Lavoie, "Oakland Public Library Historical Chronology 1878-2003."
- 8 Rhomberg, *No There There*, 52.
- 9 Ibid, 55.
- 10 Ibid, 57-62.
- 11 Eric Avila. *Popular Culture in the Age of White Flight: Fear and Fantasy in Suburban Los Angeles*. Berkeley: University of California Press, 2004. 3.
- 12 Sturm and Lavoie. "Oakland Public Library Historical Chronology 1878-2003"
- 13 Bagwell, *Oakland, The Story of a City*, 85.
- 14 Marilyn Johnson. *The Second Gold Rush: Oakland and the East Bay in World War II*. Berkeley: University of California Press, 1993. p144
- 15 Ibid, 143-184.
- 16 Ibid, 168.
- 17 Ron Stewart (Oakland Blues Society) interviewed by Ishmael Reed March 1, 2003. In Reed, *Blues City*, 178.
- 18 Robert O Self. *American Babylon : race and the struggle for postwar Oakland*. Princeton, N.J.: Princeton University Press, 2003. 38.
- 19 Bagwell, *Oakland, The Story of a City*, 250.
- 20 Self, *American Babylon*, 138.
- 21 Johnson, *The Second Gold Rush*, 220.
- 22 Ibid, 214.
- 23 Marcia Eymann and Charles Wollenberg (Eds). *What's Going On? California and the Vietnam Era*. Oakland: Oakland Museum of California and University of California Press, 2004. 109
- 24 Rhomberg, *No There There*, 171.
- 25 Rhomberg, *No There There*, 183.
- 26 Ibid, 183.
- 27 Sturm and Lavoie, "Oakland Public Library Historical Chronology 1878-2003."
- 28 Johnson, *The Second Gold Rush*, 215.
- 29 Rhomberg, *No There There*, 179.
- 30 Kara Platoni and Robert Gammon. "Inflating the Numbers." *East Bay Express*, January 3, 2007. <<http://www.eastbayexpress.com/2007-01-03/news/inflating-the-numbers/>> (accessed August 12, 2007)
- 31 Rhomberg, *No There There*, 52-55.
- 32 Johnson, *The Second Gold Rush*, 240.
- 33 Farai Chideya. *The Color of our Future*. New York: William Morrow, 1999. 5.
- 34 Self, *American Babylon*, 3.

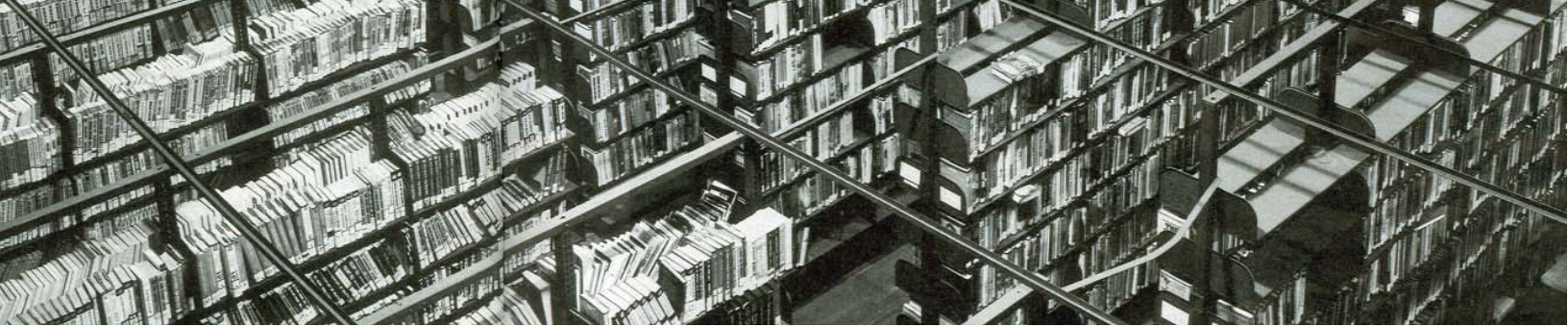

CHAPTER 2:

PUBLIC LIBRARY:

histories, roles, visions

As new populations and media technologies change urban culture in significant ways, public institutions such as the Library continually adjust to meet the public's needs and employ new tools. While shifting contexts demand change, they also open new opportunities for the Library to benefit a broader range of its public by expanding and strengthening its useful functions and symbolic meanings. This chapter explores some of these new opportunities, following two lines of inquiry: *Library as Public Space*, which explores the function and meaning of the Library as a public place in its urban context, and *Library as Communication Place* which considers the Library as a place and mechanism supporting a wide range of kinds, modes, and forms of communication. But first, to understand the municipal public library – which is both an institution of culture and education, as well as an urban social space – it is necessary to examine the public library's history and its idealistic mission.

A Brief History of the Municipal Public Library

a site for definition and contestation of culture

As an institution dedicated to the collection of human knowledge and art, the Library has inspired fantastical descriptions of its extraordinary qualities. Home to the book – the traditional point of entry into knowledge – the Library contains conceptually infinite possibilities for individual enlightenment and learning. Each book within the Library holds new ideas which can change a person's viewpoint entirely. Many have described a sense of immensity and awesome (or awful) presence created by so many pieces of information in physical form. Perhaps the most famous of these descriptions is the comparison of Luis Borges between the universal or infinite library and the universe itself.

When it was proclaimed that the Library contained all books, the first impression was one of extravagant happiness. ... As was natural, this inordinate hope was followed by an excessive depression. ... The impious maintain that nonsense is normal in the Library and that the reasonable (and even humble and pure coherence) is an almost miraculous exception.

... I suspect that the human species -- the unique species -- is about to be extinguished, but the Library will endure: illuminated, solitary, infinite, perfectly motionless, equipped with precious volumes, useless, incorruptible, secret.¹

In addition to housing this weighty multitude, the Library is a place of connection. Its texts make conceptual links which branch outwards to other eras, ideas and realities, and inwards through one's mind, as the images called up by the act of reading consolidate the physical structures of memory.²



2.2 Boston Public Library, the first public library in the United States (1859)

In the Western world, the idea of the public library was formed during the Enlightenment and later gained legitimacy, along with other social institutions, after the Industrial Revolution.³ In North America, the current form and idea of the public library as a widespread institution was largely defined by Andrew Carnegie's library-building campaign. Prior to this, several membership libraries and a few public libraries existed, yet it is Carnegie's extensive philanthropy which laid the foundation for the contemporary ideal of the municipal public library. From 1886 to 1929, the Carnegie Foundation granted capital for the construction of nearly 1,700 libraries in the United States.⁴ To receive a grant for a library's construction cost, a community was required to "provide a site and commit to tax itself 10 percent of the value of his donation annually for operations."⁵ The Carnegie Foundation also disseminated a philosophy for library service, and provided recommended standard plans – which resulted in the recognizable neo-classical facades which can be found in many cities. Carnegie's requirements were also significant in defining the library as a tax-supported public good (similar to parks, paving, and street lighting), tied to the fortune of its municipality. Also, Carnegie put library building into the hands of city business elites. Thus the process of locating central and branch libraries was often used for personal ends such as improving speculators' property values, and for political ends such as re-defining the symbolic center of power within the city fabric.⁶ While the Library is an institution ostensibly for the good of the general public, the insertion of private interests was not uncommon, as buildings have always been built and owned by the wealthy.



2.3 Woodcut from Jonathan Swift's 'Battle of the Books', a satire on the debate regarding whether modern writers could rival classical greats. The woodcut depicts classical and modern writers battling it out in the library. (1705)

The primary philosophy of the American public library has always been service.⁷ However, the question of purpose (and the means appropriate to serve it) has been the subject of heated debate since the institution's beginnings. In fact, the definition of 'valuable' material that the Library *ought* to collect and make available has been regularly contested; from the battle of 'ancients vs. moderns' in the late 1600s, to the 'fiction' question of the late 1800s, to the current conundrum of how the Library is to deal with multiple media and the Internet.^{8,9} Each of these earnestly fought battles was a struggle over the definition of culture, and over the Library's purpose as a cultural institution. In each of these conflicts, the side which opposed change saw 'traditional' culture being eroded by newly published works, as a wave of 'low-quality' texts flooded the Library. Cultural historian Lawrence Levine documents a similar dynamic of conflict in the context of curricular changes and public opinion toward the University in the United States. He notes that the most impassioned critics of change display a "paranoid style" of criticism; a belief that the changes are part of a conspiracy acting to erode "a nation, a culture, a way of life."¹⁰ This "paranoid style" of criticism can be seen in the vehement claims that 'book literacy' is dying (and with it, 'culture' and our ability to concentrate...), described in books such as *Data Smog* and *Gutenberg Elegies*, the latter of which fearfully proclaims, "what is roaring by, destined for imminent historical oblivion, is the whole familiar tradition of the book. Around us, already in place, are the technologies that will render it antiquated."¹¹

Illuminating the 'question of purpose', Alexis McCrossen describes the ambivalent position of librarians in the late 1800's, noting that "Whether mired in anxieties about idleness or steeped in aspirations for uplift, public librarians understood their work as being in opposition to and in competition with commercial, mass culture."¹² This statement might be less pertinent today, yet it articulates basic relevant questions: "what, *and more subtly, whom*, is the Library for?", "how is the Library to be good?" and "what position does the Library hold relative to commercial mass culture?"

The library has always been a site of definition of culture. This becomes especially interesting when the library is public, as service to this heterogeneous group raises difficult questions about what definition of 'culture' will hold meaning for all. In contemporary discourse, the concept of *the public* is increasingly seen as fractured and multiple, rather than unified. What does this mean for a public institution with a stated objective to serve all?

One response to the 'question of purpose' is put forward in the IFLA/ UNESCO Public Library Manifesto (adopted by the American Library Association). This statement of ideals describes the Library's purpose, and defines the public library as an institution crucial to the workings of a democratic society;

Freedom, prosperity and the development of society and of individuals are fundamental human values. They will only be attained through the ability of well-informed citizens to exercise their democratic rights and to play an active role in society. Constructive participation and the development of democracy depend on satisfactory education as well as on free and unlimited access to knowledge, thought, culture and information.

The public library, the local gateway to knowledge, provides a basic condition for lifelong learning, independent decision-making and cultural development of the individual and social groups.¹³

The Manifesto continues by describing virtues such as "equality of access for all," "relevance to local needs," and by stating that collections "should not be subject to any form of ideological, political or religious censorship, nor commercial pressures." In defining the public library's mission, the Manifesto includes "providing opportunities for personal creative development," "promoting awareness of cultural heritage," "fostering inter-cultural dialogue and favouring cultural diversity," and "supporting the oral tradition."¹⁴

Concurrent with these egalitarian statements of ideals, however, the library has recently been subject to scrutiny and criticism, similar to that which has been aimed at other public institutions. Cultural historians have described the Library's purpose, in various periods of history, as one of social control and cultural dominance.¹⁵ Critical statements have been made that the library in its early history was intended as a stabilizing institution to placate the working classes, and that in its program of 'uplift' for the masses, took bourgeois cultural norms and legitimized them as the 'correct' goal to which all should aspire.¹⁶



2.4 Library photo entitled: Handelingenkamer Tweede Kamer der Staten-Generaal Den Haag III (by Candida Höffer, 2002)

Throughout its history, the library has continuously evolved, changing its purpose and mission to reflect the politics and social conditions of the times. These changes reflect a struggle between utopian ideals and the social contexts in which the library finds itself.

As the multicultural nature of society in the United States is increasingly recognized, the idea that culture should be defined by the dominant group is no longer satisfactory. It seems crucial to consider the library as a place of cultural contestation or negotiation, rather than a site of cultural definition 'from above'. At the same time, rapid technological and societal changes are affecting the ways libraries can facilitate action in the cultural realm. New digital media and communications infrastructures are changing library services and the ways that people work, play, and act in public space.

The object of this study is the central, or downtown public library, which must serve the needs of all the communities and individuals in the city, as well as meeting specialized needs not fulfilled by branch libraries. By virtue of its location and usually its size, the downtown library also has potent symbolic potential and acts as a place for contact between the diverse individuals and communities within the city.

This chapter broadens the discussion about the role of the library, uncovering ideas which inform the design proposal (presented in Chapter 3). The first approach situates the library in the context of the city, as a public space and program with a mission to serve all and generally improve city life. The second approach conceives the library as a place of communication in its broadest sense, thereby inviting a wider diversity of social interactions and modes of communication into the library.

Urban Library as a Public Space

To discover new possibilities for the Library, this section explores its function as a public space, related to city parks, squares and sidewalks. The Library is unique – it is the most public interior space in our cities. It is more functionally used and useful to urban individuals than ‘representative’ public buildings such as City Hall, and more broadly inclusive of all (regardless of income) than shopping malls, yet it is still an interior space, which enforces a certain behavioural code upon its visitors. Asserting the intensely public nature of the library allows us to draw on theories about the nature and use of public space to inform the proposal for a new urban public library.

the library as an active part of the ‘public sphere’

In thinking about social action in public space, one of the most influential modern theories is the concept of the ‘public sphere’ described by Jürgen Habermas in *The Structural Transformation of the Public Sphere*.¹⁷ In this history of what Habermas saw as a *new* form of political action, he chronicled the rise in the 1700s of the ‘bourgeois public sphere’ located in the physical place of the coffeehouse, and the virtual space of the literary journals of the day. He proposed that this public sphere was a space where people could discuss issues of common concern, where “political participation is enacted through the medium of talk,” in a space separate from both the state and the economy, and distinct from the private realm of the household.¹⁸ The ‘bourgeois public sphere’ is historically situated in the rise of a merchant class and the early development of democracy in Europe; and Habermas explains that with the rise of mass democracy and mass media, this instance of the public sphere disintegrated.

Since Habermas, the concept of the public sphere has been reconsidered by many theorists. Nancy Fraser suggests that something akin to the public sphere described by Habermas “is indispensable to critical social theory and democratic political practice.”¹⁹ Fraser identifies several problematic assumptions in Habermas’s concept of the public sphere, and concludes that in a stratified society such as our current one, it is most effective (in furthering the aims of democracy) to have a diversity of “subaltern counterpublics” which accommodate the groups excluded from the “dominant” public sphere.²⁰ In considering whether any *unified* zone of discussion and contestation can exist, she references Geoff Eley’s notion that “we think of the public sphere [in stratified societies] as ‘the structured setting where cultural and ideological contest or negotiation among a variety of publics takes place.’”²¹

This concept of a structured setting where multiple ‘publics’ can come together, communicate, and represent their ideas seems to describe a valid purpose for the library in multi-cultural and socially unequal cities. In fact, many library theorists connect Habermas’s ‘public realm’ to the library, one example being the recent collection of essays in *The Library As Place: History, Community, and Culture*.²² This idea is also aligned with the description of the Library’s mission of “fostering inter-cultural dialogue and favouring cultural diversity,” and its ideal of “equality of access for



2.5 London Coffeehouse 1700's

all, regardless of age, race, sex, religion, nationality, language or social status.”²³ Indeed, the very basis of democracy as a political system ‘fair to all’ is based upon the concept of the public sphere, the idea of “well-informed citizens [exercising] their democratic rights.”²⁴ The notion of a place for a ‘variety of publics’ to come together seems particularly relevant for the library in Oakland; where many strong manifestations of ‘civil society’ (service clubs, PTAs, church groups, arts programs, and volunteer social services) thrive, yet where segregation has polarized society along race and class lines, and tended to prevent these diverse groups from finding common ground.

the library as a setting for ‘contact’

Another idea from the social sciences that inspires a new vision for the library is described in the recent compilation ‘Giving Ground: The Politics of Propinquity’. This collection of essays holds many different attempts at describing the effects and benefits of ‘propinquity’ or neighbourliness in the city – an effect of the diversity and density of people and activities in a lively, mixed-use urban area.²⁵ This concept was described by Jane Jacobs, who theorized about the positive effects of ‘eyes on the street’, and the effect of diversity (of building age and use) in creating lively neighbourhoods with a network of individuals who have a particular kind of concern for their shared public spaces.²⁶

In his article “...*Three, Two, One, Contact: Times Square Red, 1998*”, Samuel Delaney further develops Jacob’s term ‘contact’, using it to describe the specific kind of social relations which rest on diverse and mixed-use urban spaces.²⁷ Delaney’s thesis contrasts ‘contact’ and ‘networking’ (two types of social interaction with distinct purposes and effects), and considers the kind of urbanism required to support them. ‘Contact’ he describes as the seemingly random interactions that occur between people in a dense, diverse city. Delaney illustrates how contact often occurs across class and race boundaries, and how the urban diversity (both programmatic and social) which promotes contact “stabilizes the quality of life and long-term viability of the social space” of the city.²⁸ ‘Contact’ can also sometimes yield great benefits for those involved, because as it occurs between classes, the participants are more able to extend favours which might be small to one, but significant to the other. ‘Networking’, on the other hand, describes the kind of interactions that occur in more structured settings (e.g. conferences) where one could reasonably expect to meet people of similar interests, class, or profession – who often have similar needs. In Delaney’s description, a networking situation often includes many people who are in competition for the same scarce resources; thus while it has its place in social relations, it is less likely than a ‘contact’ situation to yield large rewards. Delaney describes personal ‘contact’ experiences in which he randomly connected with strangers on a city street over a sighting of comet Hale-Bopp, noting of the interactions that “Their only fallout is that they were pleasant – and that pleasantness hangs in the street under the trees ... near which they occurred, ... [and] that fallout will remain as long as I remain comfortable living here.”²⁹

the library as a lively urban place

The idea of ‘contact’ is useful for understanding the hard-to-quantify benefits of bustling, successful urban public spaces. To understand the design of such spaces, empirical studies of public space use are valuable. Famous among these is William Whyte’s *The Social Life of Small Urban Spaces* (1980), which documented the use of public plazas and parks in downtown New York. Whyte found that some factors which make an urban public space popular are sitting space, pleasant microclimate, food, and convenient relationship to the street. This study was so influential that some of these factors were incorporated into the New York City zoning bylaws.³⁰ Also working to revitalize public spaces is Project for Public Spaces (PPS), a consulting group which partners with city governments and other agencies to help define and improve urban places.³¹ Their document *What Makes a Great Place* draws on many of the ideas highlighted by Whyte. It suggests that ‘great places’ have four key attributes, which can be measured by the presence or absence of indicators. The four key attributes are “Sociability, Uses & Activities, Access & Linkages, and Comfort & Image.” Sociability, for example, can be measured by studying the “number of women, children & elderly” present, the “social networks” related to the space, “evening use” and “street life.” “Access & Linkages” can be measured by “pedestrian activity”, “parking patterns,” and “transit usage.”³² The recent book *Rethinking Urban Parks: Public Space and Cultural Diversity* also focuses the design of public spaces, specifically on how to encourage social diversity in urban parks. The authors suggest that to maintain diversity in city parks, it is important for people to feel that their history and culture is represented in the place (or not erased), and that “safe, spatially adequate territories for everyone within the ... overall site” be provided to promote interaction between diverse user groups. They also stress that “accommodating the differences in the ways social class and ethnic groups use and value public sites is essential to making decisions that sustain cultural and social diversity.”³³ These ideas form a set of practical strategies and goals which are drawn upon by the design proposal.



2.6 Busy Urban Public Space - Walmán Rink, Central Park, New York

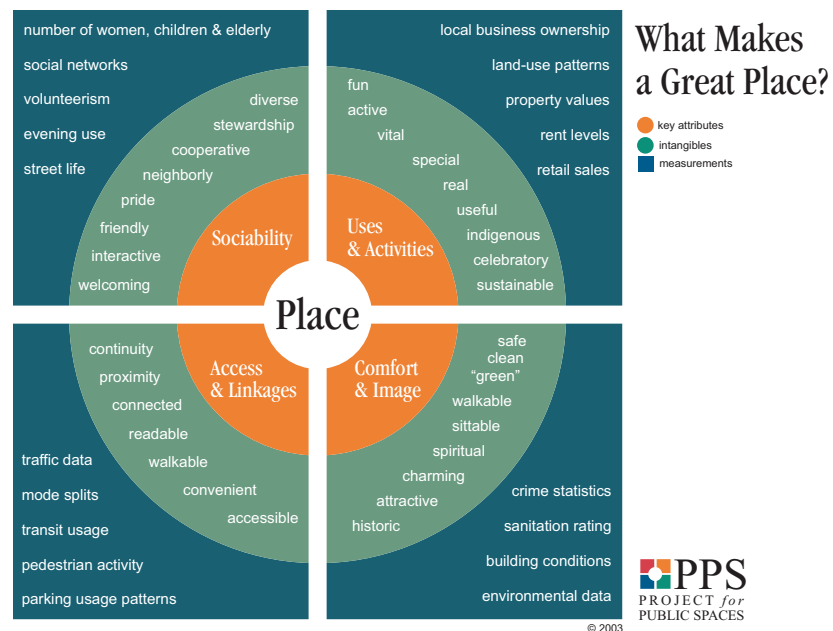

2.7 “What Makes a Great Place” - Project for Public Spaces

Urban Library as a Place of Communication

The Library gathers, stores, and provides access to information, thereby transmitting communications between people of different eras, cultures, and ideologies. At the same time, as described above, the Library is an urban social space. Therefore it could be said that communication, in a broad sense, is the social action upon which the library is founded. This idea forms a second line of inquiry for rethinking the library. By focusing on communication (the interaction or exchange) rather than on media (the specific object or means which enables communication), the concept of library function can be broadened to include a wider range of social situations. New developments in communication technology and the resulting cornucopia of mainstream media forms are opening new possibilities for library service, and social interactions within the Library. As new medias and technologies challenge the primacy of the book (shifting the functional foundations of library service), the institution must recognize and focus on its social functions.

expanding variety of media and means of communication

Since the beginning of the modern public library, the dominant media in the library have been books and other printed materials. The structure of communication in the book-centered library is primarily one-way and non-interactive; after publishing and library purchasing processes, communications deemed worthy appear on shelves and become available to individual readers. Since the book, there have been developments in 'mass' or 'broadcast' media such as radio, newspapers, and television. The broadcast model transmits a single source to a large, distant and dispersed audience, whose power is limited to choosing among a small number of 'channels'. With the advent of the Internet, the multiple media of sound, image, video and text have been digitized and woven into a hyperlinked, interactive media environment. Using this infrastructure, nearly anyone can 'serve' content, which opens up new possibilities for anyone to 'publish' their work and make it available to a large audience in ways which previously were not possible. In this environment, new means of communication are emerging; for example e-zines, blogs, wikis, content-sharing communities such as *Youtube.com*, and social networking websites such as *Myspace.com*. These mechanisms serve people's desires to communicate, creating venues for scholarly discussion, fleeting gossip, and everything in between.

The developments in recording technology brought a wider range of human senses into interaction with media. This ushered a broader segment of all the possible modes of human communications into the realm of recorded media; this meant that communications which previously were quite ephemeral could now be recorded, shared across great distances, and stored for posterity. The new ability to record also meant that forms of communication which had been part of informal, day-to-day, folk culture (such as popular music), increasingly entered the realm of copyright, and could be owned to the profit of a sole author.

The shift from the book (disseminated via publishing) to recorded sound and video (disseminated via broadcasting), and now to the digitization of all of these media and their accessibility via the Internet, has changed the relationship between authors and audiences. This change has triggered new dynamics; for example the collective authorship happening on sites like Wikipedia.org, the hugely increased individual authorship represented by blogs, and community sites such as *Archinect.com* which combine professionally authored information with community participation and authorship by amateurs. In short, the range of ways that one can participate in the usage and production of information and artistic work (which can be made widely and publicly available) has expanded with the advent of the Internet and relatively accessible digital tools and software.

social contexts of media use

The social context of people's use of media has also changed with the introduction of multiple media. While books can be enjoyed in a group through storytelling, reading is typically an individual activity which requires concentration. In contrast, film, music, and multimedia products lend themselves well to being experienced in public, and in fact are central to a significant portion of social outings in the city. By developing the library as a space for the enjoyment of music, film, poetry, performance, and art, in addition to books, the possibilities for social interaction can be expanded by these media *events*.

Increasingly, these new forms of media are being seen as legitimate cultural and artistic products. This means that a wider range of creators can be seen as legitimate authors, and it also means there is increased freedom in choosing the medium by which one takes in information. In this context, the library has an opportunity to be a place for musical performances, video/multimedia screenings, a local radio station, and local artistic events and projects. These changes hold the potential to make the library a more diverse and active space of communication, by creating more options for the public's use of the institution, and creating links beyond the library to community arts and media organizations. These organizations are not typically focused on the book, but bring people together around music, film, and artistic and community development projects. Oakland has a vibrant arts and community education scene, which may be overlooked for having few 'official' contexts in which to gather. The library could benefit by becoming a gathering place of this kind, and by inviting local media-related programs to a common, officially legitimized space.

The recent advent of the Internet, cell phones, and other wireless devices also changes the social context of media use by bringing it out of the home and office and into parks, city streets, and coffee shops. This new dynamic of seemingly private actions pursued in public engages more people, in new ways, within the public realm of the city.



2.8 Reading



2.9 Storytelling



2.10 Music / Video performance



2.11 Spoken Word performance

communication in physical space

As new media and communications infrastructures (specifically the Internet) have become mainstream, the online library has come into being. This has raised the question of whether the library needs to exist in public space at all. As the techno-romantic William Mitchell has suggested, the online library could be more accessible, with longer opening hours and more easily searchable information. He also suggests that the digital library and 'online community' could be more egalitarian than that of the physical city.³⁴

However, the potential for communication that can be offered by a physical public library is fundamentally different than that which can be offered by an online library. Neither can be a substitute for the other. There are functions, such as sustained reading, for which the printed book is superior, yet digital information offers many benefits in terms of ease of access and manipulation.³⁵

Physical public space (especially that sited in a lively downtown of a multi-cultural city) offers the potential of 'contact' between strangers in a way that the Internet does not. Physical public spaces also allow a much greater variety of communication methods than the Internet does. Research indicates that "the total impact of a message is about 7 percent verbal (words only) and 38 percent vocal (including tone of voice, inflection, and other sounds) and 55 percent nonverbal."³⁶ It is clear that between people, body language constitutes a huge percentage of communications – and most of this spectrum of communication is not represented in Internet communications. In physical space, ambiguities can be understood through context, tone of voice, gesture, posture, eye movement, and facial expression – through body language which engages more than just our conscious minds. There is a multifaceted richness of information exchange that occurs in face-to-face interactions, while on the Internet communication is simplified down into a single mode, primarily typing (though audio and video are becoming common). There is also a wide range of more passive communications which occur in space, for example observing (such as people watching) and performance (through walk, actions, dress, and attitude).

Beyond the Library's practical function of providing access to information, the social interactions and opportunities generated by the Library's existence as an urban public space are crucial to the institution's continuing success. If these 'side effects' are taken into serious consideration, and incorporated into the mission of the Library (as parts of the IFLA/UNESCO Public Library Manifesto seem to suggest), they lead to a richer appreciation of the importance of the library within our cities, and its potential for improving city life.³⁷



2.12 Outdoor Seating in Oakland's City Center Mall - people sitting, eating, talking, reading

Vision of the Public Library : Urban Communication Space

How are these concepts about public space and communication relevant to the design of the Library in a multi-cultural city such as Oakland? How can the urban public library strengthen the useful functions and symbolic meanings which it holds for its diverse public? The roles of the Library are multiple and rich – this can be seen in the way public libraries are used, and in the ideals of the IFLA/UNESCO Public Library Manifesto. The multiple roles recognized and explored in this chapter suggest that the activities and spaces which the building contains must be similarly multifaceted.

Considering the Library as an urban public space (beyond its functional role as an information store) unlocks the potential for a wider range of social interactions which the building can host. The Library can be a more active venue for many kinds of social exchange, from casual meetings (random ‘contact’ between individuals), to more organized gatherings (of social networks and community organizations). To support these social activities, a diversity of programs is required. These diverse programs could make the library more popular and appealing to Oakland residents.

Considering the Library as a place for a broad range of communication types (beyond books and reading) also situates the Library’s social function as central in a renewed vision for the library. The contemporary cornucopia of media types and technologies expands the possibilities for experiencing media in public. The Library can exploit these media technologies to facilitate many kinds of social situations in which learning, leisure, information seeking, artistic creation and performance can occur. The inclusion of venues for media creation and presentation could make the Library a place where media is produced as well as consumed. These venues for discourse would make the Library a place where culture is not only defined and legitimized, but also contested – a crucial distinction in a multi-cultural and unequal society. This diversity of social situations involving communication media could engage a wider variety of Oaklanders in this shared space.

This broadened vision of the Library’s purpose, media and programs could make it a social space which enriches urban life – by promoting contact between individuals and by supporting community groups. These adjustments could strengthen the Library’s usefulness and meaning for Oakland’s diverse public.

NOTES

- 1 Luis Borges. *The Library of Babel. Labyrinths : Selected Stories & Other Writings.* Translated by James E. Irby. New York : New Directions Pub. Corp., 1964. <http://jubal.westnet.com/hyperdiscordia/library_of_babel.html> accessed 07-06-18
- 2 George Johnson. *In The Palaces Of Memory: How we Build the Worlds Inside Our Heads.* New York: Knopf, 1991. 20
- 3 A.S. Popowich. "The Politics of Public Library History." *Dalhousie Journal of Information & Management*, Vol.3, No.1 (Winter 2007) <http://djim.management.dal.ca/issues/issue3_1/popowich/index.htm> accessed 07-06-15
- 4 Akst, Daniel. "Do Libraries Still Matter?" *Carnegie Reporter*, Vol.3, No.2 <<http://www.carnegie.org/reporter/10/books/index3.html>> accessed 06-07-29
- 5 Ibid.
- 6 Abigail Van Slyck. *Free to All: Carnegie Libraries and the Transformation of American Culture, 1886-1917.* Doctor of Philosophy Dissertation, University of California, Berkeley. 1989. 146-244.
- 7 Popowich, "The Politics of Public Library History."
- 8 Matthew Battles. *Library: An Unquiet History.* New York: W.W. Norton & Company, 2003. 88-93.
- 9 Alexis McCrossen. "'One Cathedral More' or 'Mere Lounging Places for Bummers'?" *The Cultural Politics of Leisure and the Public Library in Gilded Age America.* *Libraries & Culture* 41.2 (2006). 169-188.
- 10 Lawrence Levine references Richard Hofstadter's concept of 'paranoid style' in *The Opening of the American Mind: Canons, Culture, and History.* Boston: Beacon Press, 1996. 30.
- 11 Swen Birkerts. *The Gutenberg Elegies: The Fate of Reading in an Electronic Age.* Boston: Faber and Faber, 1994. Also David Shenk. *Data Smog: Surviving the Information Glut.* New York: Harper Collins, 1997.
- 12 McCrossen, "One Cathedral More," 170.
- 13 IFLA/UNESCO Public Library Manifesto – 1994. International Federation of Library Associations and Institutions (IFLA) Website. <<http://www.ifla.org/VII/s8/unesco/eng.htm>> accessed 06-08-23. (for full text, see Appendix A)
- 14 Ibid.
- 15 Popowich, "The Politics of Public Library History."
- 16 Ibid. Also Alistair Black. *A New History of the English Public Library: Social and Intellectual Contexts, 1850-1914.* London: Leicester University Press, 1996.
- 17 Habermas, Jurgen. *Structural Transformation of the Public Sphere: A Category of Bourgeois Society.* Translated by Thomas Berger. Cambridge, Mass: MIT Press, 1989. Originally published as *Strukturwandel der Öffentlichkeit* in 1962.
- 18 Nancy Fraser. "Rethinking the Public Sphere: A Contribution to the Critique of Actually Existing Democracy." *Social Text*. No 25/26 (1990), 56-80.
- 19 Ibid, 57.
- 20 Ibid, 66.
- 21 Geoff Eley. "Nations, Publics, and Political Cultures". *Culture / Power / History: A Reader in Contemporary Social Theory.* Princeton, NJ: Princeton University Press, 1994. Referenced in Fraser, "Rethinking the Public Sphere," 68
- 22 Buschman, John E., and Gloria J. Leckie eds. *The Library As Place: History, Community, and Culture.* London: Libraries Unlimited, 2007.
- 23 IFLA/UNESCO Public Library Manifesto – 1994. (Appendix A)

- 24 Ibid.
- 25 Micheal Sorkin, and Jean Copjec, eds. *Giving Ground: The Politics of Propinquity*. London: Verso, 1999.
- 26 Jacobs, Jane. *The Life and Death of Great American Cities*. New York: Random House, 1961.
- 27 Delaney, Samuel R. "...Three, Two, One, Contact: Times Square Red, 1998." *Giving Ground: The Politics of Propinquity*. London: Verso, 1999.
- 28 Delaney, "...Three, Two, One, Contact," 69.
- 29 Delaney, "...Three, Two, One, Contact," 71-72.
- 30 Whyte, William. *The Social Life of Small Urban Spaces*. New York: Project for Public Spaces, 1980.
- 31 Project for Public Spaces <<http://www.pps.org/>> accessed 07-08-15.
- 32 'What Makes a Great Place' Project for Public Spaces website: <<http://www.pps.org/info/placemakingtools/>> accessed 07-08-15.
- 33 Setha Low, Dana Taplin, and Suzanne Scheld. *Rethinking Urban Parks: Public Space and Cultural Diversity*. Austin, Texas: University of Texas Press, 2005. 4-5.
- 34 Mitchell, William J. *City of Bits: Space, Place and the Infobahn*. Cambridge, MA: MIT Press, 1996.
- 35 Michael Buckland. *Redesigning Library Services: A Manifesto*. American Library Association, 1992. <<http://sunsite.berkeley.edu/Literature/Library/Redesigning/html.html>> accessed 07-06-02
- 36 Albert Mehrabian quoted in *The Definitive Book of Body Language* by Allan and Barbara Pease. New York: Bantam Books, 2004. 9.
- 37 IFLA/UNESCO Public Library Manifesto – 1994. (Appendix A)
- 38 Ibid.



3.0 Downtown Oakland Aerial Photo

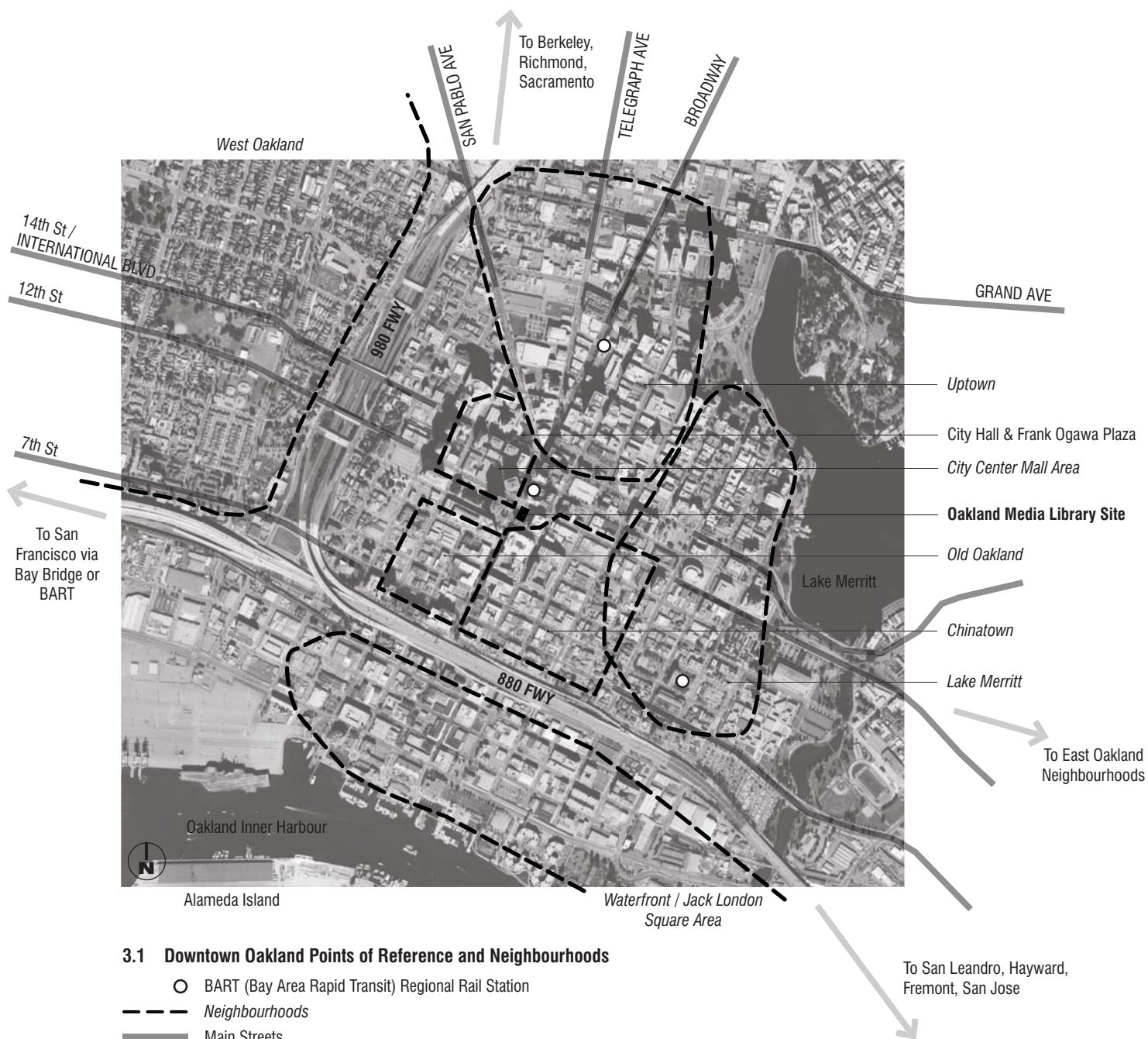

CHAPTER 3 : Proposal : Oakland Media Library

URBAN NETWORKS :

Infrastructures, Open Spaces, Cultural Agencies

With a railway terminus and deep-water port, Oakland has always been crucial to the Bay Area's prosperity. It has historically been the second largest city in the region after San Francisco (although now it is third after San Jose). The city's proximity to the Bay Bridge makes it the eastern gateway to San Francisco and a traffic funnel for most of San Francisco's East-Bay commuters.

Despite its ideal climate and location, Oakland has been overlooked by investors until recently, for various social, political and economic reasons. This has been changing since the late 1990s, as residential and commercial development has dramatically increased. The Oakland Media Library proposal is in part inspired by the opportunity (or imperative) to build in the public realm as developers rapidly build in the private realm. It is a proposal for a downtown public place and amenity which will serve the existing population as well as the new, and will be a place for the diverse public as the city undergoes a period of transformation.

Bounded by water on two sides, downtown Oakland has views to the Contra Costa Hills and the San Francisco peninsula across the bay. A mild climate allows year-round use of the city's outdoor spaces. These spaces fall into three categories: block parks, larger 'landscape' parks, and urban plazas. One example of a hybrid of these types is the Oakland Museum, which has a walled garden and a terraced roofscape over its galleries.¹ However, despite the pleasant weather and views, rooftop public spaces are uncommon in Oakland, in contrast to neighbouring San Francisco. In downtown San Francisco, raised plazas form another layer in the dense network of pedestrian places. They offer novel perspectives from which to view and understand the city, and improve daily urban life.

With a rich history of local organization and action, Oakland continues to be a vital site for community formation and activism. This vitality is evident in the city's arts scene and many associated community-education groups. This scene has been described as 'down-to-earth, community-oriented'.² Art Murmur, a monthly gallery event, draws crowds out to Uptown Oakland galleries and cafés. Near Lake Merritt are more formal cultural and educational institutions including Laney College and the existing Oakland Main Library. West Oakland is home to schools, music and art venues, and a nascent 'Village Bottoms Cultural District', near the historic gathering place of the city's African-American community.³ Music venues, galleries and museums can also be found near Jack London Square and in Old Oakland. Within this context, the proposed Oakland Media Library is envisioned as a place where formal institutions like public schools and colleges can make connections to more informal arts groups like the Rock Paper Scissors Collective. It is envisioned as a place where community groups can present their projects to the public at large, increase their visibility, reach a larger audience, and thus extend their positive effects.



3.2 Central Business District - view Southward along Broadway



3.3 Downtown Oakland Cultural / Educational / Arts Venues

- Public Libraries (Oakland Public Library System)
- Educational Facilities - Schools and Colleges
- Visual Arts Venues - Museums, Galleries, Arts Education Programs, Theatres
- Music Venues - Bars, Clubs, Theatres



3.4 Bay Area Rapid Transit (BART) System Map

Connections to North Oakland and Hills Neighbourhoods, Berkeley, Richmond, Vallejo



To San Francisco via Bay Bridge or BART

Upper Broadway & Grand Avenue Shopping Areas: restaurants, bars, galleries, shopping busy days, evenings and weekends

BART 19th Street Station

City Center Mall / Frank Ogawa Plaza: Shopping and Office Area, busy during daylight hours

BART 12th Street 'Downtown' Station

Oakland Media Library Site

Old Oakland and Chinatown Areas: Shopping, restaurants, bars, busy during workday and evenings

BART Lake Merritt Station

Connections to East Oakland Neighbourhoods

Waterfront / Jack London Square Area: some shopping, tourists, and ferry traffic during the day, restaurants and bars during evenings

Connections to San Leandro, Hayward, Fremont, San Jose

3.5 Downtown Oakland Transportation Network and Pedestrian Use Areas

- BART (Bay Area Rapid Transit) Rail Lines - Underground in Oakland Downtown
- AC (Alameda County) Transit Bus Lines
- Freeways
- BART Stations
- Areas more heavily used by pedestrians - with restaurants, bars, shopping, offices.
- Walking & Biking distances



3.6 Downtown Oakland Open Space and Recreation

- Green Space Parks (Grass, Trees, Playgrounds, Gardens)
- Open Spaces (Public Plazas, Private Plazas, other residual pedestrian spaces)
- Bodies of Water
- Explicitly designed Pedestrian Axes / Paths



3.7 Lafayette Park - 'Block Park' - Lafayette Park is one of the original block parks included on the 1850 Plan of Oakland. It was recently redesigned by Walter Hood.



3.8 Lake Merritt - 'Landscape Park' - Lake Merritt is one of the boundaries of Oakland's downtown. The lake was created by the infill of the mouth across the original salt marsh. The park takes its name from early mayor and landowner, Samuel Merritt, who donated the land to the city in 1869. In the 1920's, it was landscaped and made into a park, and has undergone various renovations since then.



3.9 Frank Ogawa Plaza - 'Urban Plaza' - Oakland City Hall, and the renovated 'Rotunda building', originally home to the Kahn's department store, face onto the plaza. Originally, San Pablo Avenue ran through the space to meet Broadway, but the street has since been closed to expand the plaza.



3.10 Oakland Museum - 'Hybrid' - Green space and hardscape combine to form a rooftop terraced garden over galleries. Oakland Museum was designed by Kevin Roche John Dinkeloo and Associates, built in 1968, over four blocks near Lake Merritt.

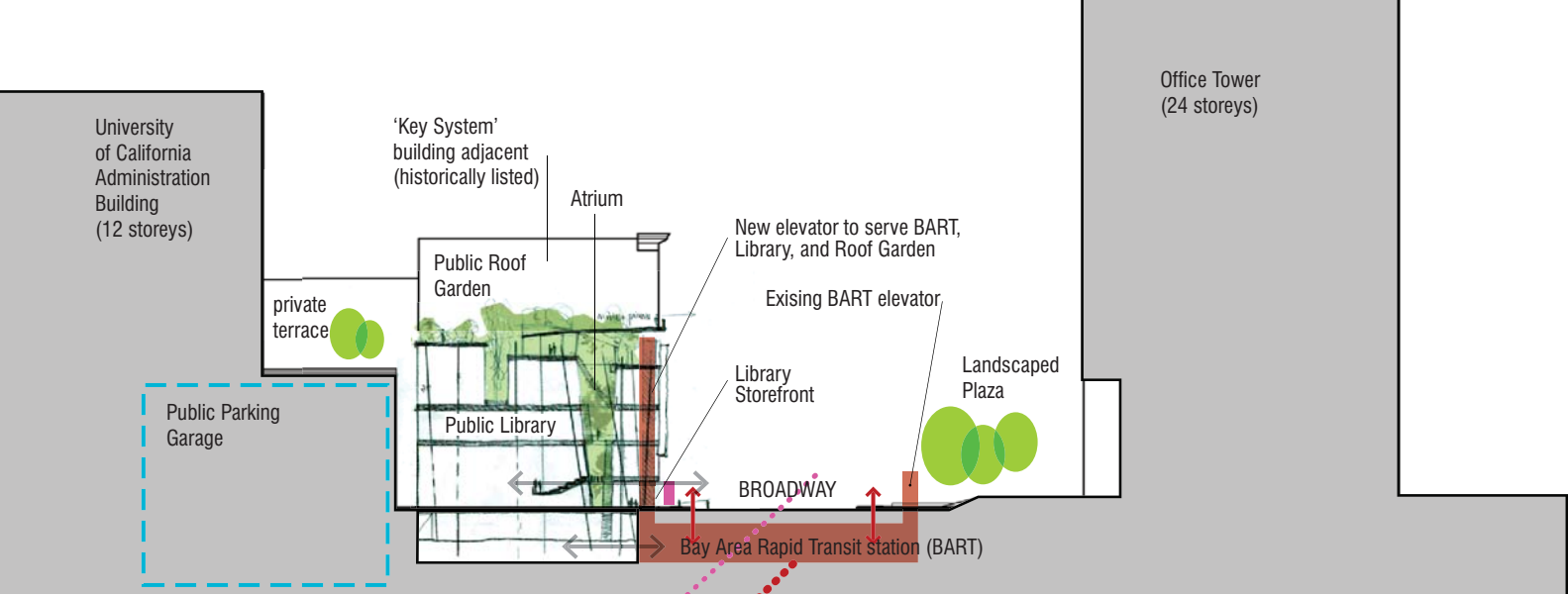

3.11 Site Section across Broadway - relationships to transit and street life Scale 1:1000



3.12 Surrounding Urban Context

- Open Spaces and Pedestrian Paths
- BART entry, station, route
- Bus Routes and Stops
- Public Parking areas
- Cultural Institutions
- Site Photos - see p 9



3.13 Site Photo A - From 11th and Broadway



3.14 Site Photo B - from 12th and Broadway

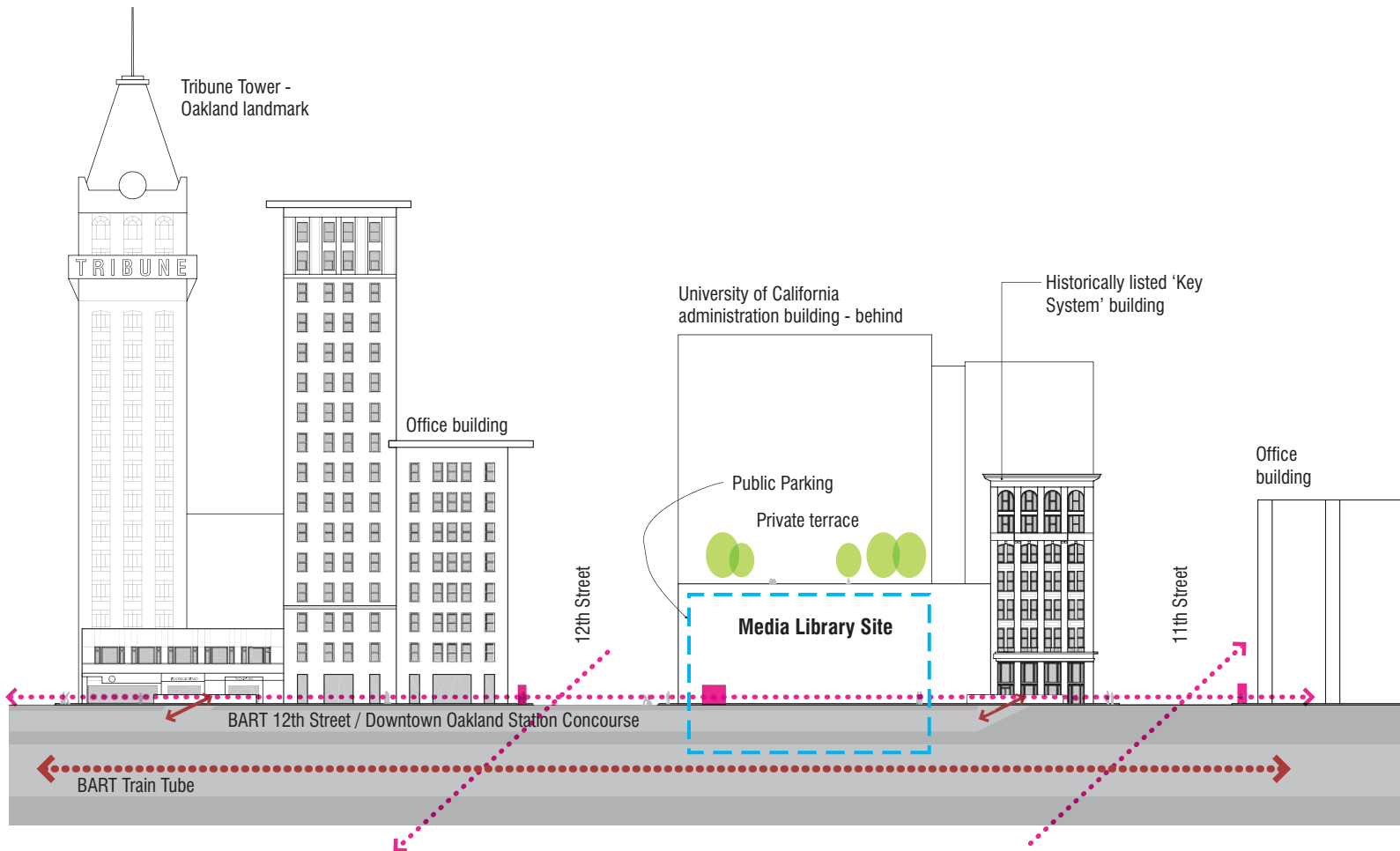

3.15 Site Elevation (Broadway)

Scale 1:1000



GARDEN



LIBRARY



STOREFRONT

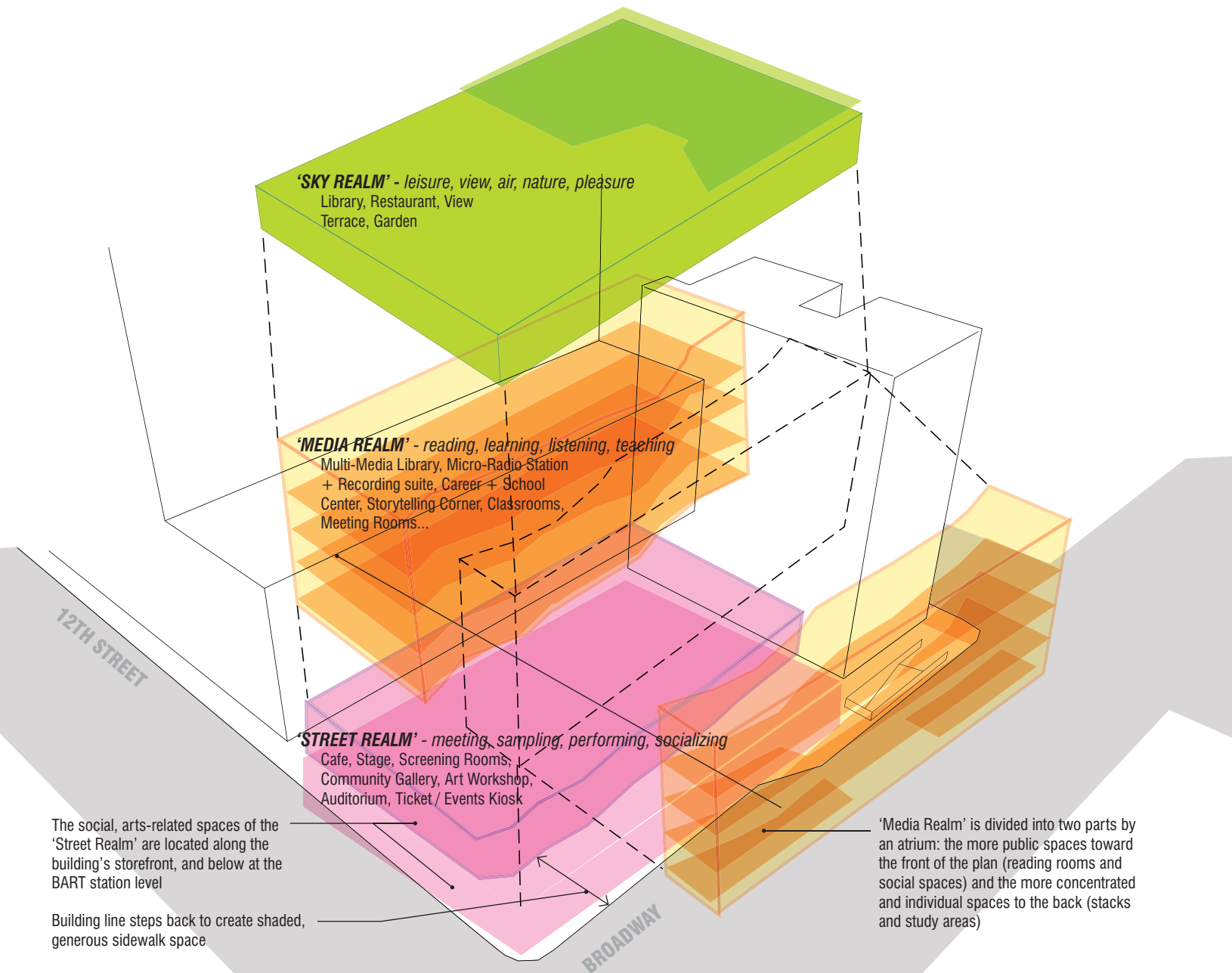

3.16 '3 URBAN REALMS' - Exploded Concept Perspective

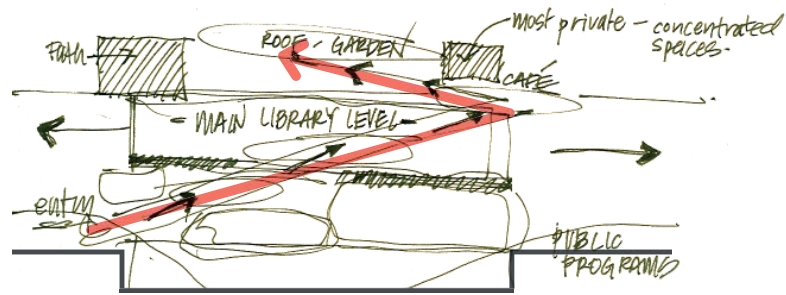

3.17 Early Concept Sketch

DESIGN STRATEGIES:

Social Places and Architectural Elements

This thesis envisions the Oakland Media Library as a multi-layered urban object containing leisure, performance and presentation venues, centered around a public multi-media library. This combination reflects the long-standing idea of the Library as a provider of 'information, education, and recreation', yet expands the range of activities beyond those supported by a traditional library.⁴ By combining a wide range of programs and social venues, the proposal expands the usefulness of the Library, making it more meaningful to a diverse population. To bring this vision to life requires a close focus on the social uses and meanings (both existing and potential) of the urban public library. Also important are the connections between the Library and the physical and social networks of movement, media, arts, and education. The proposed program and architecture form a variety of spatial and experiential qualities, and foster a diversity of use and social situations within the Library. This expanded range of offerings invites more people, for more reasons, into the Library.

The actions of social practice are expressible but not explicable through discourse: they are, precisely, acted – and not read. A monumental work, like a musical one, does not have a 'signified' (or signifieds); rather, it has a horizon of meanings: a specific or indefinite multiplicity of meanings, a shifting hierarchy in which one now, now another meaning comes momentarily to the fore, by means of – and for the sake of – a particular action.⁵

Henri Lefebvre, *The Production of Space*

The design is focused upon creating multiple and flexible venues for social actions which inspire a wide 'horizon of meanings' for the Library. To generate this multiple nature, the Media Library is defined as a set of three 'urban public realms'. These are the 'sky realm' of the roof garden, the 'street realm' of the urban storefront, and the 'media realm' of the Library. These public places are structured and unified by an atrium which penetrates and connects throughout.

The three urban public realms, and the atrium which connects them are defined by three main architectural elements: structure, circulation and building skin. Through the combination of these elements, a gradient is articulated between the most 'social' and most 'individual' spaces within the building. The most public, informal, and loud gathering spaces are located nearer to ground level and the street, while the more individual, concentrated, formal, and intimate spaces are in the rear of the building and the upper levels. The elements of the façade and the structure change scale to represent this gradient. And as skin and structure form the boundaries for most of the building's spaces, the experiential qualities in these spaces are affected by these changes in scale.

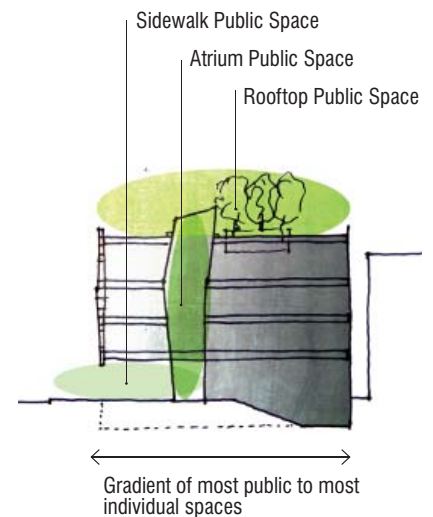

3.18 Layered Public Spaces

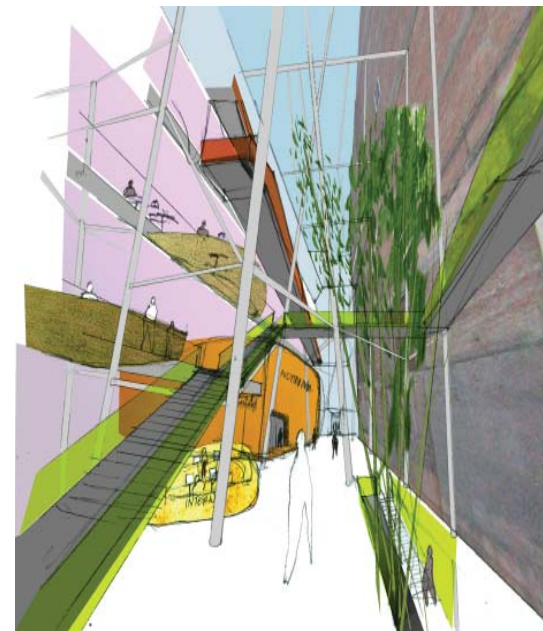

3.19 Early Atrium rendering

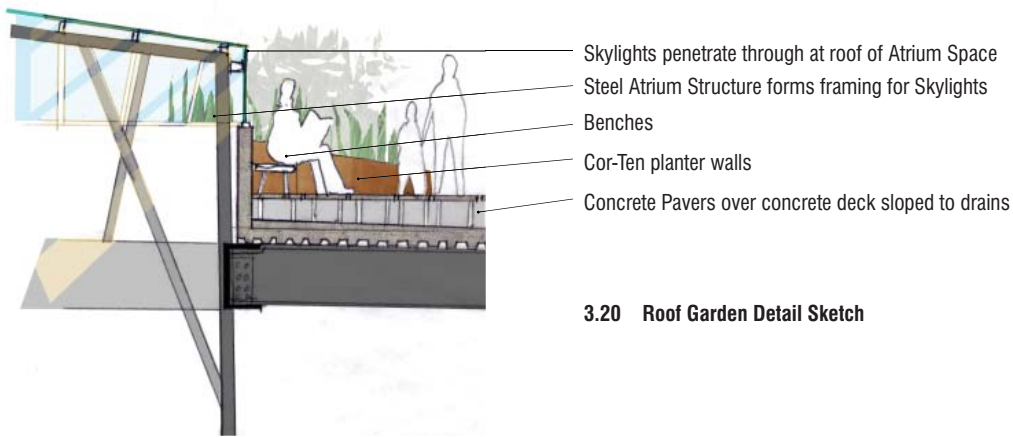

3.20 Roof Garden Detail Sketch

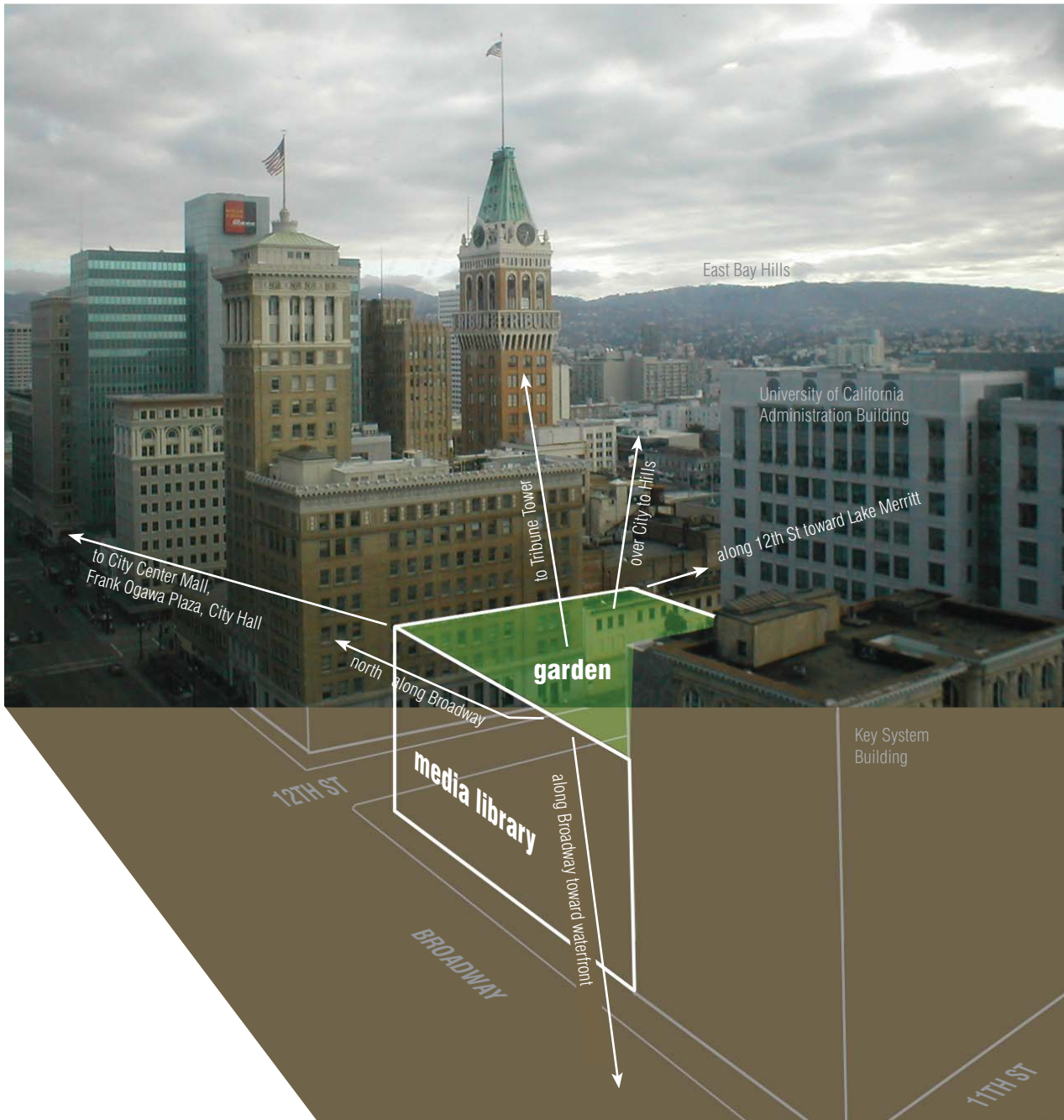

3.21 Views from Roof Garden

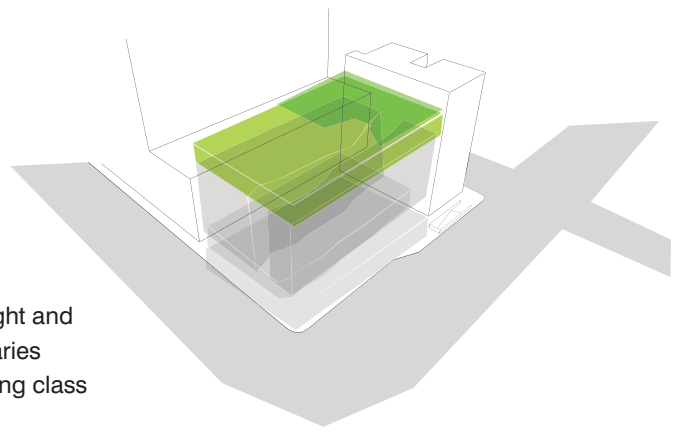

SKY REALM : Urban Roof Garden

In the United States, public libraries have a history of connecting 'light and air' with moral and intellectual goods. In New York, some early libraries incorporated roof spaces which were used as play spaces by working class children.⁶

By bringing together books and fresh air, the open-air reading room combined what Progressive reformers considered the two most potent antidotes to slum life – culture and nature. For many of them, it must have seemed to hold particular promise for improving the lives of the urban poor.⁷

Abigail Van Slyck, *Free to All: Carnegie Libraries and the Transformation of American Culture, 1886-1917*

The vision of the 'sky realm' is likely influenced by the legacy of this concept of beauty and culture as a way to social improvement. However, the proposal focuses on a different kind of idea which is less about 'progressive' reform than about intensifying the kinds of use and pleasure which can be found in cities. From an elevated plane, the city may be seen in a new way, different from the negative portrayals of media or statistics, and different from the gritty, immediate, day-to-day view of the city which comes from using its streets. From a roof space, one can view the city in a more elevated, dreamy, idealized, and abstract way. One can imagine oneself as 'king of the castle', and identify a positive state of being with the urban landscape stretched out and encompassed within one's field of vision. Another purpose of the roof garden is to create a place to enjoy the pleasures of being outdoors, in a garden, where one can eat, read, and relax in the midst of an urban center. The garden is publicly accessible from the street and BART station, as well as from the Library, via a visible public elevator.

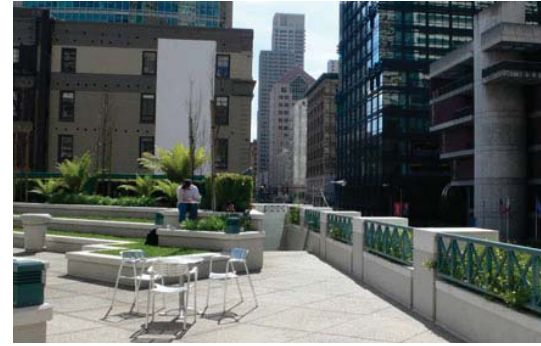

3.22a Roof Terrace in downtown San Francisco

3.22b Roof Garden View



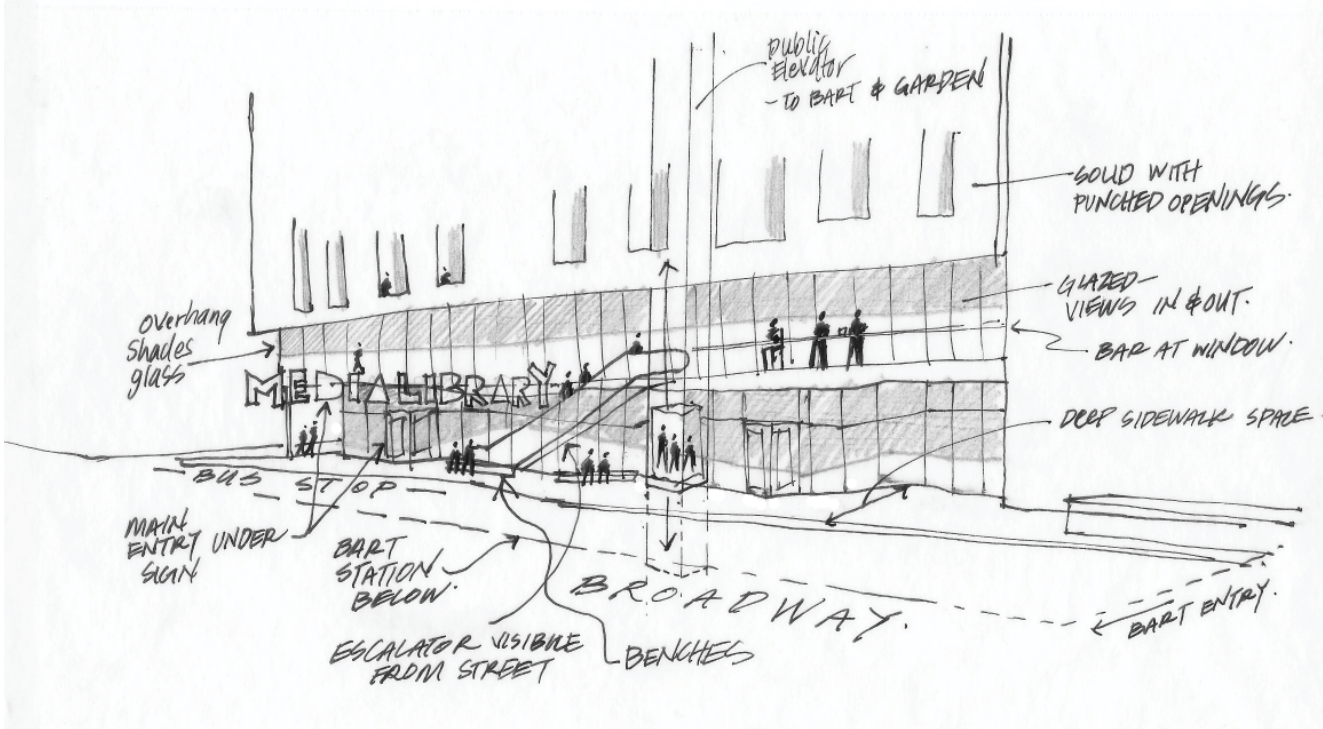

3.23 Street Realm Diagram



3.24a Sidewalk Space

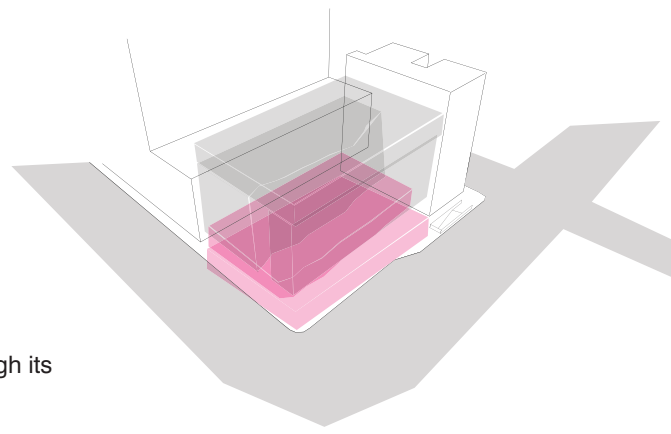

STREET REALM : Socializing, Performance, Display

Often in the past, one strategy in library design has been to make a building that is ‘public’ through it’s ability to impress, popular through its monumentality.

Flagship libraries needed to be not just centrally located and imposing in character, but preferably built in isolation. ... Because [the Library] was a communal utility it needed to be aesthetically attractive to all. It was hoped that a public library which impressed, and hence attracted wide social use, would bridge the gulf between classes. Monumentality and artistry were seen as lasting investments in civic responsibility, the dividend to be paid in the currency of social stability.⁸

Alistair Black, *A New History of the English Public Library*

Thus library entry points are often very symbolically potent. The grand staircase of the New York Public Library is one example of this, and the glass-roofed mall of the Vancouver Public Library is another. This proposal, while recognizing the need to make the library visible and attractive to the public, questions the need for monumentality and isolation. It draws instead on the concept of the Library located on the main street, playfully connected to the street. This concept is developed in the Idea Store projects by David Adjaye for the London borough of Tower Hamlets. The Chrisp Idea Store sensitively supports its context, supporting the Chrisp Street Market by placing itself above a row of small shops, and touching down only at its entryway on a public square. The Whitechapel Road Idea Store overhangs the sidewalk, sheltering an escalator which draws people up from the street to each of the library’s many access points.

The ‘street realm’ is imagined as an urban storefront for the Media Library, a space of attraction which engages and draws in the activity, energy, and day-to-day social life of the city. Programmatically, the ‘street realm’ brings together activities which both attract and depend on pedestrian traffic: a café, stage, DJ booth, screening rooms, gallery and arts workshops, an info/ticket outlet, and an auditorium. These popular, active and engaging programs, visible both from the street and the BART station below, invite a wide range of uses and social activities into the library. This creates places within the Media Library for the day-to-day social and artistic activities of individuals and urban communities.



3.24b Vancouver Public Library Entry Mall (Library to right, retail and office building to the left) designed by Moshe Safdie and Associates (1995)

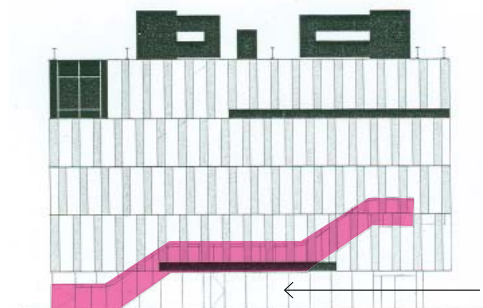

Entry Space - overhang

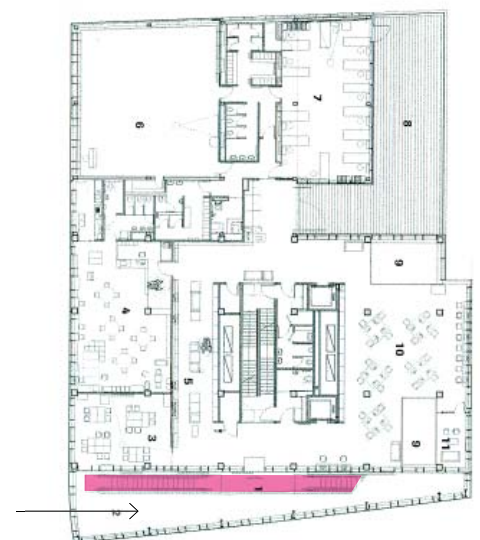

3.24c Idea Store, Whitechapel, London designed by Adjaye Associates (2005)



3.25 View into Gallery and Art Workshop





3.26 Main Entry Lobby - Cafe, Screening Lounge + Stage, View Up into Atrium



3.27 Atrium Entry - View up Escalator & Stair from Entry

MEDIA REALM : Public Multi-Media Library

The Media Library, positioned between the street and the garden, is the central element of the proposal. Its central and most impressive space is the atrium. Atria or halls, often with light entering from above, have frequently been used in library designs to create an awe-inspiring sense of grandeur.⁹

The atrium is a compressed space, tall in comparison to its width. The shifting form and branching structure of the atrium create a space of many varying conditions; some faces overhang the visitor, while others lean outward and open up to the light above. The glazed northern face of the atrium and skylights admit light into the core of the building. The eastern side of the atrium (adjacent to the library stacks) is partially screened by metal mesh, over which flowering plants climb, enclosing the more intimate study areas and alluding to the presence of the garden above. Stairs and bridges span the atrium's void. Areas of dappled light and dark, and asymmetrical surfaces of varied texture, create a complex and variegated experience within the space. The resulting space has an intimate, human-scaled monumentality which is derived from intriguing contrasts and complexity rather than from exaggerated scale and solidity.

Acoustic, gestural and ritual movements, elements grouped into vast ceremonial unities, breaches opening onto limitless perspectives, chains of meanings – all are organized into a monumental whole. ... Monumental space permits a continual back-and-forth between the private speech of ordinary conversations and the public speech of discourses, lectures, sermons, rallying-cries, and all theatrical forms of utterance.¹⁰

Henri Lefebvre, *The Production of Space*

The atrium divides the plan of the library into two parts. Along Broadway are the more communal reading and lounge spaces, and across the atrium are the stacks and individual quiet reading spaces. Special programs such as the storytelling corner, a school/job resource center, and the micro-radio station and recording suite flank the double-height main reading hall on the Broadway facade.

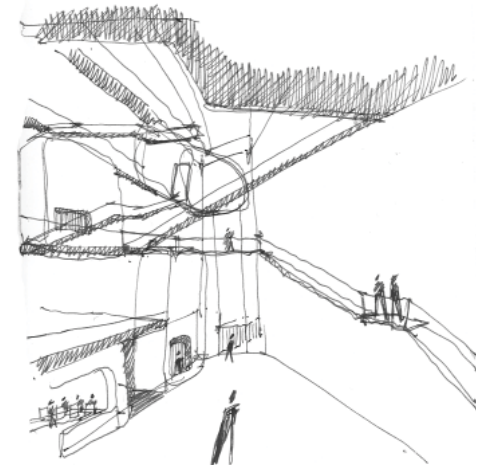
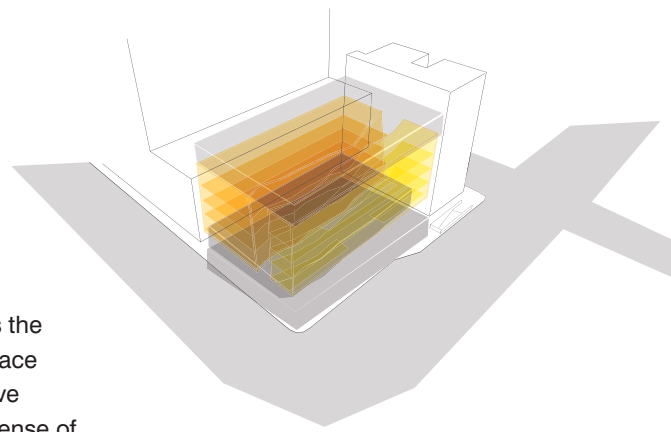

3.28 Early Atrium Sketch

3.29 Second Floor Lounge, adjacent News / Popular section with bar, table, and views out onto street





Atrium Between New Building and Existing (Initially Considered) :

- becomes the edge between the existing building and new
- fails to engage a significant portion of new building
- not central enough to serve the Media Center as a circulation space
- doesn't address Broadway very clearly

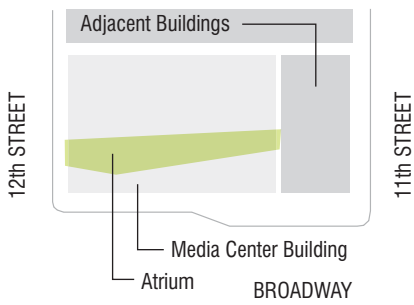

Atrium Parallel to Broadway (Chosen Option)

- divides the library into two asymmetrical parts: creating spatial difference to which the program layout will respond
- engages the sidewalk along the length of the site on Broadway
- Atrium has more central location suited to its circulation function

3.30 Atrium Configuration Options



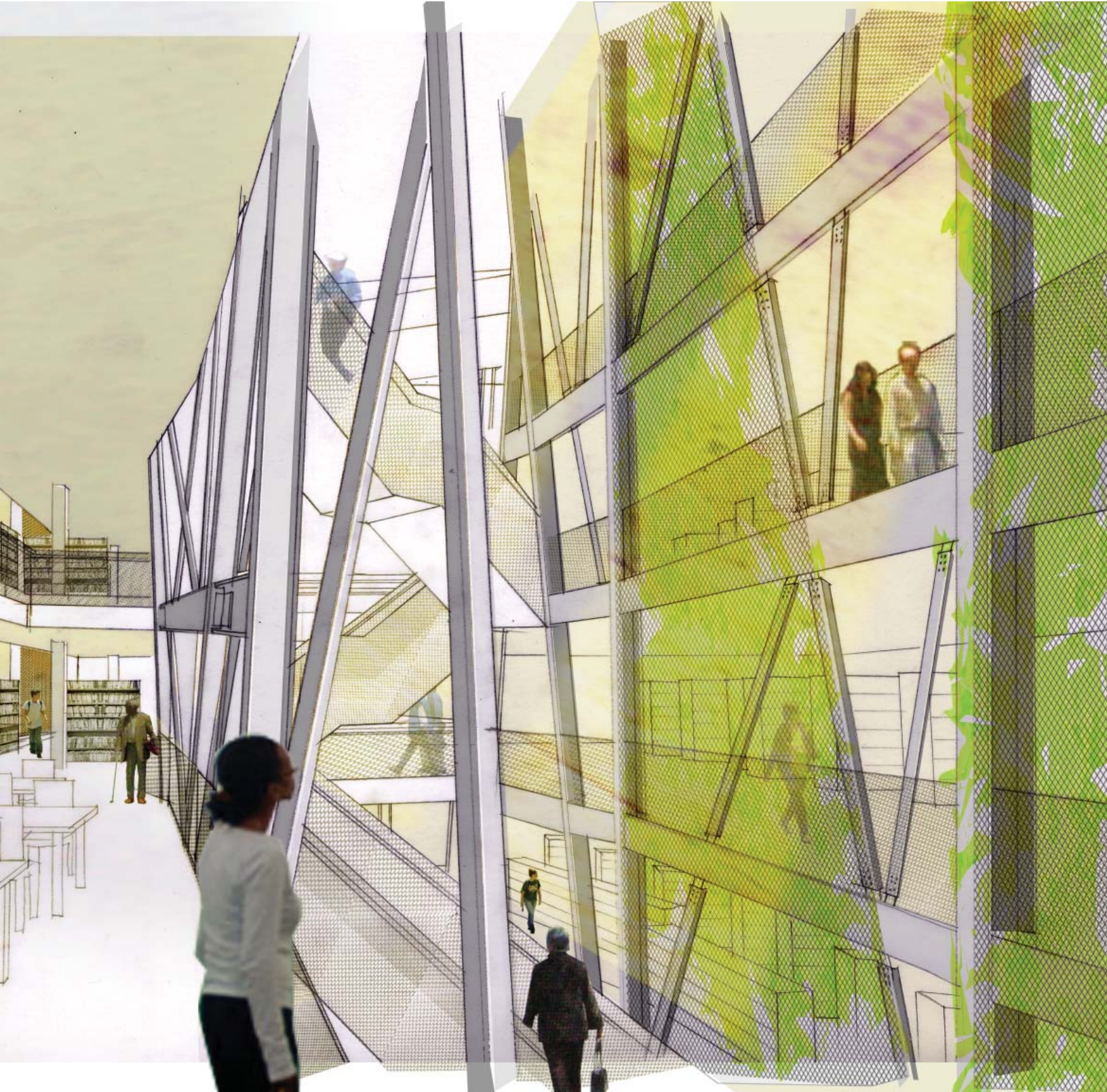

3.31 Main Reading Hall View

3.32 Precedents

Tod's Omotesando, Tokyo, 1997 - Toyo Ito
Sendai Mediatheque, Sendai, 2000 - Toyo Ito (2)
BCE Galleria, 1990 - Calatrava
Sculpture for a Large Wall, 1957 - Ellsworth Kelly

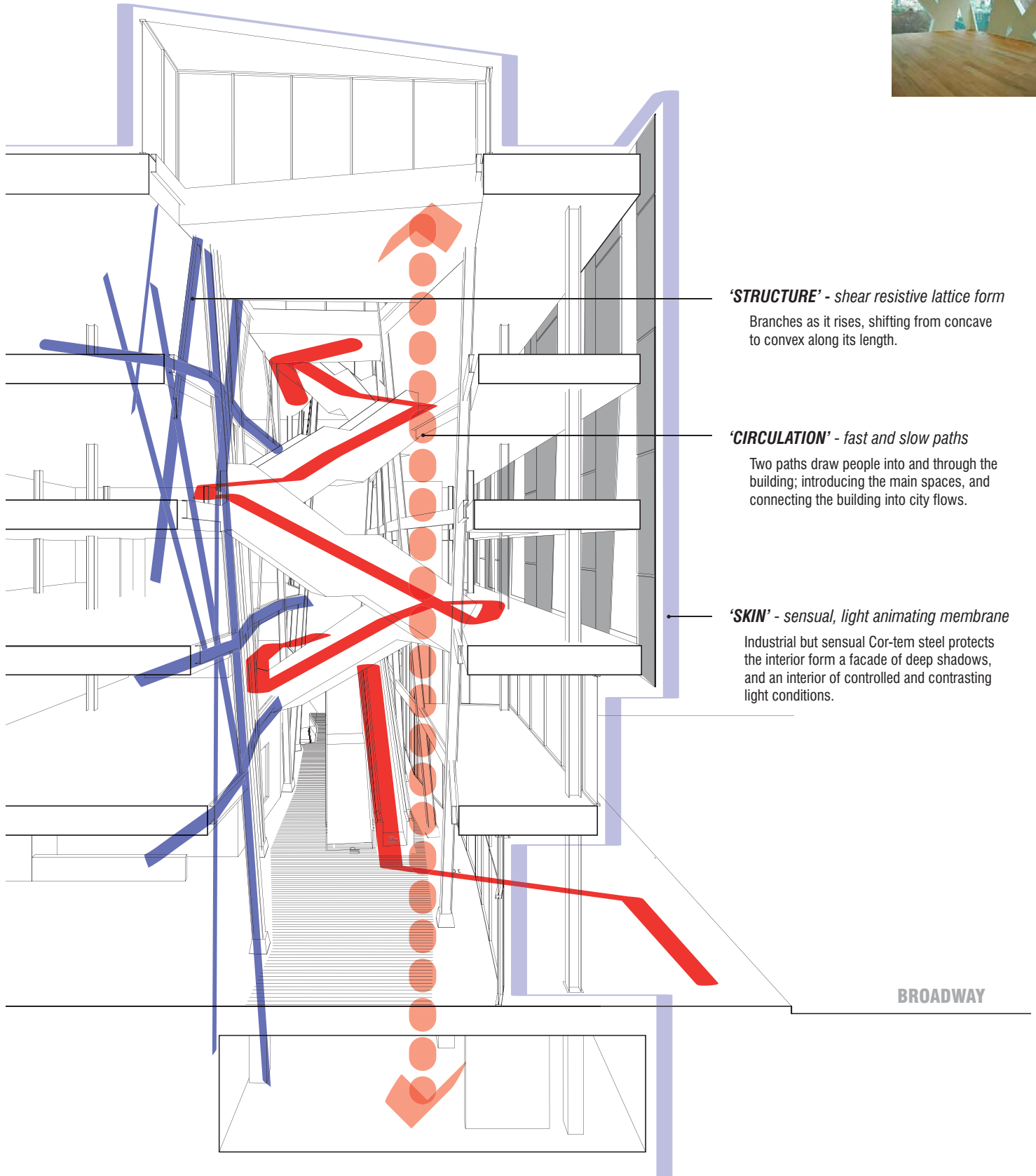
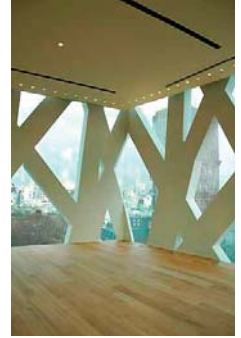

3.33 Main Architectural Elements : Structure, Circulation, Skin



STRUCTURE

The design for the atrium structure responds to the necessity for shear resistance in a seismically volatile place. Through its dynamic form, the structure makes visible the force and violence of the landscape. It represents the ground's suppressed potential for rupture and transformation. This concept is inspired in part by the active, narrative view of structural design espoused by Cecil Balmond:

Slip and jump have varying notions of time and distance embedded in them. Ratios of distance to time lead to ideas of velocity, pulse, and rates of change. In tectonic terms this sense of motion is either arrested or frozen or just about to be launched. By contrast, reductionist thinking assumes structure to be a static, steady-state, baseline. Not much is asked of it but to serve and be 'honest'. Surprisingly, this guise of honesty often comes out as 'dumb'. Why not structure as an animation that provokes synthesis?¹¹

Cecil Balmond, *Informal*

The main steel columns of the shear structure are evenly spaced at grade and lean in both planes as they rise through space. They are tied together by deep horizontal members, which support the floor edges and act as smoke baffles. Between the main columns and beams are more delicate, laterally branching steel channels, which are increasingly lighter and more densely spaced on the upper levels. These diagonal members tie the structure together into a shear-resistive network. The resulting complex structure has a balance between its inward and outward-leaning components and forms a stable dynamic whole.

One precedent for the structural concept is Toyo Ito's Mediatheque in Sendai, Japan, which has giant 'tube' columns welded together out of many tube-steel members. Also inspirational were various buildings which employ non-rectilinear or 'diagrid' structural skins to efficiently merge the structural necessities of vertical loads with resistance to lateral wind and seismic forces, while avoiding the use of massive shear walls. The steel structure is also informed by conceptual models of the organization of knowledge as a branching tree or information meshwork.

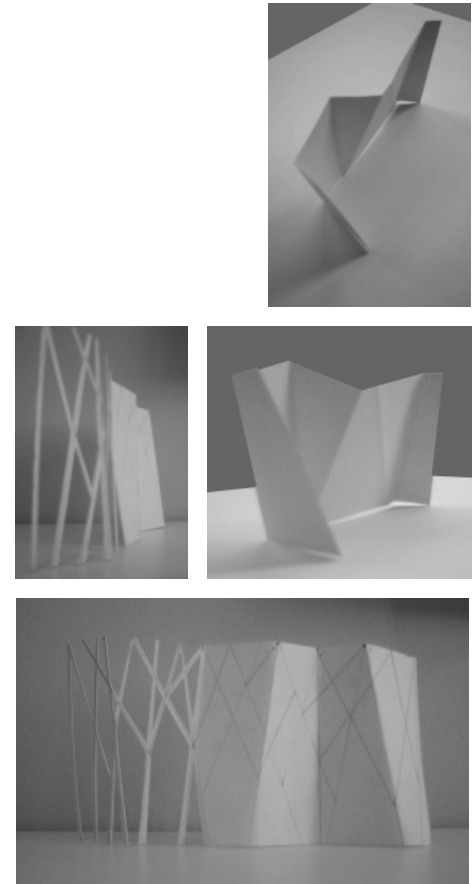

3.34 Sketch Models

3.35 Atrium Shape Diagram

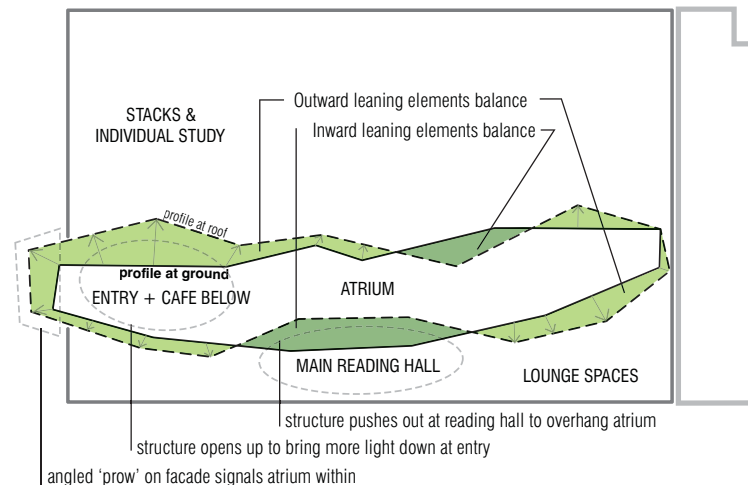

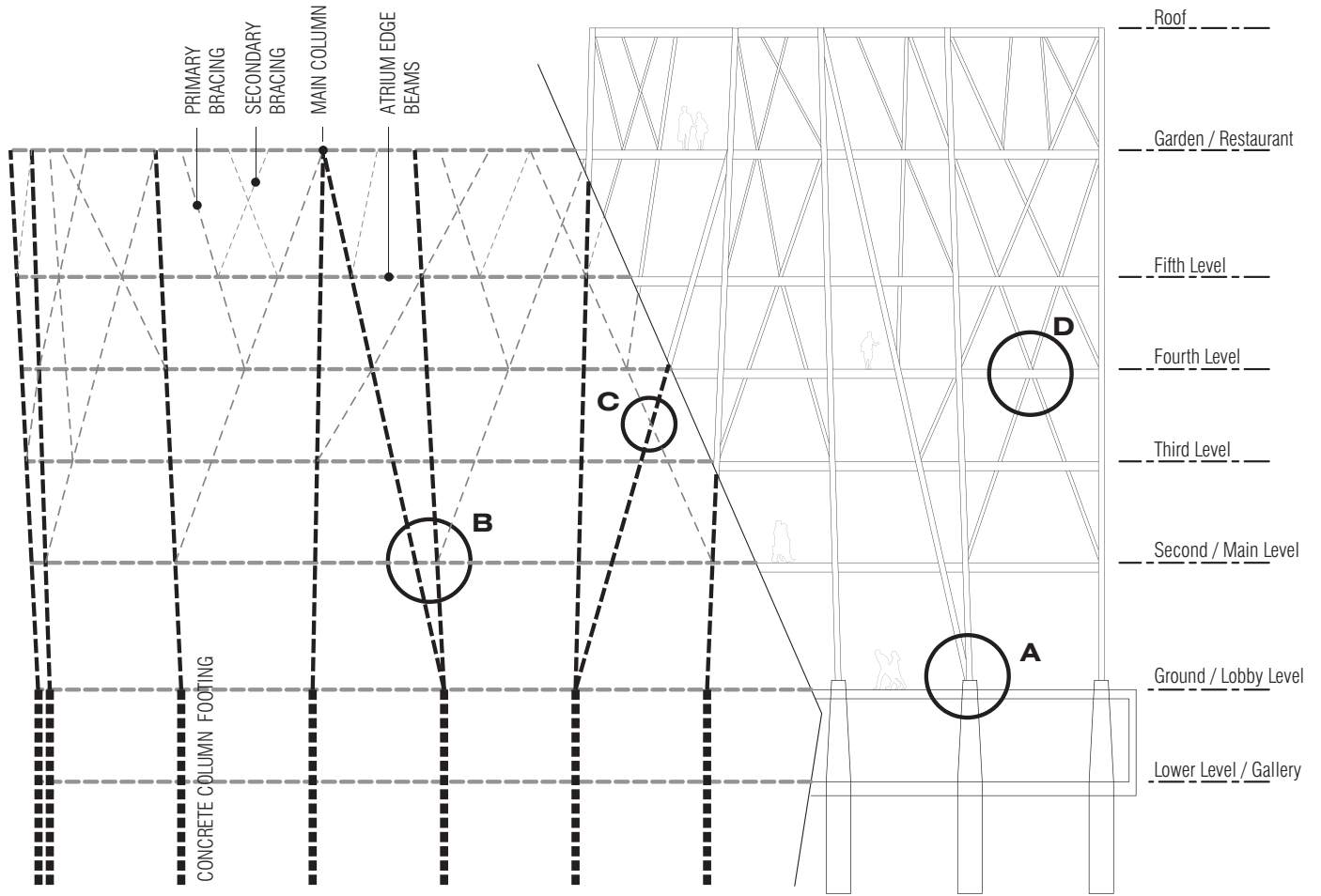

ATRIUM STRUCTURE - ELEVATION DIAGRAM

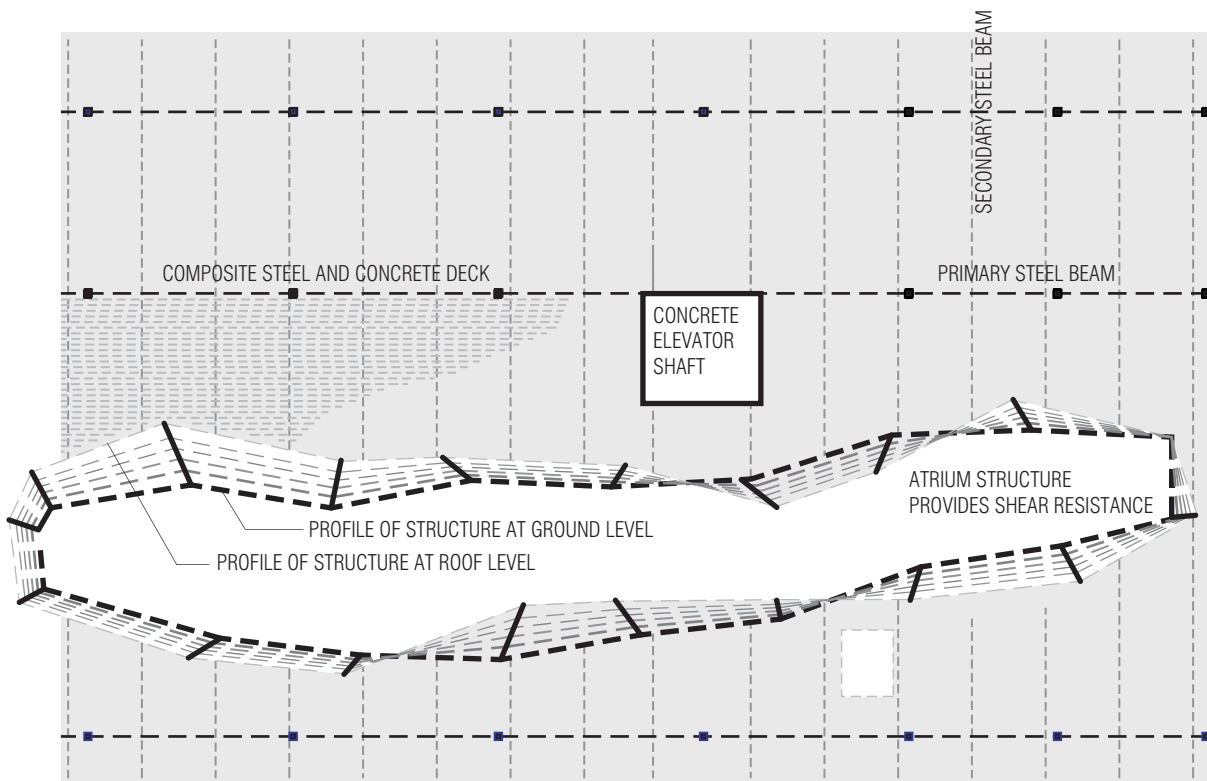

STRUCTURAL FRAMING PLAN

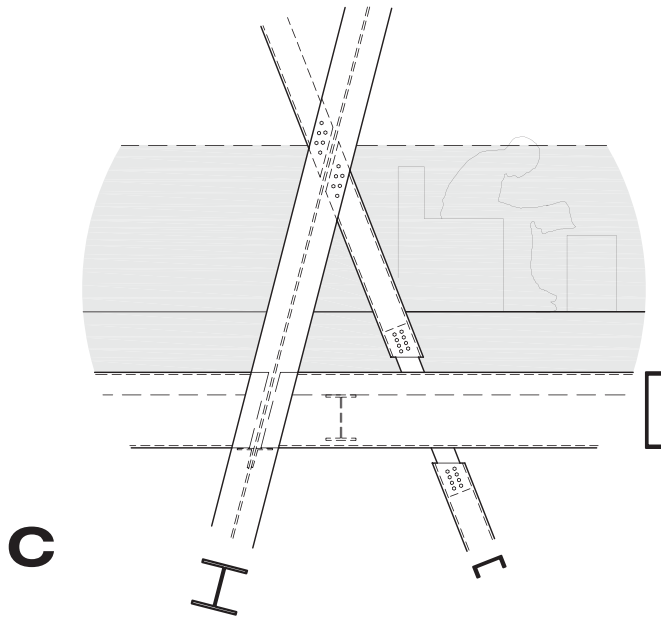

C

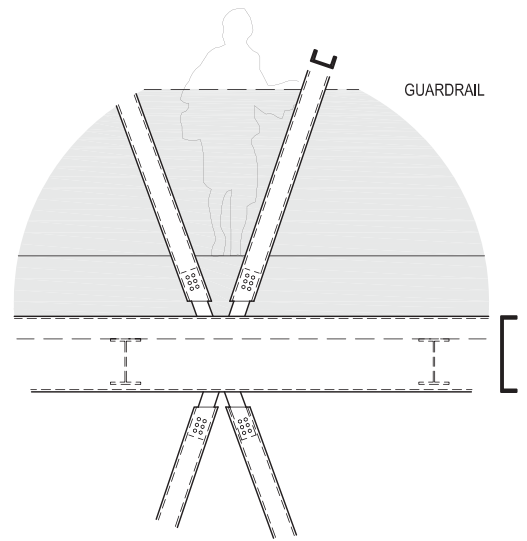

D

Design Development

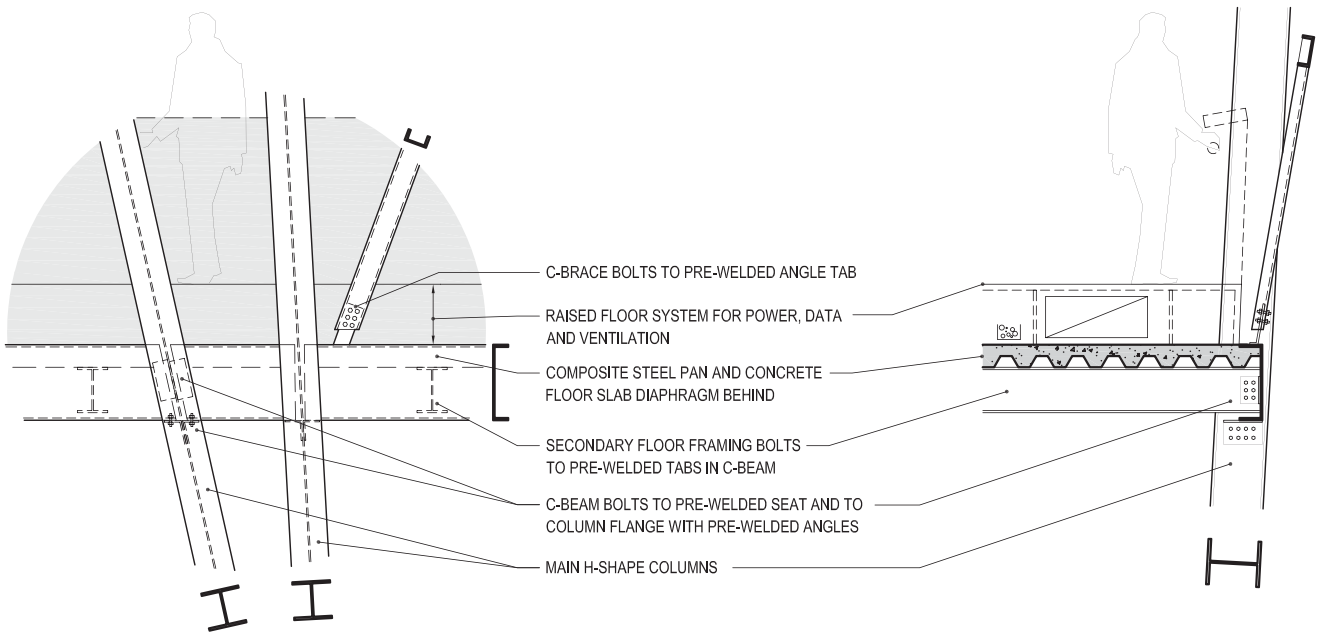

B

- C-BRACE BOLTS TO PRE-WELDED ANGLE TAB
- RAISED FLOOR SYSTEM FOR POWER, DATA AND VENTILATION
- COMPOSITE STEEL PAN AND CONCRETE FLOOR SLAB DIAPHRAGM BEHIND
- SECONDARY FLOOR FRAMING BOLTS TO PRE-WELDED TABS IN C-BEAM
- C-BEAM BOLTS TO PRE-WELDED SEAT AND TO COLUMN FLANGE WITH PRE-WELDED ANGLES
- MAIN H-SHAPE COLUMNS

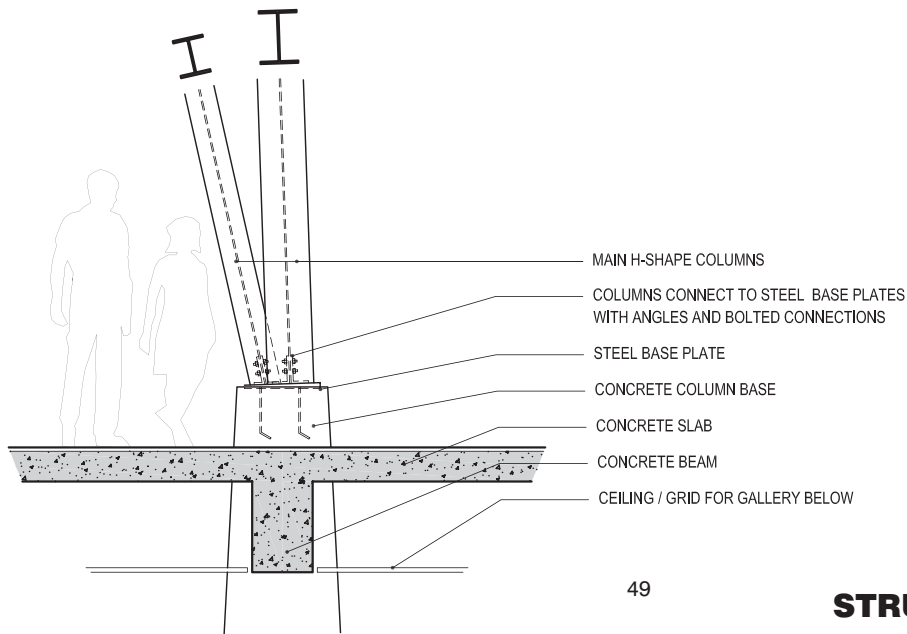

A

- MAIN H-SHAPE COLUMNS
- COLUMNS CONNECT TO STEEL BASE PLATES WITH ANGLES AND BOLTED CONNECTIONS
- STEEL BASE PLATE
- CONCRETE COLUMN BASE
- CONCRETE SLAB
- CONCRETE BEAM
- CEILING / GRID FOR GALLERY BELOW



CIRCULATION PATH - PARALLELOGRAM LOOPS.

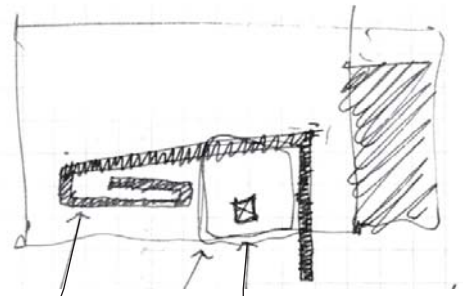

3.37 Circulation Concept Sketches

ELEVATOR : high speed, connecting all public spaces: underground, street, garden

STAIR : slow, spiralling, bridging, gradually revealing the building to the traveller

PUBLIC ELEVATOR

Glass elevator creates fast, visually revealing path through building and connects all public spaces

ATRIUM STAIR

Looping stair connects main library spaces. Narrow and wide bridges create secondary links and provide places to sit and experience the atrium space

LIBRARY ELEVATOR

Library elevator serves all library levels, as well as library and gallery service areas

Public Roof Terrace and Garden

Library Circulation Desk: control point for library materials

Upper Reading Lounge

Main Reading Hall

Upper Lobby

Administration

Lower Lobby

Library Circulation Desk: control point for library materials

LOADING ZONE: service area and book drop

STREET: Bus stop, car and schoolbus drop-off area, waiting area, pedestrian connections, bike parking

BROADWAY

Gallery Level

BART station entry

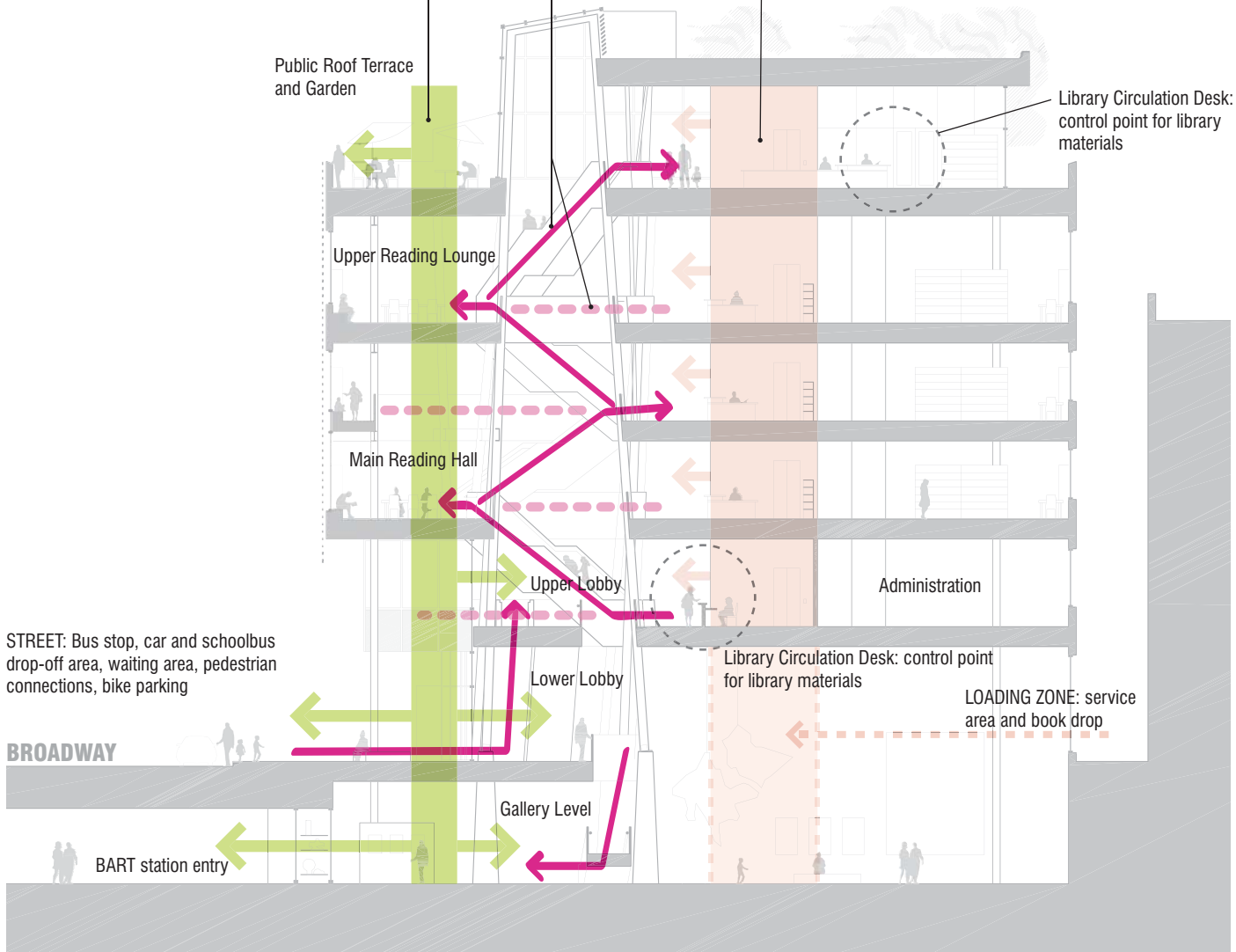

3.38 Circulation Elements

CIRCULATION

The building has two main circulation routes. The first is the glazed public elevator which connects all non-library spaces: from below street level, to the 'sky realm' above. Travelling in this elevator is fast and efficient, but also visually revealing, as it offers glimpses into the library's spaces. The second route is a slower, more active excursion up stairs which criss-cross the atrium in a looping path toward the roof. This path begins with an escalator which is clearly visible through the glazing to attract people from street level up to the library lobby. From the second level, stairs ascend through the atrium, linking the most important spaces of the library: the reading hall on the third level, stacks on the fourth, the lounge on the fifth, and finally the roof garden above.

The stair crosses the atrium at varying angles. Instead of giving a single sense of direction, this route allows multiple, surprising, and unpredictable views, both up and down the atrium as well as across to adjacent program spaces. A person's experience of the space is different depending on his or her place within it. Thus movement through the library is an exploration, in a way like the process of browsing through the media it houses. The concept of framing multiple perspectives or experiences also informs the architectural details. Perforated metal guardrails, employed throughout, appear immaterial or transparent from a distance, yet feel solid and sturdy to a person leaning up against them. In a similar way, the visitor's experience of the atrium and its structure is multiple. From the street the columns appear vertical and uniform; from within they appear to enclose a void; from the stacks the structure appears as a column line; and on the roof the structure penetrates to form skylights, which become lanterns in the evenings.

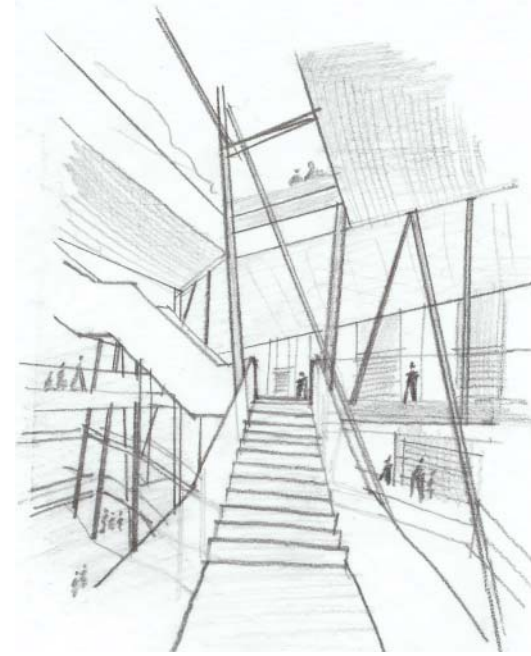

3.39 Crossing the Atrium - Sketch

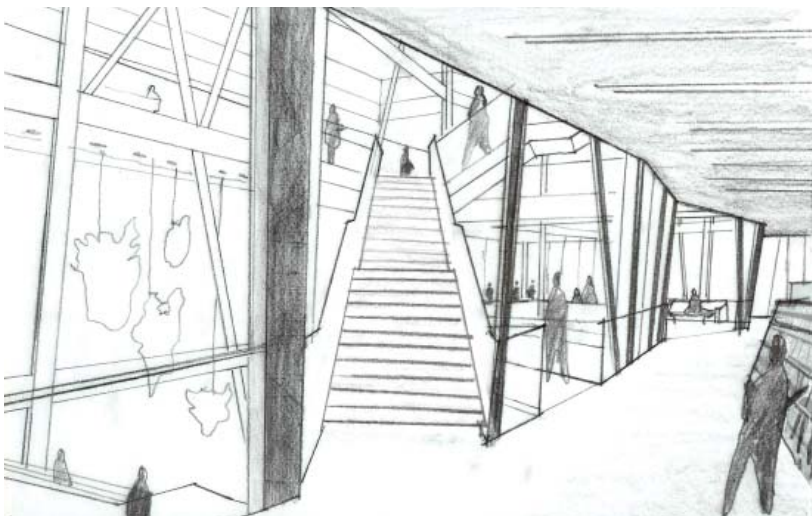

3.40 Second to Third Level - Sketch

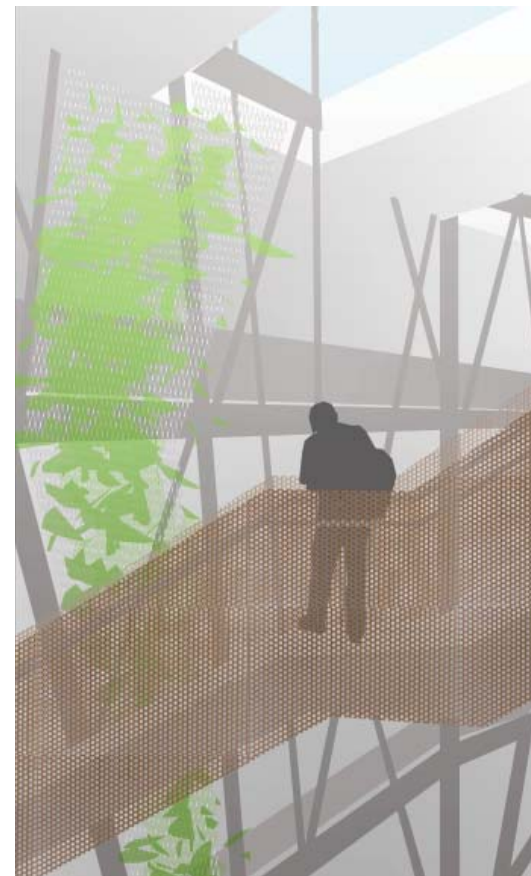

3.41 Stair Detail



3.42 Reading Bridge



3.43 Atrium - view to the North

Elevation as interplay of solid + void -
 similar to int-elev, but with different
 scale + materials + functions.

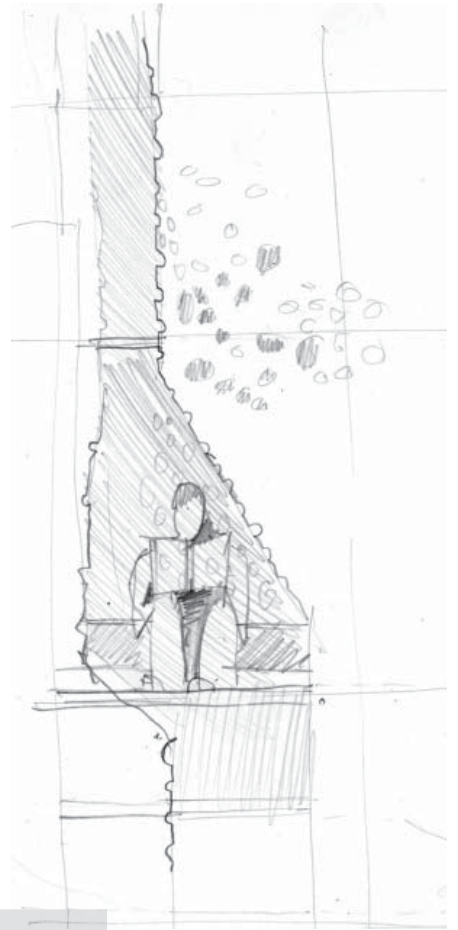
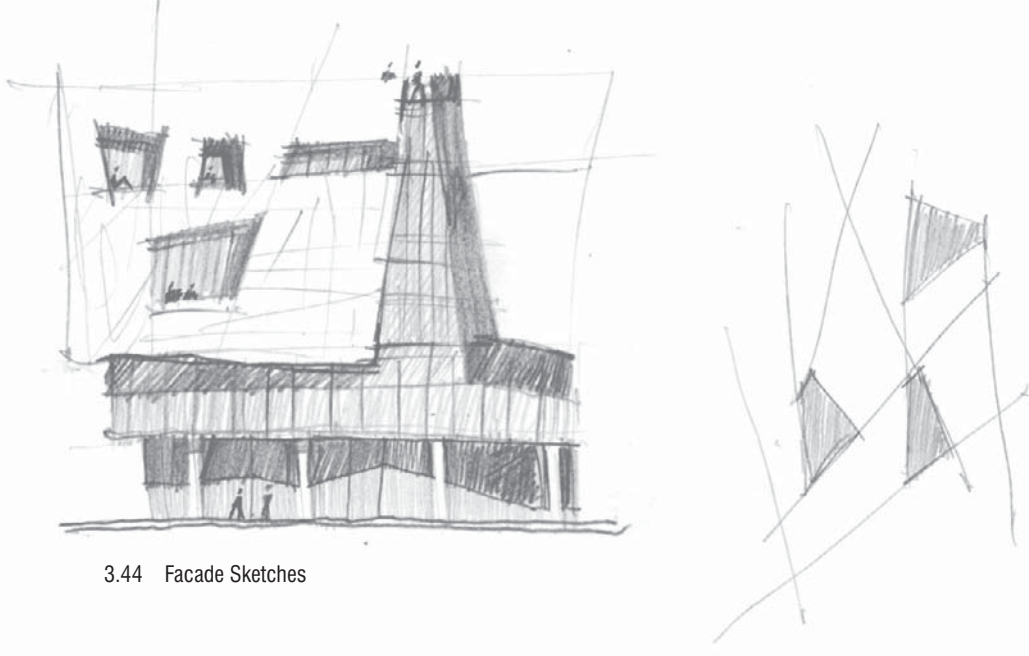

3.44 Facade Sketches

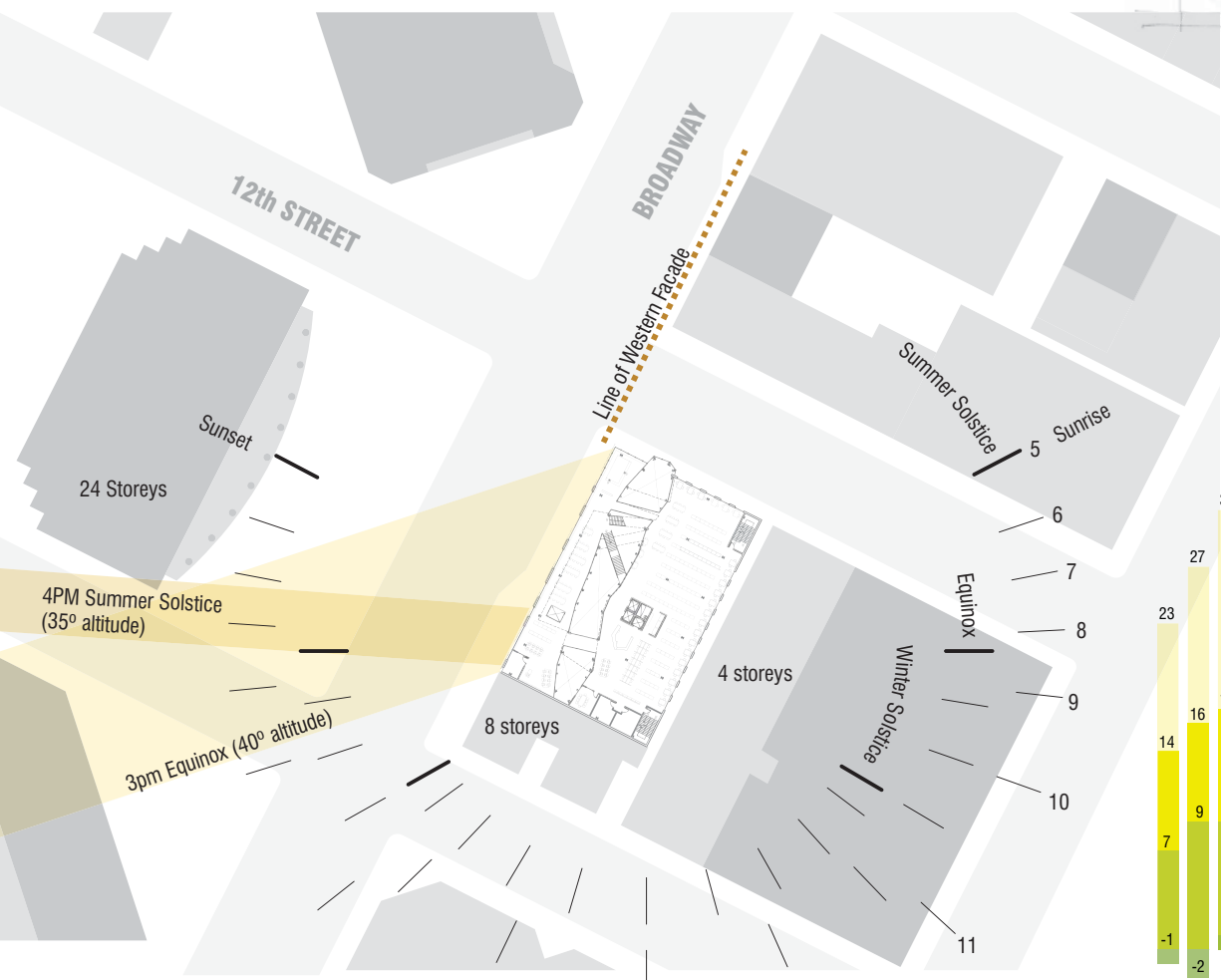

3.45 Solar Diagram

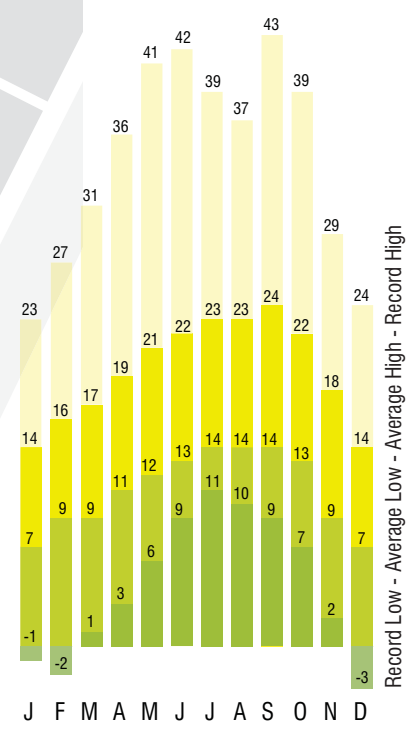

3.46 Oakland Average Temperatures (in degrees Celsius)



Metal Panels
3.47 Textural Context



Lightwell, Cornice



Contrast



Relief

SKIN

Oakland is full of contrasting textures. The 1920s and 30s laid the groundwork for the downtown with the construction of solid, ornamented, brick and terra-cotta clad buildings, many of which survive today. The next most prominent textures are the slick, reflective curtain walls and polished granite of towers built between the 1970s and today. In this context, Cor-ten steel is chosen as the main cladding for the Media Library. It is solid enough to bring a sense of permanence to the institution, yet at the same time it has an organic, earthy texture and intense colour, which differentiate it from the smooth panel systems which clad the neighbouring banks and office buildings. Cor-ten changes over time, weathering gracefully. Although it projects a sense of solidity, it can be formed into relatively light cladding to lessen structural loads, and decrease the danger of falling panels during future earthquakes.

The main façade is extensively solid, with deep-set windows which are largely shadowed by perforated Cor-ten screens. This responds to the context, and to the necessity to minimize glare and solar gain which could make laptop use difficult and create high loads on the cooling system. The perforated copper skin of the DeYoung Museum, located in San Francisco's Golden Gate Park, was one inspiration for this cladding.¹² Used to shade the library's windows, the perforated screens cast intriguing shadow patterns which animate the reading rooms within, while at night they appear translucent and reveal silhouettes within.

Below the Cor-ten clad section of the façade, the building line is set back. The result is a shaded, glazed level which encloses the second storey lounge, where people can display themselves at the window, and watch the street life go by. At street level, the building line is set back further to reveal the shifting edge of the atrium. This excavation creates a shaded and sheltered sidewalk space which invites passers-by to enter and use the urban space created by the building, even if not the interior of the building itself.

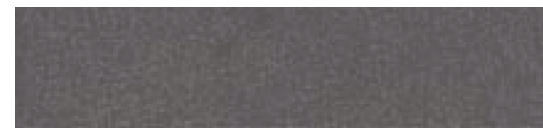
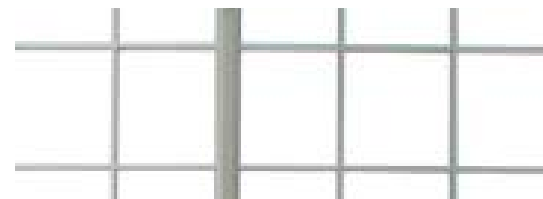
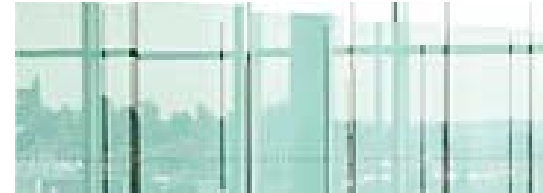
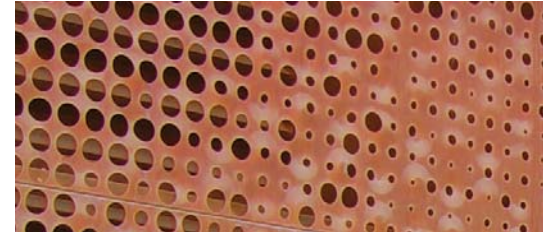

3.48 Material Palette

Perforated and Solid Cor-ten panels, clear glazing, solera insulated glazing panels, Books, Wood, Perforated metal, Recycled rubber floor tiles, Ceramic Tiles

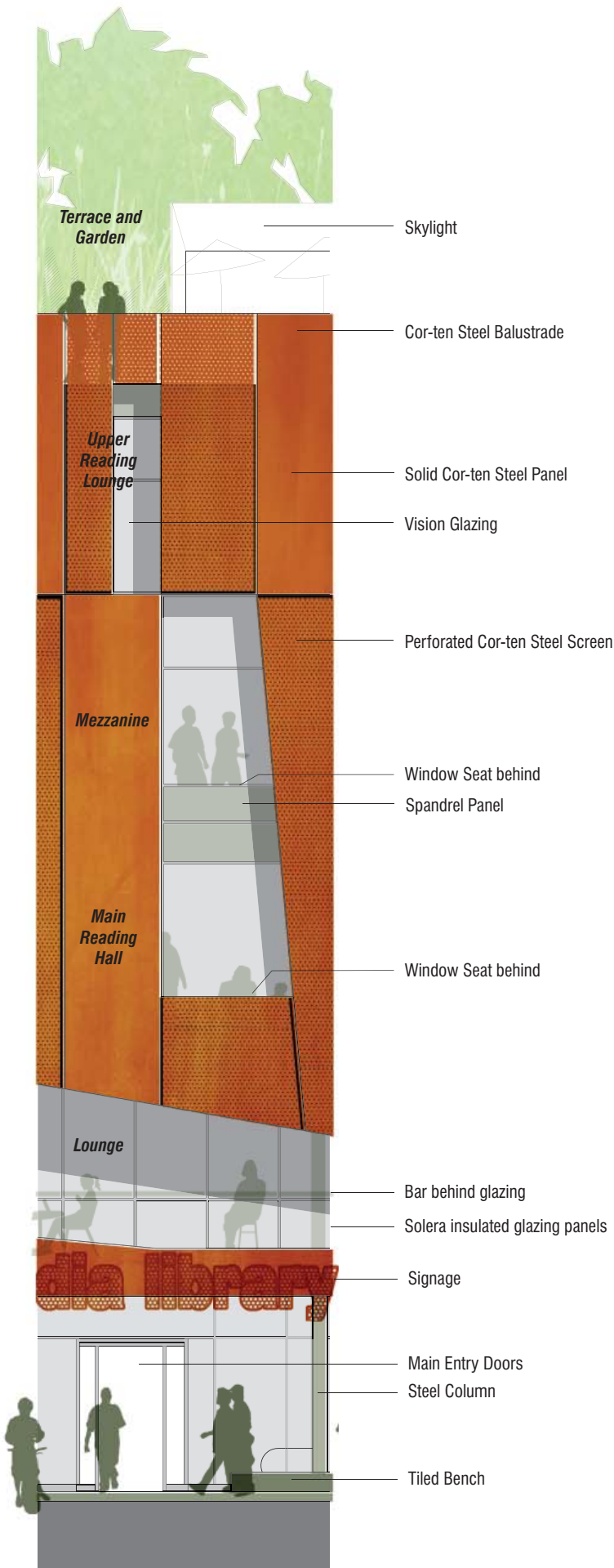

3.49 Facade Detail



3.50 Exterior View



Parent / Caregiver and Kids:

Oakland kids and their caregivers come to story hour at the story space on the third floor, art classes at the ground-floor workshops, and daytime kids' movies at the ground floor screening room. Kids can also play in the roof garden while their parents chat.



Recent Immigrant:

New Oakland residents use the library to get their bearings. They visit to learn about local clubs and events at the ticket / info booth, and check email, job postings, and schools online. Some seek language-learning materials, while others read newspapers and novels from their home place. Some participate in clubs, night classes, and language tutoring. Children can find books, music and movies in many

High School / College Students:

Students use the library for group and individual study, gathering around big tables in the main reading hall, curling up on window seats to daydream, browsing music and DVD collections. They also come here to hang out and gossip in the cafe, hidden corners, and the rooftop garden.

Homeless Person:

Homeless people visit the library to read the newspaper and check email. They also use it as a place to warm up, relax in a comfortable chair, or sit in the sun on the roof.

Artist / Community Group Participant:

Local artists and members of clubs and volunteer groups use the library as a venue and resource for their activities. Artists show their work in the community gallery, volunteers arrange art classes and skill-shares. Film and poetry clubs use the cafe and screening rooms for performance and viewing. Volunteers run local broadcasting programs out of the broadcasting suite, which is also a place where volunteers teach DJing. A community gardening group maintains the rooftop garden.



PATRON SKETCHES :

Attracting Oakland's diverse public

To improve the Library's relevance and appeal for Oakland's diverse public, the proposed Media Library brings together a wide range of activities to form 'public realms' of varying qualities. These sketches imagine the ways that different users find their niche in the Media Library.

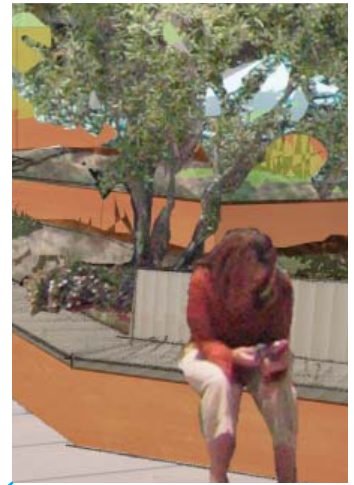

Downtown Office Worker:

Nearby office workers come during lunch to the main floor cafe, the roof-top restaurant, or the garden. They stop by after work to pick up books for their kids, attend an art opening, or meet a friend, before commuting home by BART. If the roof-top restaurant serves good food, they might bring a date here.

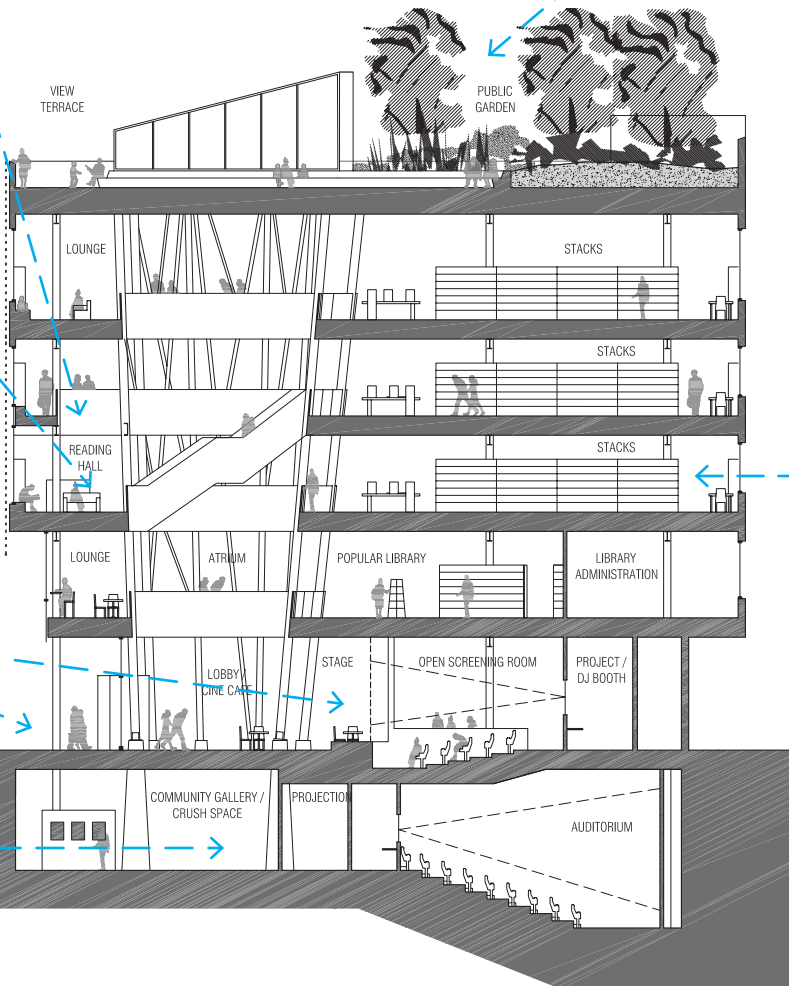

Reader / Information Seeker:

People seeking a place to read, think and work find quiet desks at windows around the outer edges of the stacks. These spaces are sheltered from the public parts of the building, and are surrounded by books.

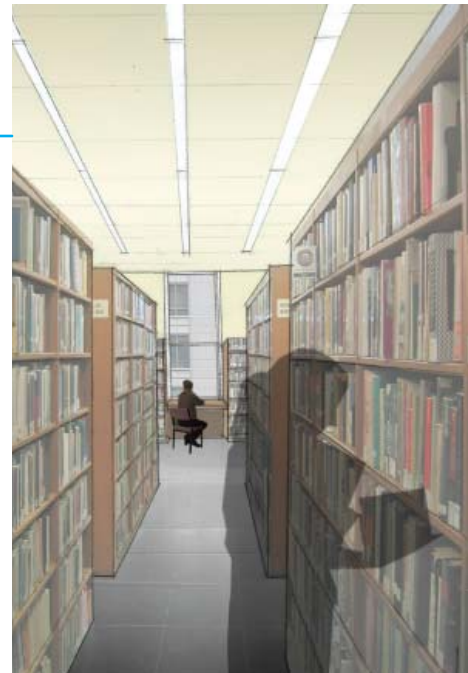

MEDIA LIBRARY PROGRAMME

GARDEN

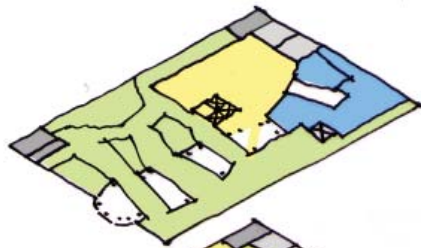

5

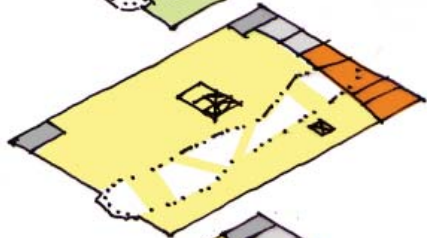

4

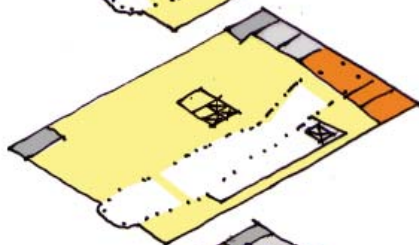

3

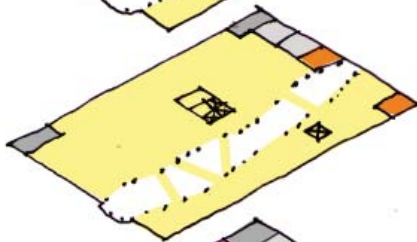

2

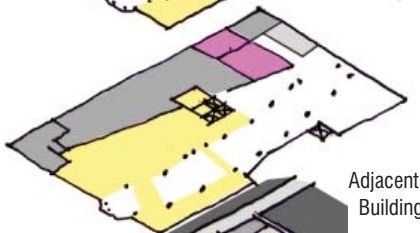

GROUND

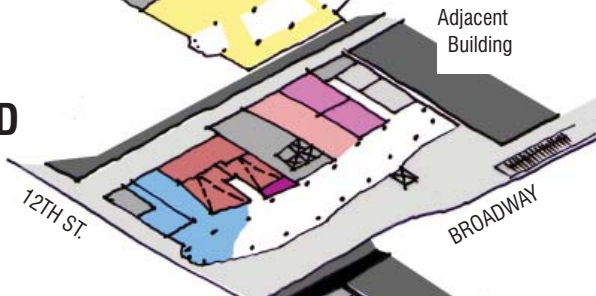

-1

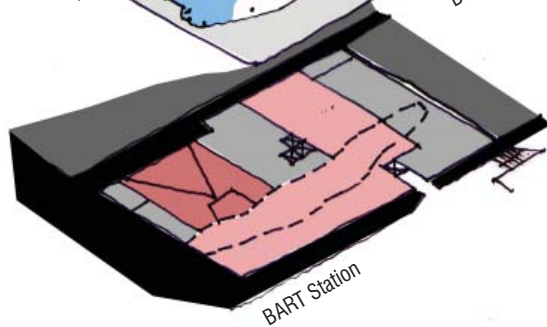

	Public Garden and View Terrace	7,530 sq.ft.
	Upper Mediatheque Level	2,580 sq.ft.
	Restaurant	2,470 sq.ft.
	Washrooms & Services	1,350 sq.ft.

	Stacks and Study Space	7,320 sq.ft.
	Upper Reading Lounge	3,230 sq.ft.
	Meeting Rooms	1,180 sq.ft.
	Washrooms & Services	970 sq.ft.

	Stacks and Study Space	7,320 sq.ft.
	Kids Media Space	650 sq.ft.
	Microradio Record/Broadcast Suite	1,880 sq.ft.
	Washrooms & Services	970 sq.ft.

	Stacks and Study Space	7,320 sq.ft.
	Main Reading Hall	1,510 sq.ft.
	School and Career Center	1,240 sq.ft.
	Kids Story Space	540 sq.ft.
	Meeting Rooms	220 sq.ft.
	Washrooms & Services	970 sq.ft.

	Lobby & Internet Lounge	2,910 sq.ft.
	2 Classrooms	860 sq.ft.
	News / Popular Stacks and Lounge	4,090 sq.ft.
	Library Administration	2,580 sq.ft.
	Washrooms & Services	1,350 sq.ft.

	Exterior Covered Space	2,910 sq.ft.
	Lobby / Lounge Space	3,230 sq.ft.
	Cafe + Seating Area	1,610 sq.ft.
	2 Screening Rooms	1,830 sq.ft.
	Art Space Workshops	1,080 sq.ft.
	Washrooms & Services	1,350 sq.ft.
	Delivery and Loading	1,400 sq.ft.
	Oakland Events and Ticket Outlet	130 sq.ft.

	200 Seat Auditorium	2,420 sq.ft.
	Community Gallery	6,890 sq.ft.
	Service Spaces	5,540 sq.ft.

Total Gross Floor Area 78,950 sq.ft.
Outdoor Space Area 10,440 sq.ft.

Average Useable Floor Plate Area 3,230 sq.ft.
Average Atrium Area (3rd) 12,200 sq.ft.
Average Floor Plate TOTAL 15,430 sq.ft (1,430 sq.m)

CONCLUSION – EFFECTS :

Programmatic, Social, Spatial, and Experiential Diversity

The proposed Oakland Media Library building creates a diversity of places which support many kinds of activities and social situations; from formal and educational, to informal and leisurely. This is accomplished by defining the library as a set of public places, which serve different purposes, and have distinct qualities. The diversity of spaces of varying scales, moods, and programs makes room for a wide range of users to find a place within this institution. This strives to improve the Library's effectiveness as a 'public good'. Beyond making places for many individual interests, the Media Library also serves the purpose of bringing the diverse urban public together in the center of the city, and forming a positively-associated space in which they can experience each other. In the best case, this will make the Media Library a 'lively urban place', a venue for 'contact' between people of diverse colour, income, and interests. It could potentially become a place where the various 'counter-publics' of Oakland's diverse society can coexist, represent their positions, communicate, and contribute to the local public sphere.

NOTES

- 1 Oakland Museum was designed in 1968 by Roche Dinkeloo Associates.
- 2 Reyhan Harmanci. "Oakland's Emerging Arts Scene". *San Francisco Chronicle*, Sunday, May 27, 2007. <<http://sfgate.com/cgi-bin/article.cgi?f=/c/a/2007/05/27/PKGEIPMIG430.DTL>> accessed 07-06-15
- 3 Anne Stuhldreher. "Against Gentrification: Marcel Diallo sees a black cultural district where Oakland's the Bottoms neighborhood now stands" *San Francisco Chronicle*, Sunday, January 21, 2007. <<http://sfgate.com/cgi-bin/article.cgi?file=/c/a/2007/01/21/CMG93N6V7B1.DTL>> accessed 07-03-15
- 4 Black, Alistair. *A New History of the English Public Library: Social and Intellectual Contexts, 1850-1914*. London: Leicester University Press, 1996. 2.
- 5 Lefebvre, Henri. "The Production of Space". *Rethinking Architecture*. Leach, Neil (editor). London: Routledge, 1997. 140.
- 6 Abigail Van Slyck. *Free to All: Carnegie Libraries and the Transformation of American Culture, 1886-1917*. Doctor of Philosophy Dissertation, University of California, Berkeley, 1989. 229
- 7 Ibid, 229.
- 8 Black, *A New History*, 239.
- 9 Höfer, Candida. *Candida Hofer : Libraries*. Munich : Schirmer/Mosel, 2005.
- 10 Lefebvre, "The Production of Space," 142.
- 11 Balmound, Cecil, and Jannuzzi Smith. *Informal*. Munich: Prestel, 2002. p 71
- 12 DeYoung Museum was designed by Herzog & de Meuron in 2005. Landscape design was done by Hood Associates.

Design Drawings

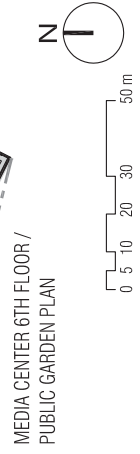

SITE & ROOF PLAN SCALE: 1:1000

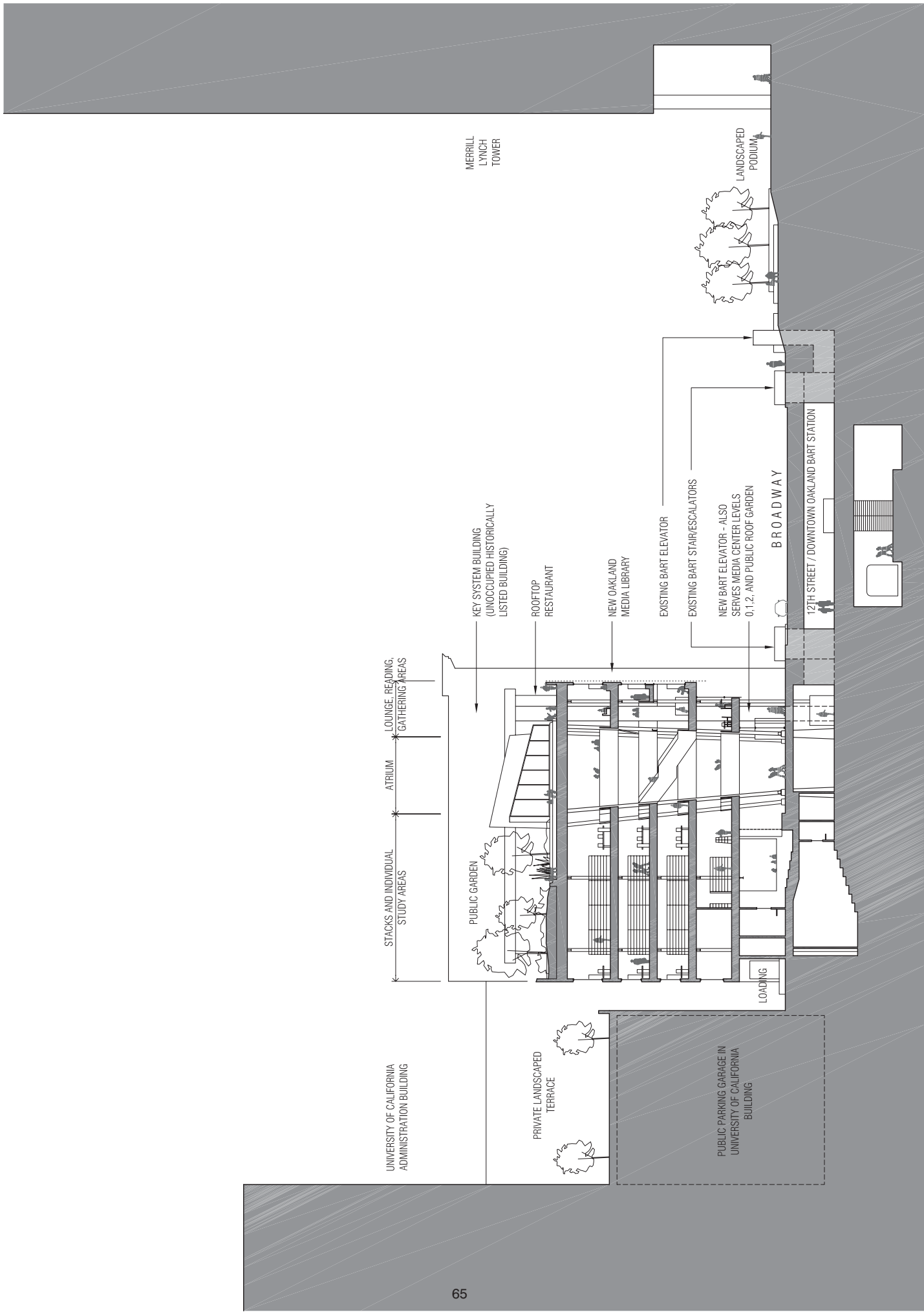

PUBLIC PARKING GARAGE IN BASE OF
UNIVERSITY OF CALIFORNIA
ADMINISTRATION BUILDING

A

B

C

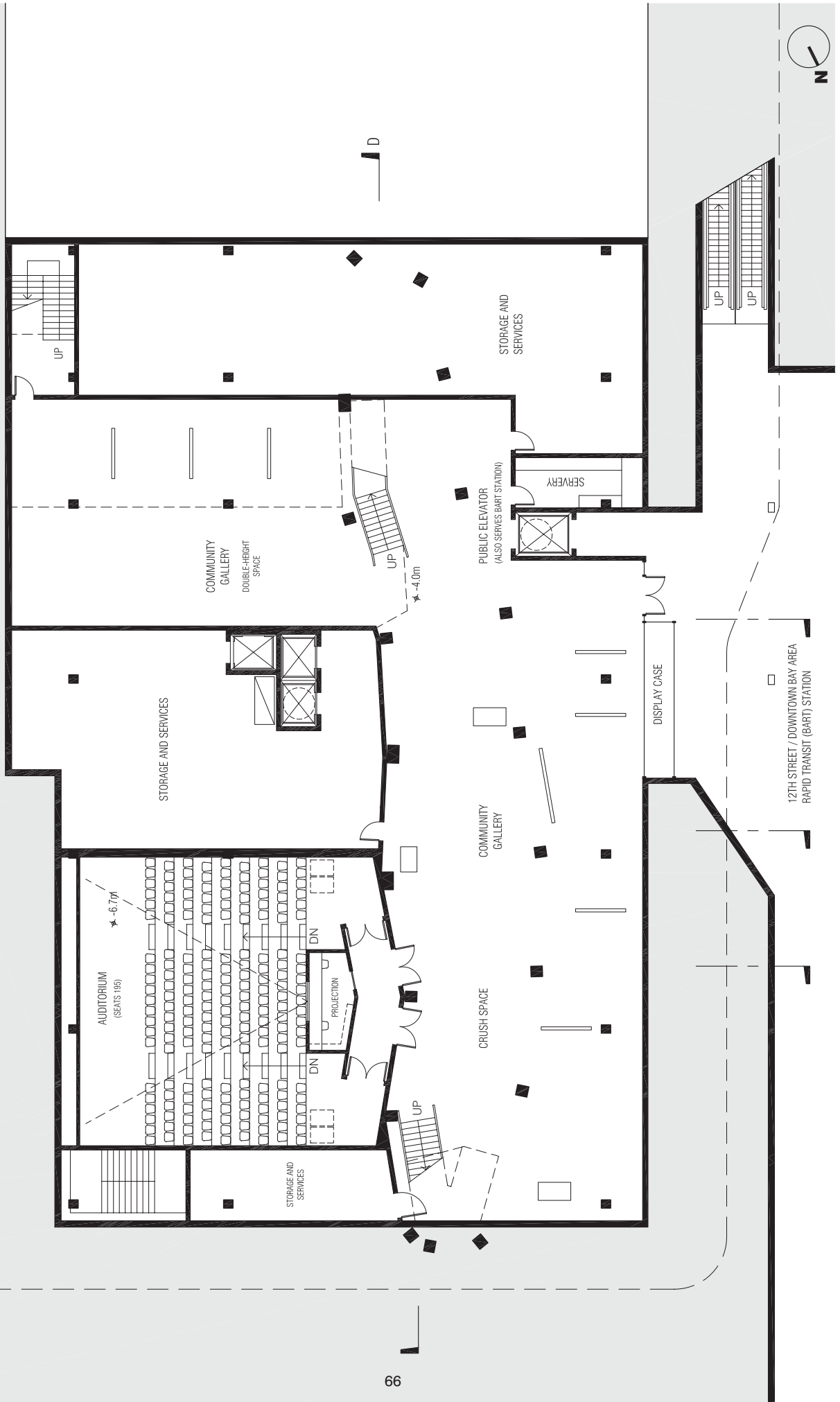

LOWER LEVEL PLAN - COMMUNITY GALLERY AND AUDITORIUM

SCALE: 1:250

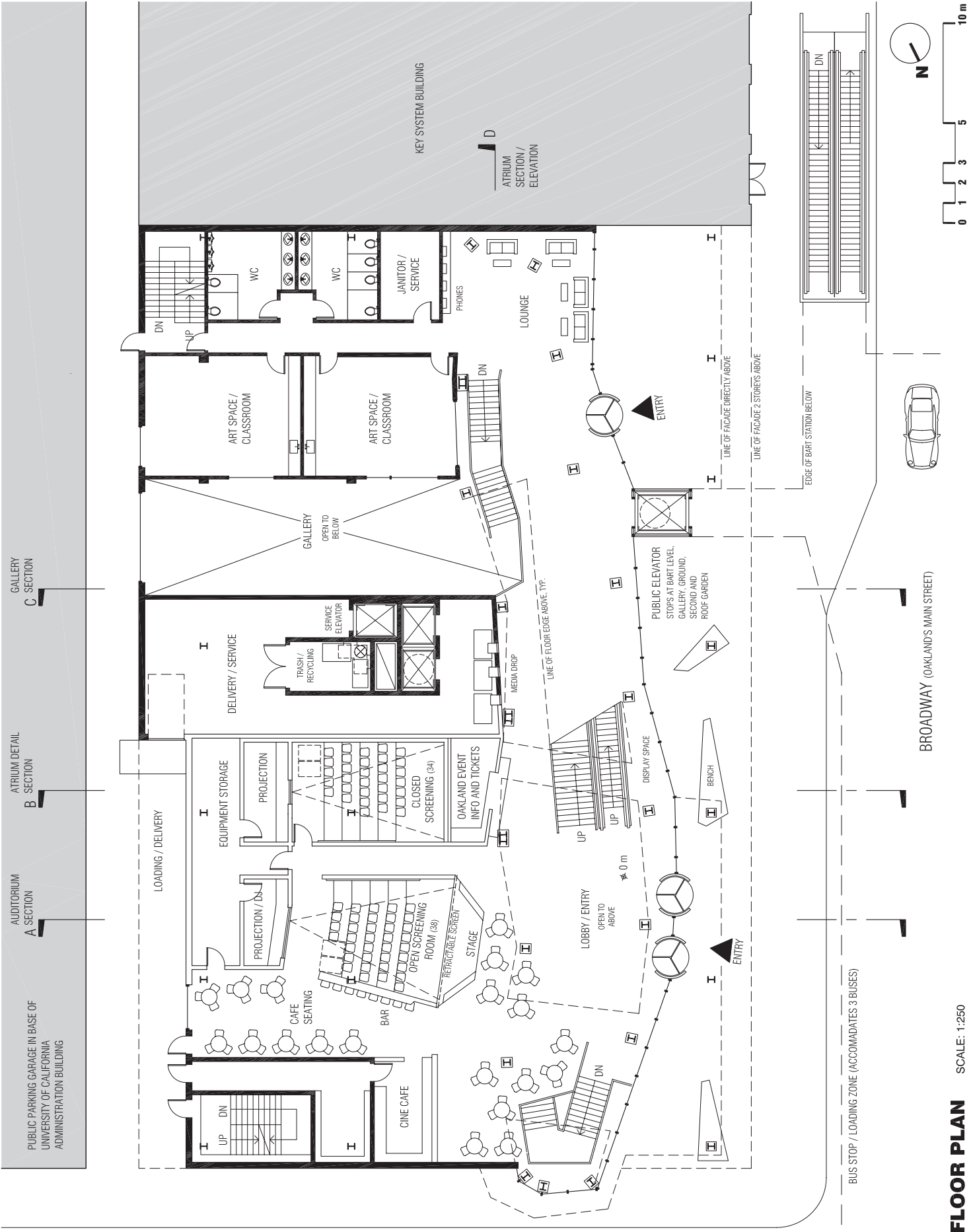

PUBLIC PARKING GARAGE IN BASE OF UNIVERSITY OF CALIFORNIA ADMINISTRATION BUILDING

AUDITORIUM A SECTION

ATRIUM DETAIL B SECTION

GALLERY C SECTION

KEY SYSTEM BUILDING

ATRIUM SECTION / ELEVATION

INTERIOR ELEVATION

12TH STREET

BUS STOP / LOADING ZONE (ACCOMMODATES 3 BUSES)

BROADWAY (OAKLAND'S MAIN STREET)

GROUND FLOOR PLAN

SCALE: 1:250

PUBLIC PARKING GARAGE IN BASE OF
UNIVERSITY OF CALIFORNIA
ADMINISTRATION BUILDING

A

B

C

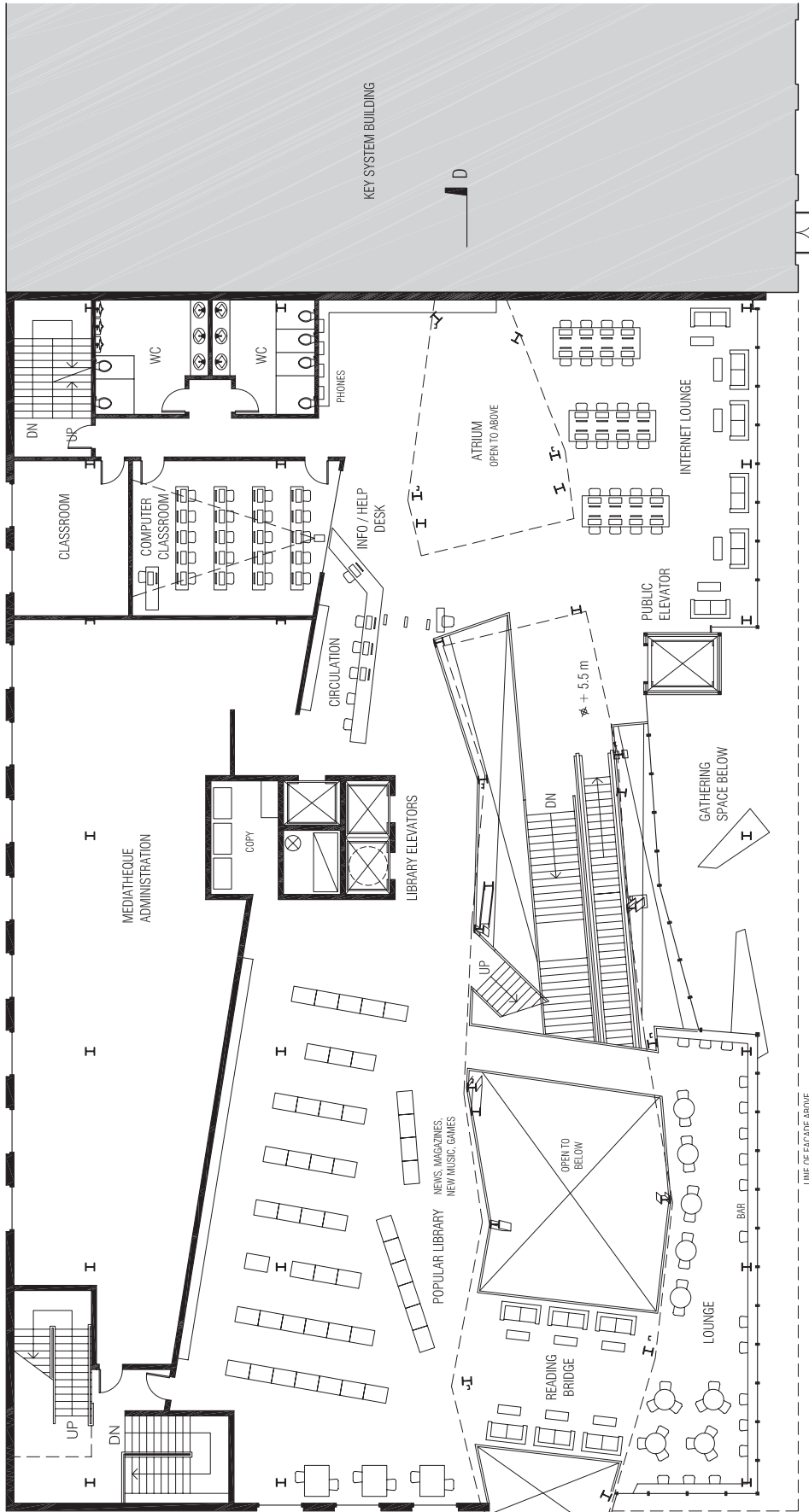

PUBLIC PARKING GARAGE IN BASE OF
UNIVERSITY OF CALIFORNIA
ADMINISTRATION BUILDING

A

B

C

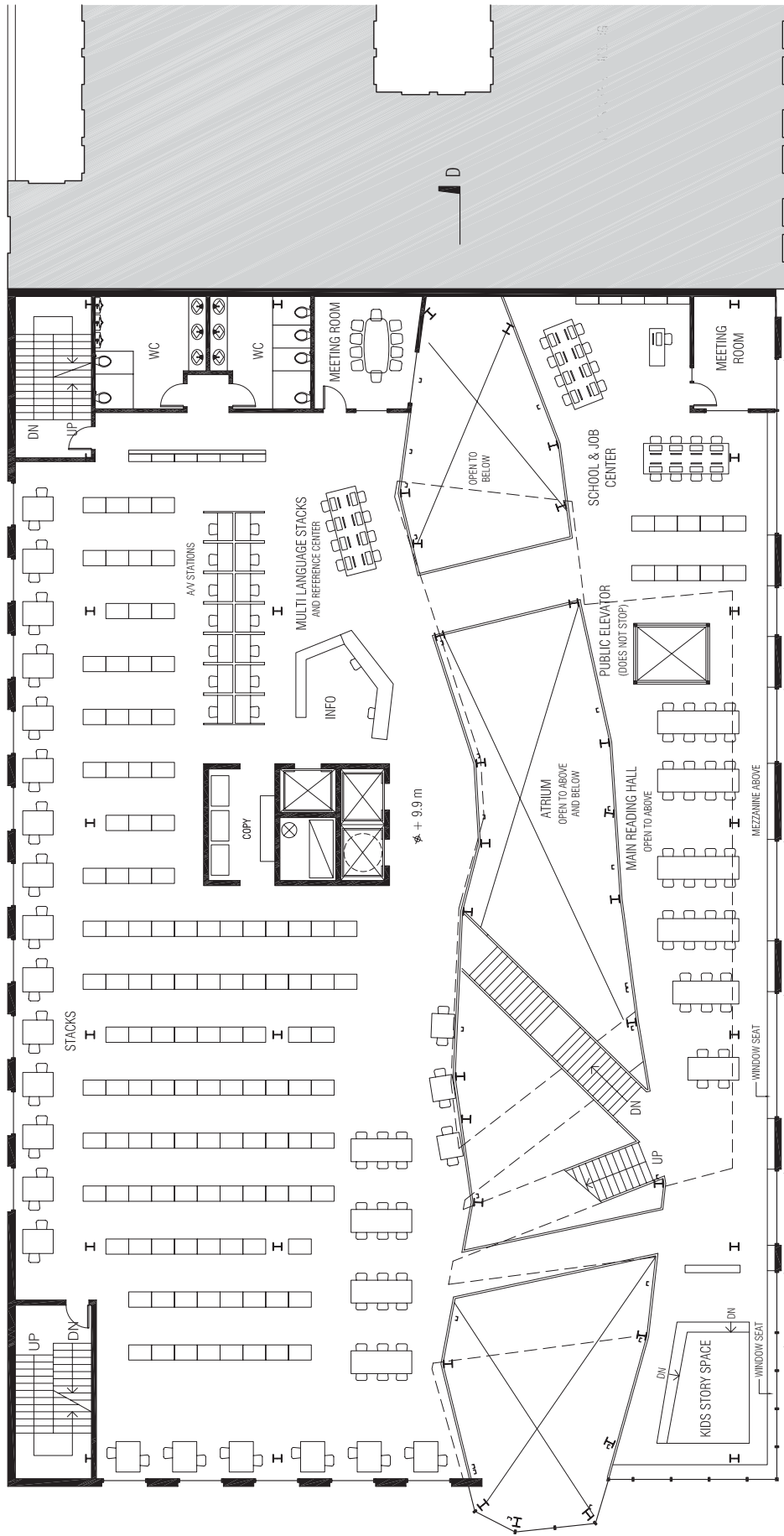

PUBLIC PARKING GARAGE IN BASE OF
UNIVERSITY OF CALIFORNIA
ADMINISTRATION BUILDING

A

B

C

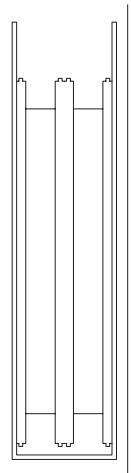
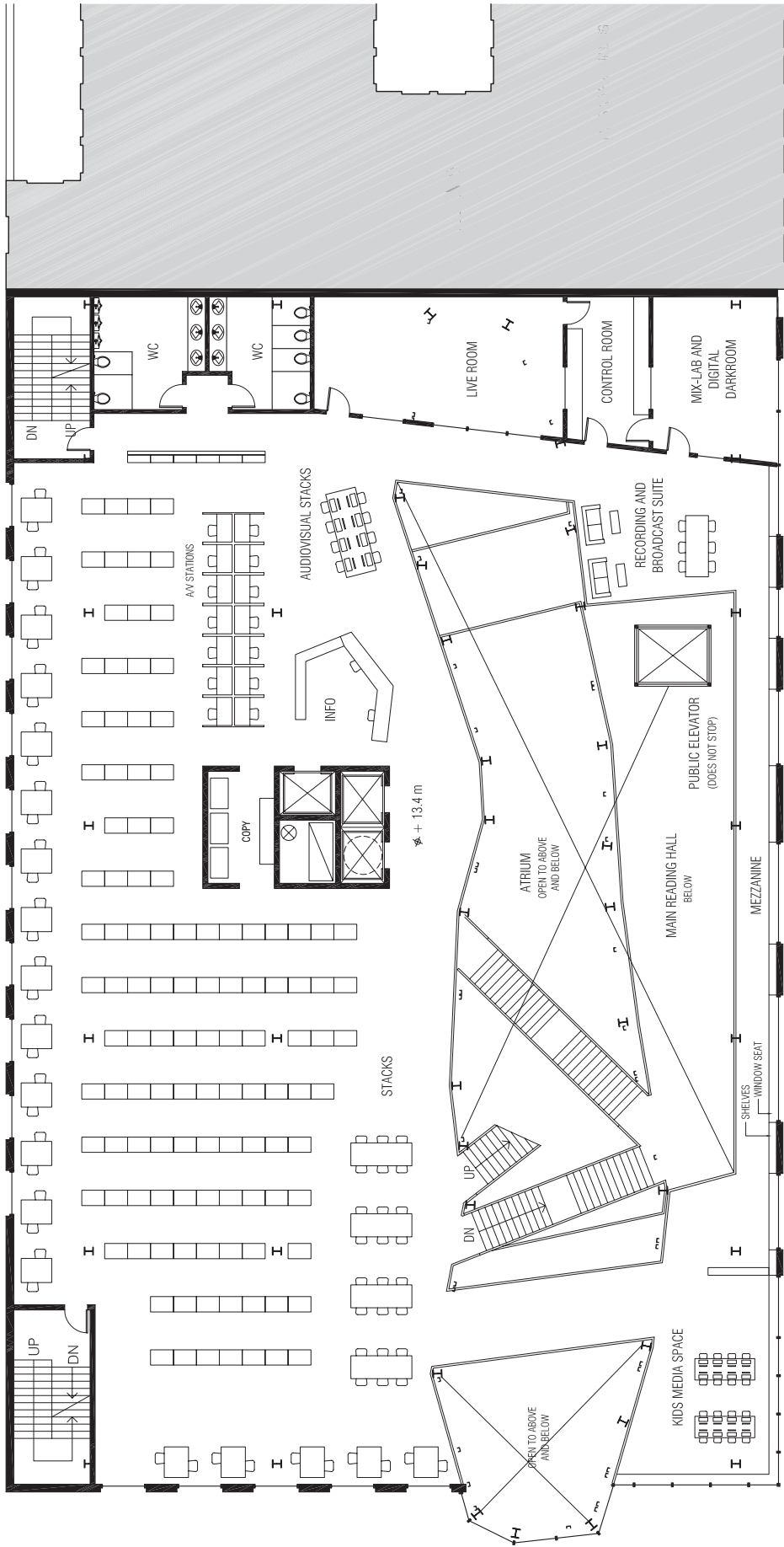

PRIVATE GARDEN TERRACE
UNIVERSITY OF CALIFORNIA
ADMINISTRATION BUILDING

A

B

C

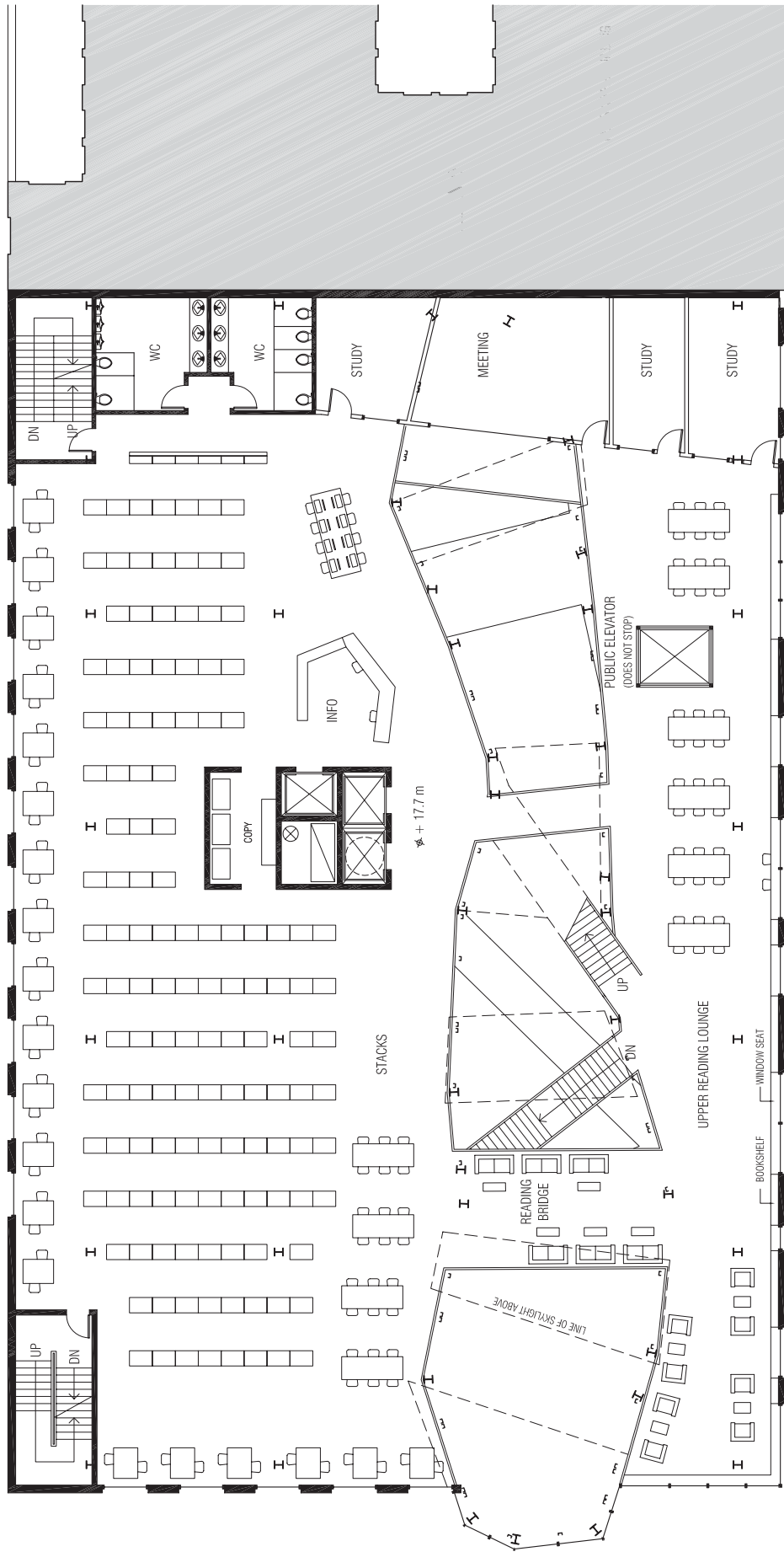

PUBLIC PARKING GARAGE IN BASE OF
UNIVERSITY OF CALIFORNIA
ADMINISTRATION BUILDING

C

B

A

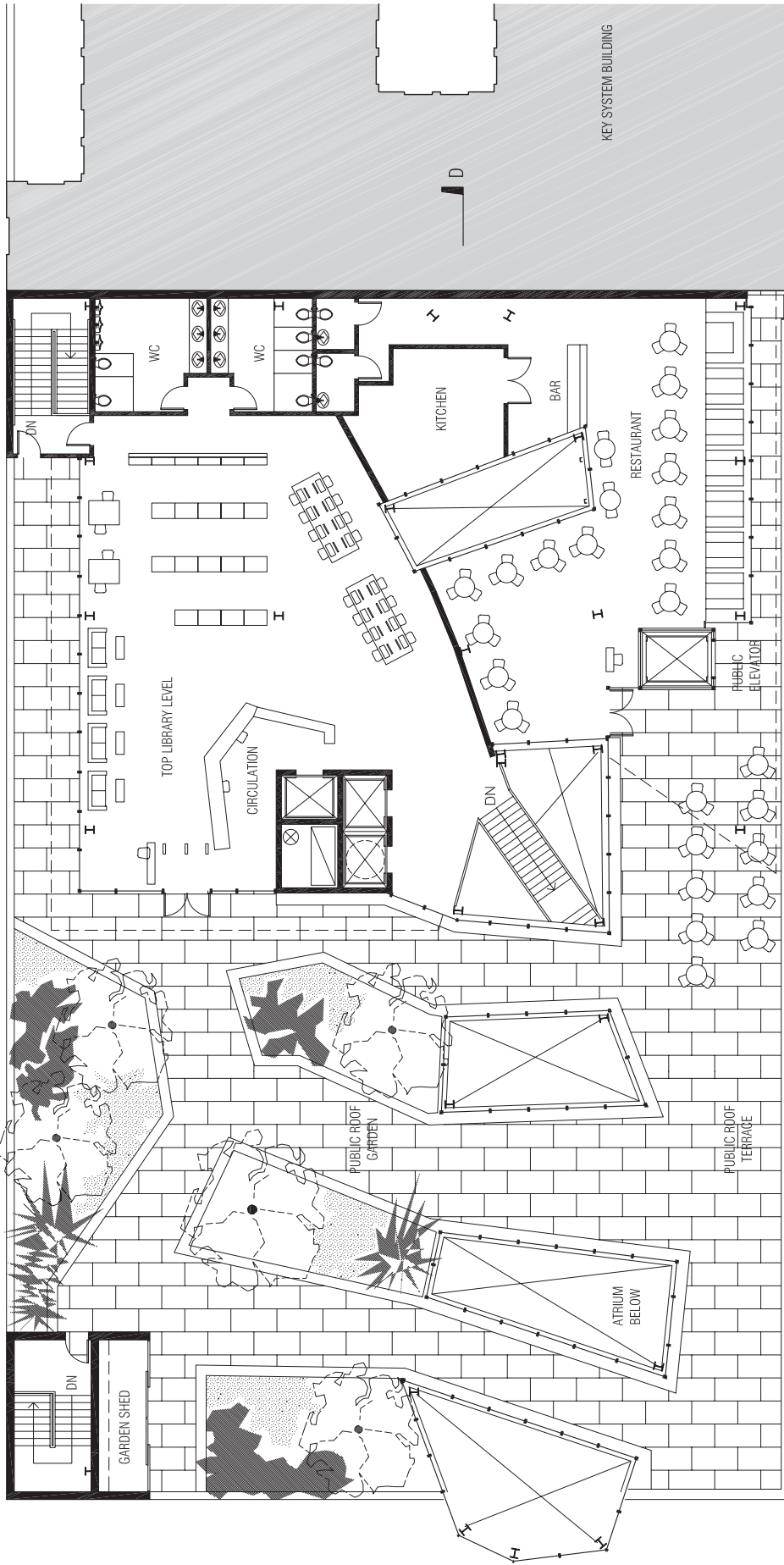

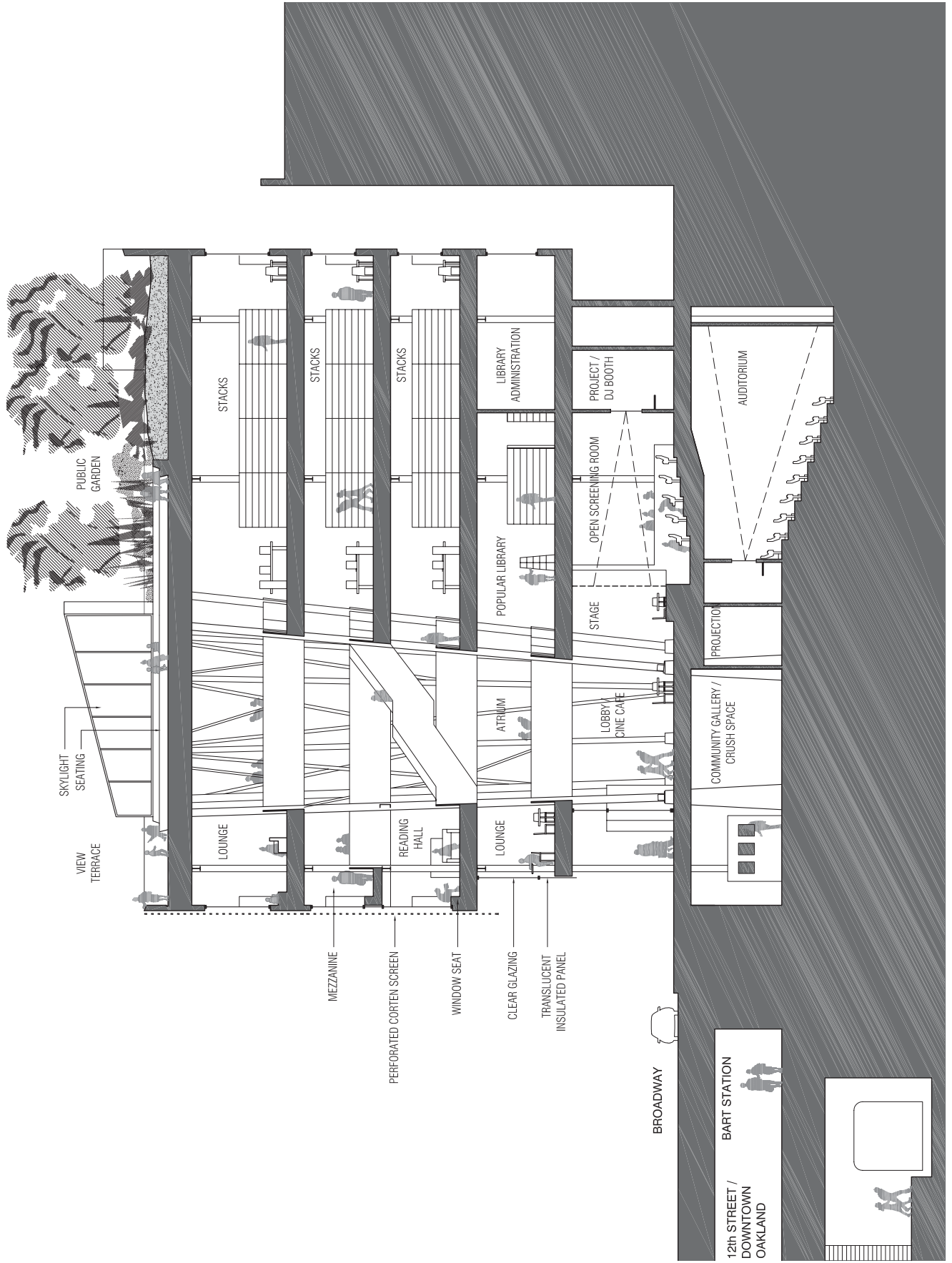

VIEW TERRACE
 SKYLIGHT SEATING
 PUBLIC GARDEN
 STACKS
 STACKS
 STACKS
 LOUNGE
 READING HALL
 LOUNGE
 POPULAR LIBRARY
 LIBRARY ADMINISTRATION
 PROJECT / DJ BOOTH
 OPEN SCREENING ROOM
 STAGE
 LOBBY / CINE CAFE
 COMMUNITY GALLERY / CRUSH SPACE
 PROJECTION
 AUDITORIUM

MEZZANINE
 PERFORATED CORTEN SCREEN
 WINDOW SEAT
 CLEAR GLAZING
 TRANSLUCENT INSULATED PANEL

BROADWAY
 BART STATION
 12th STREET / DOWNTOWN OAKLAND



SECTION A - AUDITORIUM SCALE: 1:250



SCALE: 1:250

SECTION C - GALLERY

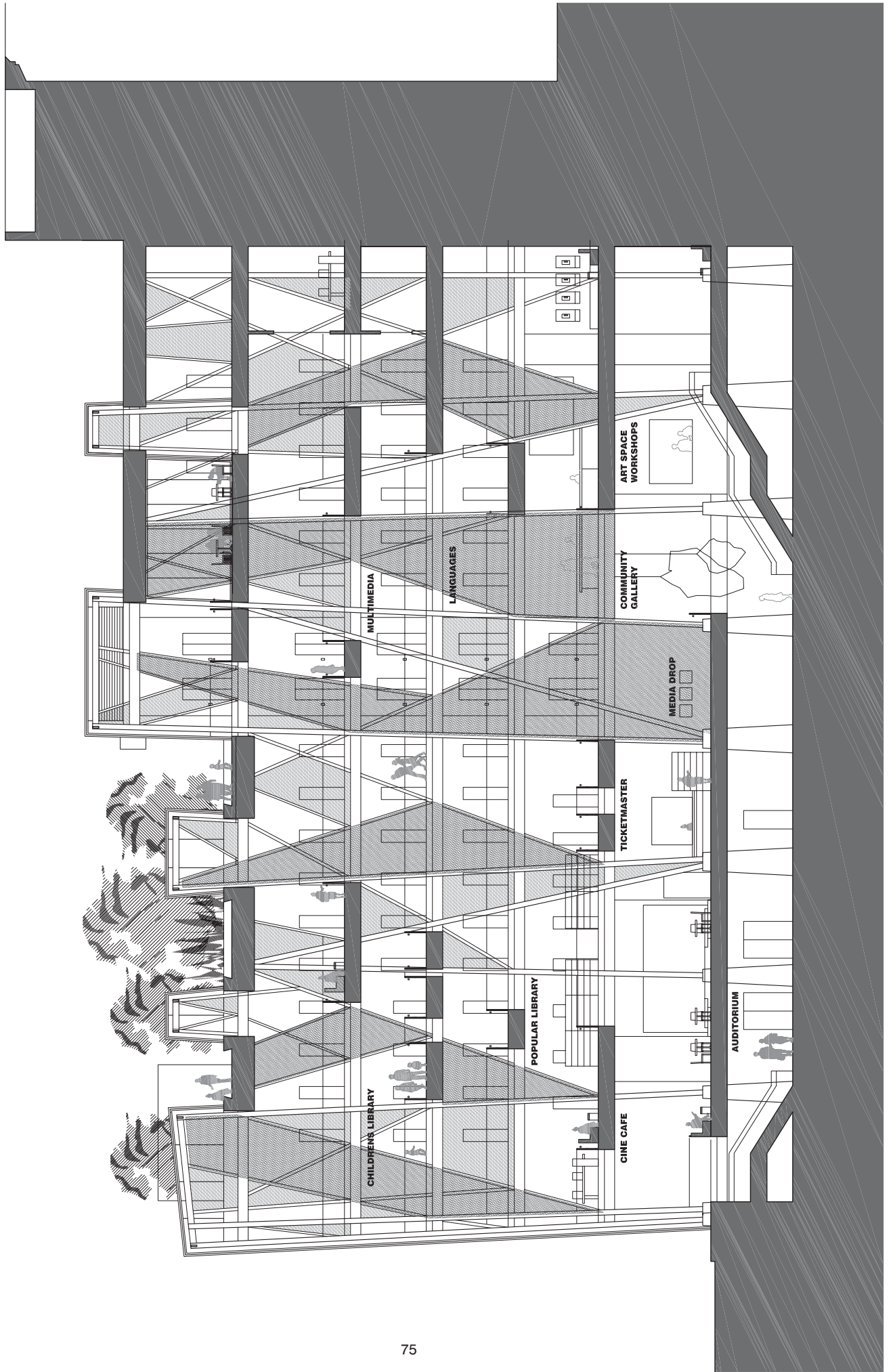

SCALE: 1:250

INTERIOR ELEVATION - THROUGH ATRIUM FACING STACKS

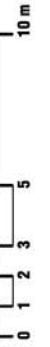
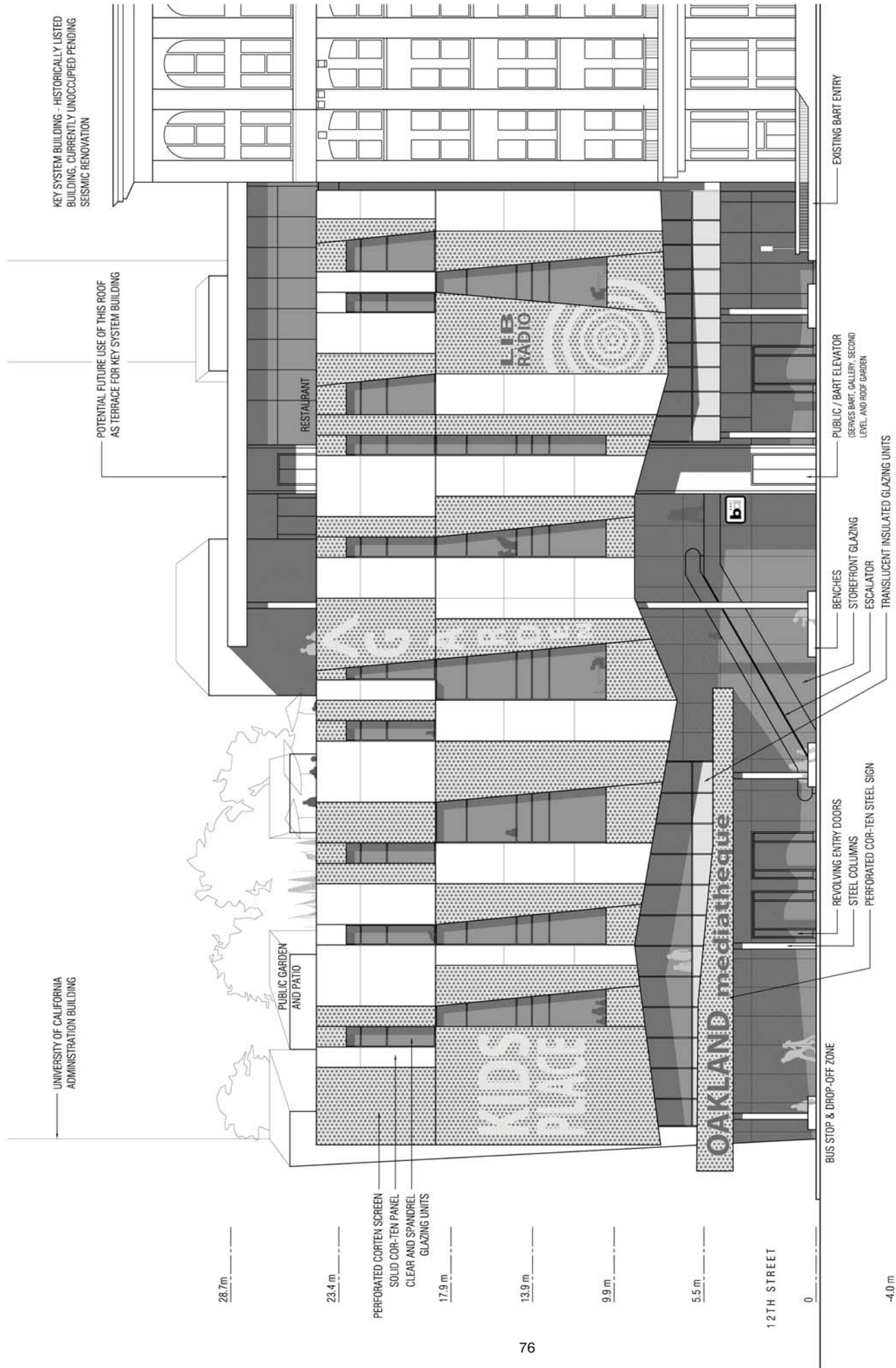

SCALE: 1:250

WEST ELEVATION - BROADWAY

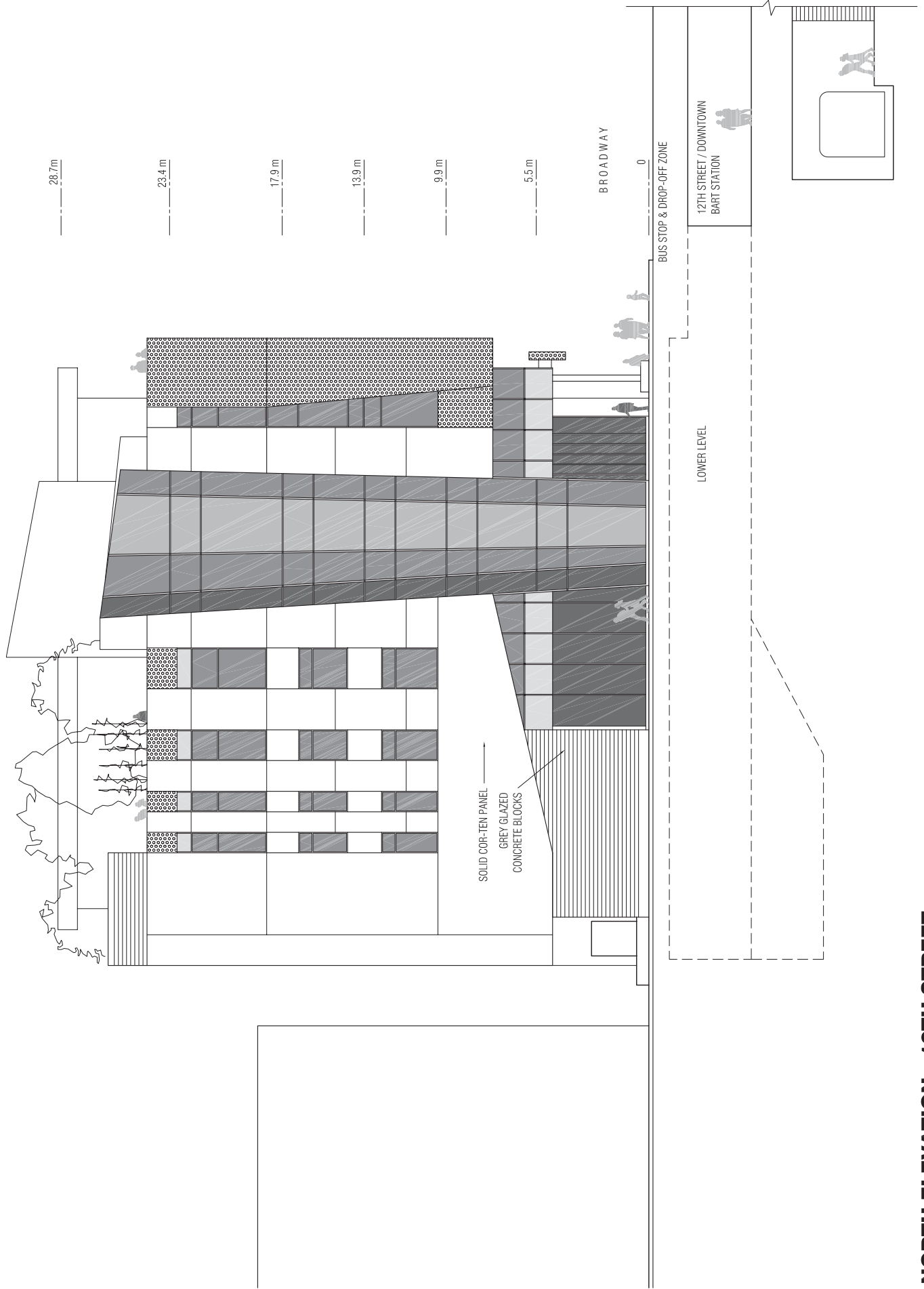

NORTH ELEVATION - 12TH STREET SCALE: 1:250

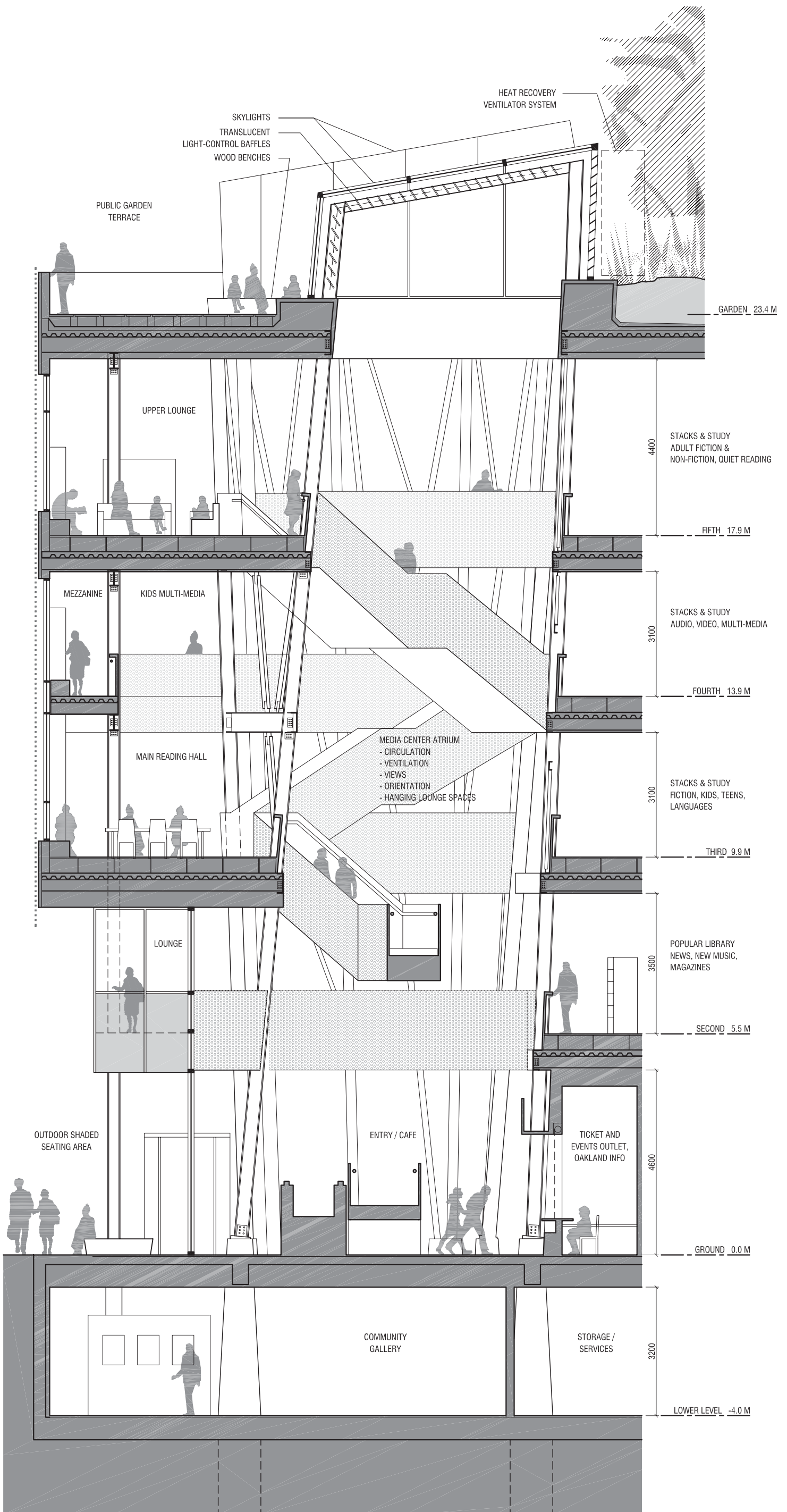

DETAIL - SECTION THROUGH ATRIUM FACING NORTH

SCALE: 1:100

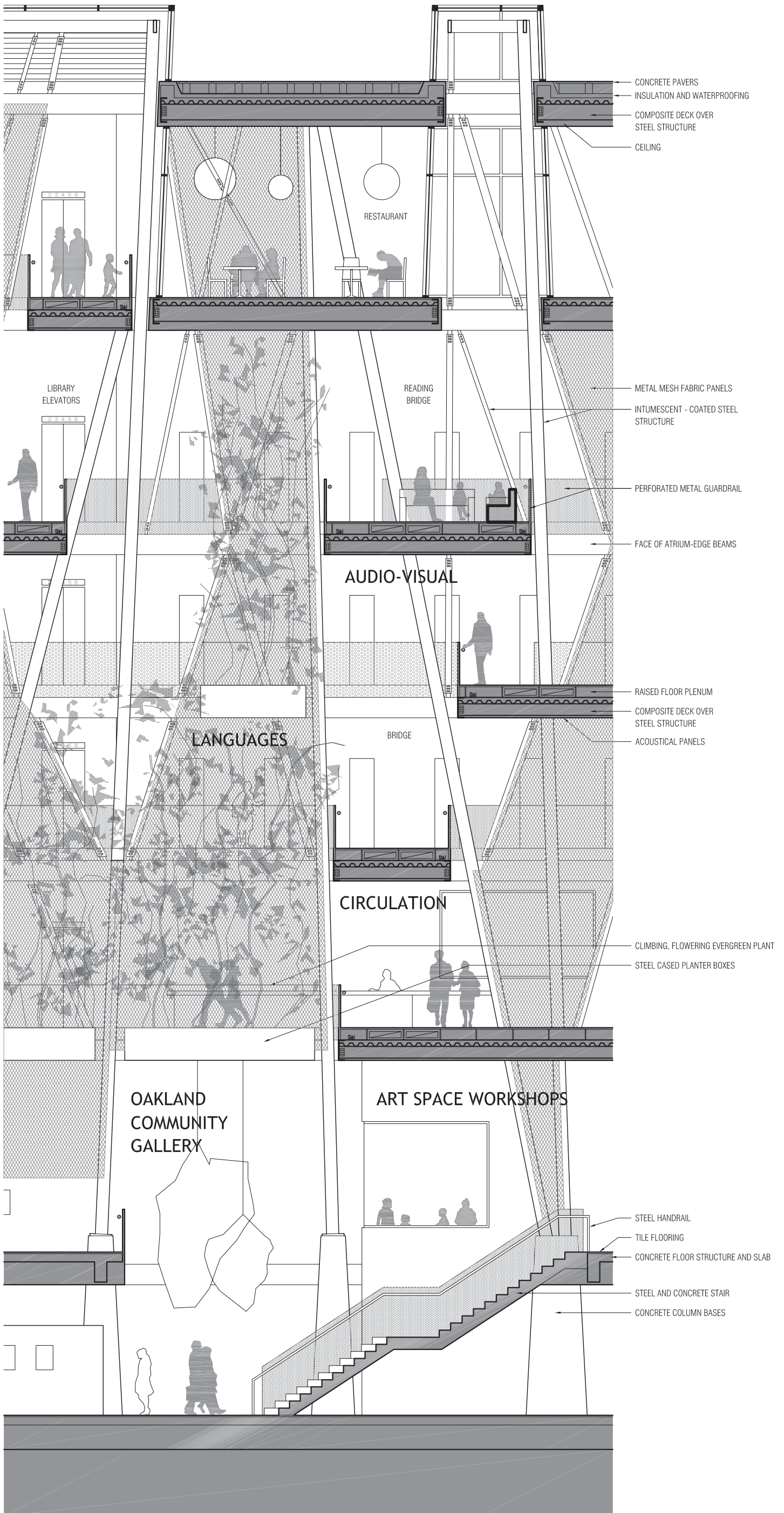

DETAIL - INTERIOR ELEVATION - ATRIUM FACING STACKS SCALE: 1:100

Appendices

IFLA / UNESCO Public Library Manifesto

1994

[English Version]

Freedom, prosperity and the development of society and of individuals are fundamental human values. They will only be attained through the ability of well-informed citizens to exercise their democratic rights and to play an active role in society. Constructive participation and the development of democracy depend on satisfactory education as well as on free and unlimited access to knowledge, thought, culture and information.

The public library, the local gateway to knowledge, provides a basic condition for lifelong learning, independent decision-making and cultural development of the individual and social groups. This Manifesto proclaims UNESCO's belief in the public library as a living force for education, culture and information, and as an essential agent for the fostering of peace and spiritual welfare through the minds of men and women.

UNESCO therefore encourages national and local governments to support and actively engage in the development of public libraries.

The Public Library

The public library is the local centre of information, making all kinds of knowledge and information readily available to its users.

The services of the public library are provided on the basis of equality of access for all, regardless of age, race, sex, religion, nationality, language or social status. Specific services and materials must be provided for those users who cannot, for whatever reason, use the regular services and materials, for example linguistic minorities, people with disabilities or people in hospital or prison.

All age groups must find material relevant to their needs. Collections and services have to include all types of appropriate media and modern technologies as well as traditional materials. High quality and relevance to local needs and conditions are fundamental. Material must reflect current trends and the evolution of society, as well as the memory of human endeavour and imagination.

Collections and services should not be subject to any form of ideological, political or religious censorship, nor commercial pressures.

Missions of the Public Library

The following key missions which relate to information, literacy, education and culture should be at the core of public library services:

1. creating and strengthening reading habits in children from an early age;
2. supporting both individual and self conducted education as well as formal education at all levels;
3. providing opportunities for personal creative development;
4. stimulating the imagination and creativity of children and young people;
5. promoting awareness of cultural heritage, appreciation of the arts, scientific achievements and innovations;
6. providing access to cultural expressions of all performing arts;
7. fostering inter-cultural dialogue and favouring cultural diversity;
8. supporting the oral tradition;
9. ensuring access for citizens to all sorts of community information;
10. providing adequate information services to local enterprises, associations and interest groups;
11. facilitating the development of information and computer literacy skills;
12. supporting and participating in literacy activities and programmes for all age groups, and initiating such activities if necessary.

APPENDIX A: IFLA / UNESCO PUBLIC LIBRARY MANIFESTO

Funding, legislation and networks

The public library shall in principle be free of charge.

The public library shall in principle be free of charge. The public library is the responsibility of local and national authorities. It must be supported by specific legislation and financed by national and local governments. It has to be an essential component of any long-term strategy for culture, information provision, literacy and education.

To ensure nationwide library coordination and cooperation, legislation and strategic plans must also define and promote a national library network based on agreed standards of service.

The public library network must be designed in relation to national, regional, research and special libraries as well as libraries in schools, colleges and universities.

Operation and management

A clear policy must be formulated, defining objectives, priorities and services in relation to the local community needs. The public library has to be organized effectively and professional standards of operation must be maintained.

Cooperation with relevant partners - for example, user groups and other professionals at local, regional, national as well as international level- has to be ensured.

Services have to be physically accessible to all members of the community. This requires well situated library buildings, good reading and study facilities, as well as relevant technologies and sufficient opening hours convenient to the users. It equally implies outreach services for those unable to visit the library.

The library services must be adapted to the different needs of communities in rural and urban areas.

The librarian is an active intermediary between users and resources. Professional and continuing education of the librarian is indispensable to ensure adequate services.

Outreach and user education programmes have to be provided to help users benefit from all the resources.

Implementing the Manifesto

Decision makers at national and local levels and the library community at large, around the world, are hereby urged to implement the principles expressed in this Manifesto.

The Manifesto is prepared in cooperation with the International Federation of Library Associations and Institutions (IFLA).

<<http://www.ifla.org/VII/s8/unesco/eng.htm>> accessed August 25 2007

A

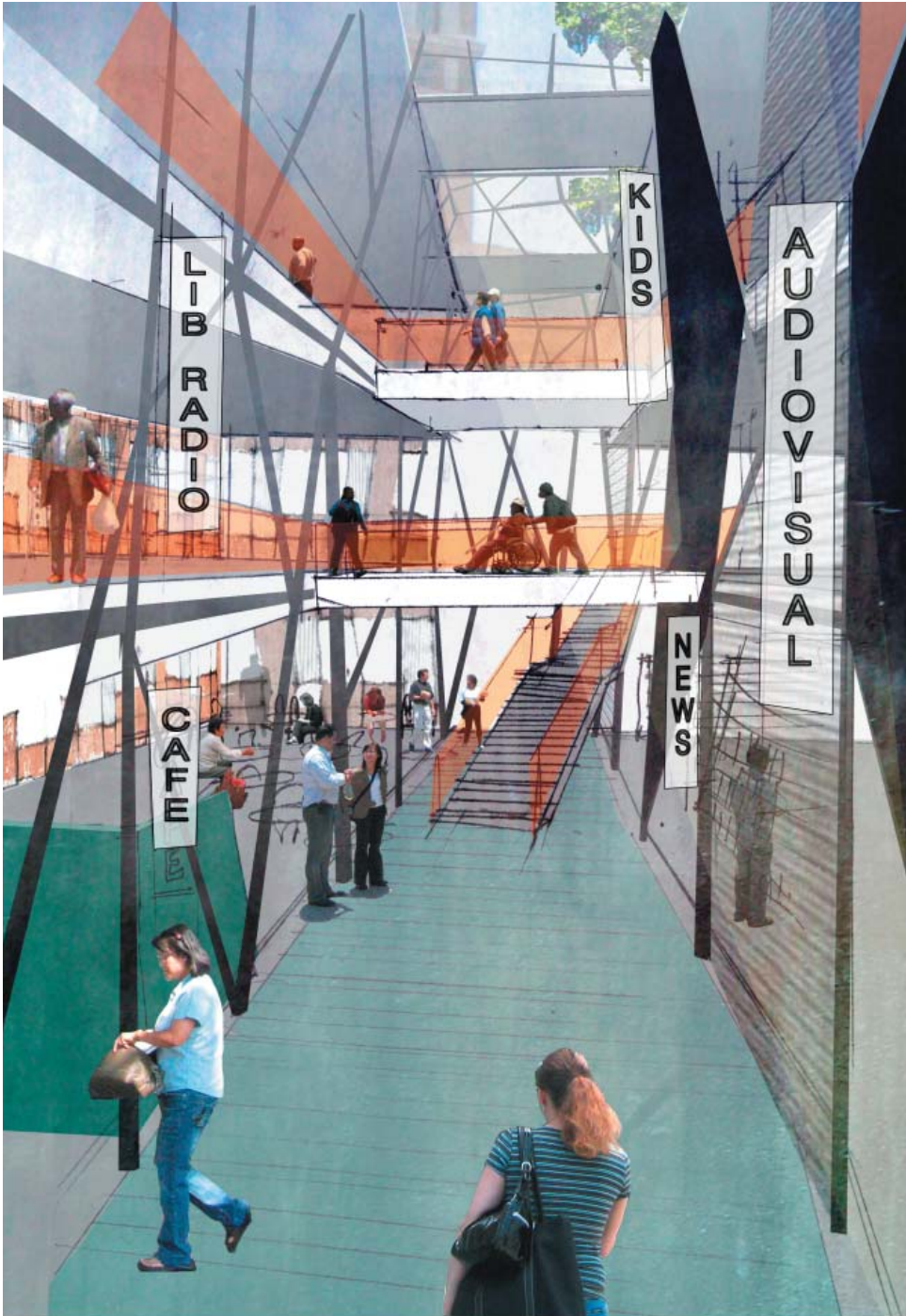

Oakland MEDIATHEQUE: A Place to Re-Read City and Public

This public multi-media library for Oakland, California is a place where a positive sense of 'Public' can be fostered, where racism and oppression can be challenged, and where opportunities for learning and participation in media production are provided to the public.

The design springs from a reading of three contexts surrounding the Mediathèque: the physical environment of the city and region, Oakland's particular socioeconomic and cultural milieu, and concepts of virtual and physical public space in the city.

In response to these contexts, the Mediathèque is envisioned as a layered construction of public spaces, public programs, and public representations of the city. The city's history of stigma (created by racism) makes it a place where issues of perception must be explored. As a space of media consumption and creation, the Mediathèque is the ideal program in which to explore these issues.

Seismic / Environmental Context

The Bay Area is an extremely seismically active zone which supports a commuter metropolis that has overextended its reach for resources. Water comes from the Sierra Nevada mountains 200 miles distant, and power is bought from Oregon and Washington. Suburban development proceeds rapidly, consuming natural surroundings and increasing resource needs.

The Parti is a sketch of a shear element which structures the new building and re-structures the historic building on the site. This structure forms the space of movement in the building. Symbolic and practical, it supports and enriches the existing Oakland, and suggests and new dynamic vision for the future.



The branching steel lattice structure provides support, shear resistance, ventilation, daylighting, and holds the building's vertical circulation. Central to the design is the idea that a single ambiguous element can function as structure, infrastructure, and aesthetic.

Social / Public Context

Oakland has a long history of diversity. It has been both a welcoming home to minorities and a scene of conflict related to this diversity. In this social context the design considers a wide range of issues regarding the public realm: how public programs can create a more equal society, how a positive sense of a large diverse public can be fostered, and what facade, architectural and aesthetics can represent a public of increasingly diverse skin colour, beliefs, language, and lifestyle.

The program consists of a series of public spaces and programmes that encourage chance encounters, opportunities for learning, interaction, and self-representation. The positive atmosphere of this new public space will foster a positive sense of the public.

Virtual / Perceptual Context

Increasingly we are leading more and more of our lives in front of computer screens. While we participate in the 'virtual' realm of cyberspace, we still walk dogs, meet friends in cafes; participate in the physical public spaces of our cities. In contemporary public space, these two public realms; the virtual and the physical, overlap.

At the community scale, there are strong senses of identity and cohesion among the black, Latino, and Asian communities, but a larger, city-wide sense of identity seems to be lacking.

The stigma that has plagued Oakland and the problem of racism and other forms of oppression of the 'other' are very related to perception. For the city to get past this, it is crucial for people to question their perceptions, question the way the media portrays the world, and learn to 'see each other in a different light'.

Architecturally, this translates as ambiguity—the elements of the mediathèque are designed to be multi-functional, experientially multiple, and complex, while holding together with a sense of unity. Ambiguous elements demand consideration, interpretation, and change as you move past them.

The architecture of the mediathèque is a frame or filter through which to see the city. This design provokes a re-perceiving of public space and the form of architecture appropriate to a diverse public.

Mediathèque Program:

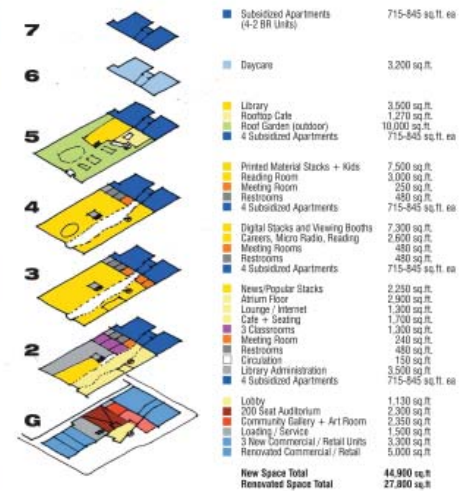

re READ

re EVALUATE

re VITALIZE

re INTERPRET

APPENDIX B: COMPETITION PANELS

These panels represent a competition entry for the ACSA/AISC Student Design Competition 2006-07. The competition “allows students to explore the many varied functional and aesthetic uses for steel as a building material.” This project was entered into CATEGORY II, ‘open’, which allowed open choice of site and program, but stipulated that “steel should be used as the primary structural material.” The panels were 20” x 20”.

B



San Francisco Bay Area
1 San Francisco 2 Oakland 3 Berkeley 4 Marin 5 Fremont 6 San Jose



Oakland Downtown

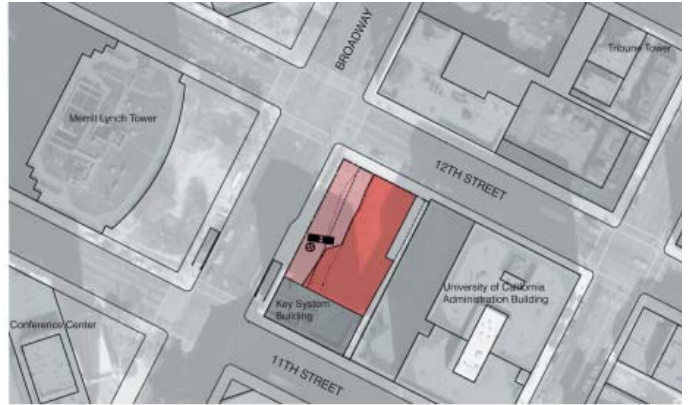

Site Plan

Scale: 1:1000



CONTEXTS



High Seismic Risk

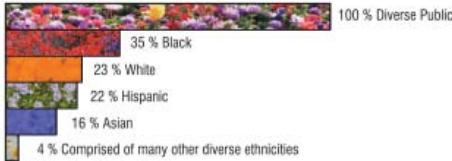

Multicultural Population



Experiential / Sensual Qualities of Downtown

RESPONSE



Structure: Branching Shear Lattice

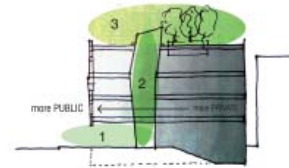

Program: Layered Public Spaces

1 Sidewalk Public Space 2 Mediatheque Atrium 3 Roof Garden

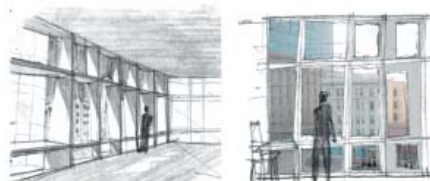

Aesthetic: Ambiguous, Texturally Rich, Environmentally Responsive



re EVALUATE re VITALIZE The Downtown, existing urban fabric, the public realm

Oakland MEDIATHEQUE
A Place to Re-Read City and Public

C

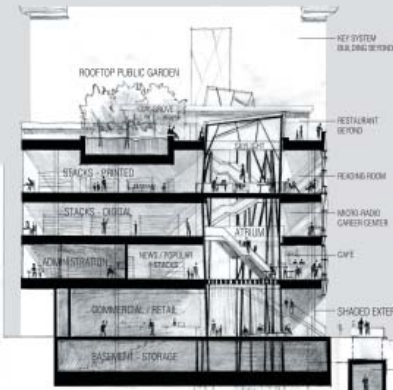

A Cross Section 1:300

*the Atrium is a space of view, movement, connection;
it personifies the dynamism of the mediathèque*

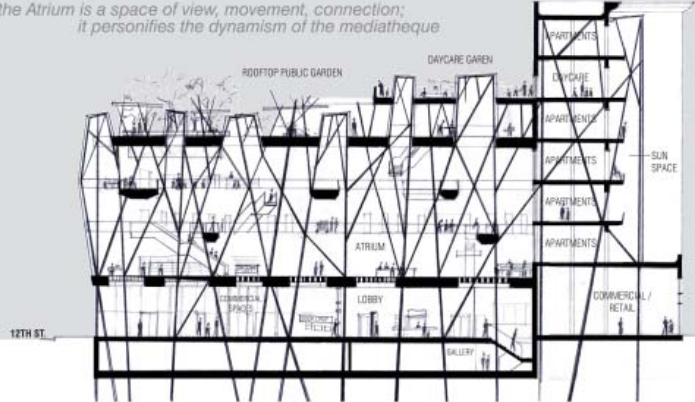

B Section / Elevation at Atrium 1:300



Ground Floor Plan 1:300

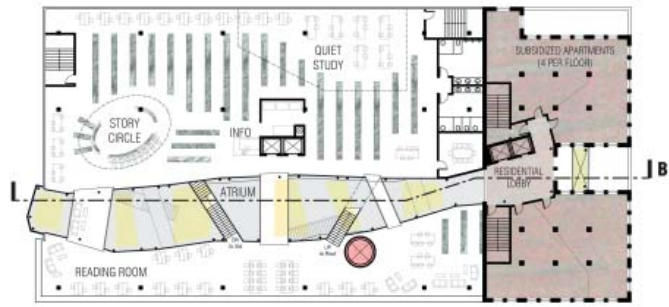

Fourth Floor Plan 1:300
Fourth is the Printed Media Floor - Third floor is similar but holds digital and audio-visual media



Second Floor Plan 1:300
This is the first Library Level

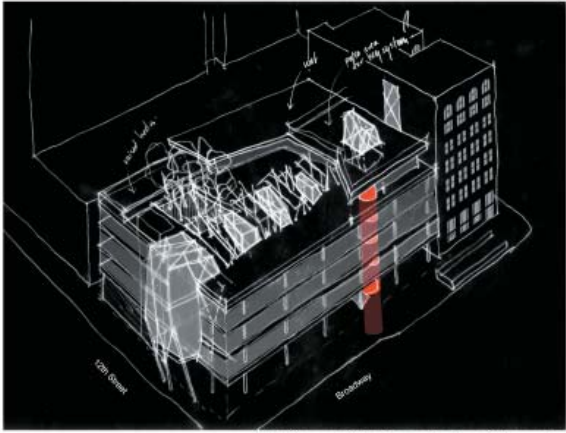

Night View - skylights become lanterns in the garden

re READ

The program and function of the public library as a set of urban public spaces

Oakland MEDIATHEQUE
A Place to Re-Read City and Public

ROOF / GARDEN

- New Public Space for Downtown
- Different viewpoint onto city
- Outdoor reading rooms
- Playspace for Daycare

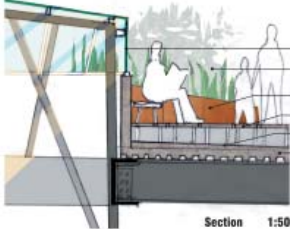

Section 1:50

- Tempered Glass Skylight
- Succulents and other drought resistant plants
- Corten Edged Planters
- Pedestal Planters
- Sloped topping to drain
- Concrete on Acoustical Metal Deck

SKIN

- Sun control, view modulation (on West Facade)
- Deep section creates shadow, play and textural richness
- Rigid curtain wall prevents glass breakage in earthquake



Elevation

Section 1:50

- Intersect light
- Direct light
- Corten Steel Curtain Wall mullions and spandrel panels
- Operable window with screen
- Low-E double paned glazing units with plastic safety film
- Recycled wood desktop

SHEAR

- Provides shear resistance
- Brings light into building
- Views to all parts of building
- Space of circulation and services
- Structures new, and Restructures existing

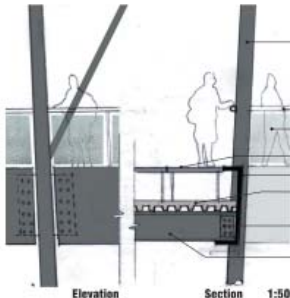

Elevation

Section 1:50

- Intumescent painted HSS Columns
- Steel Guardrail
- Metal Mesh Guardrail
- Raised Floor System
- C Channel (acts as smoke baffle)
- Concrete on Acoustical Metal Deck
- Bolted Connections to pre-welded ribs
- WF Beams

SUPPORT

- Raised floor brings air, data and electricity to all spaces
- Flexible / changeable
- HSS columns at perimeter



Plan

Section 1:50

- Power/Data Outlets
- Floor Supply Air Register
- Raised Floor Panels with Rubber Flooring
- Plenum with electrical, data and air supply
- Concrete on Acoustical Metal Deck

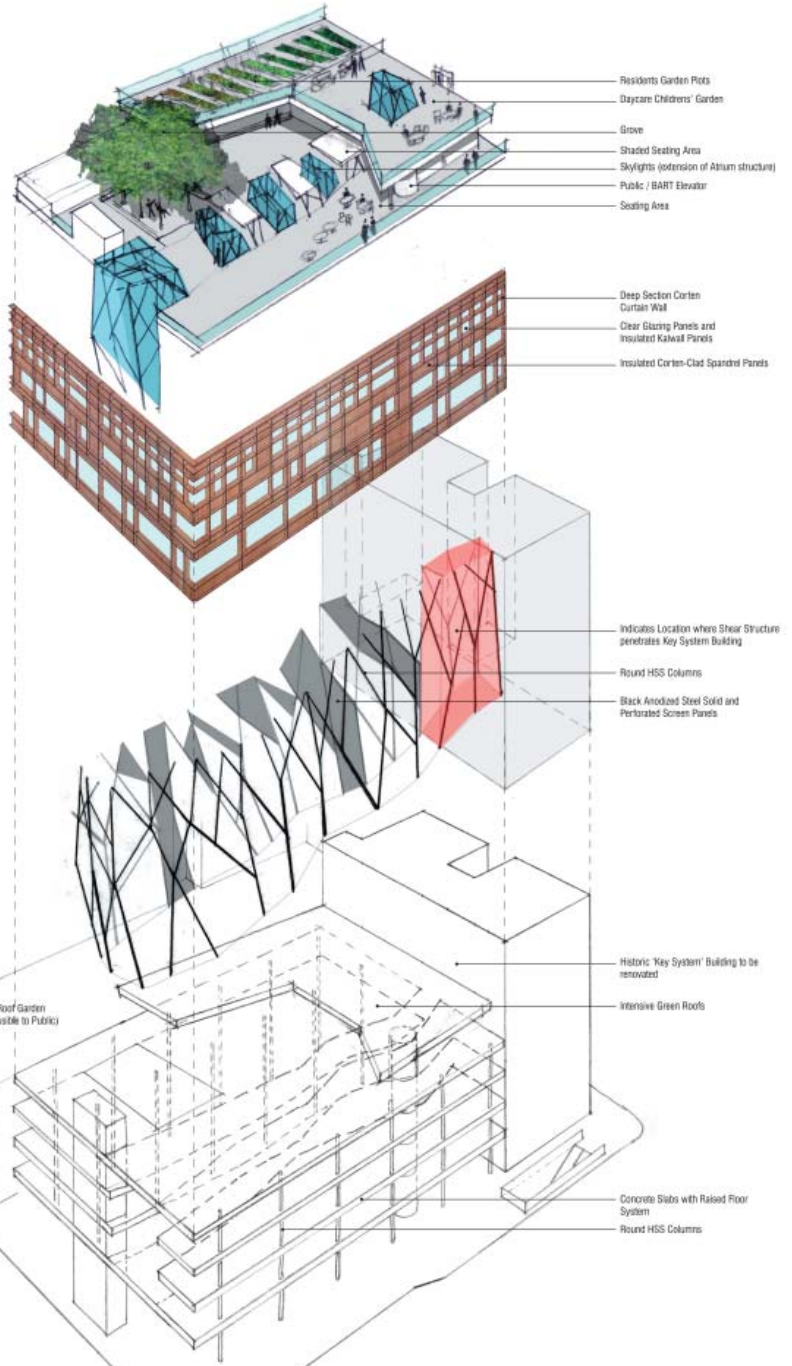

- Residents Garden Plots
- Daycare Children's Garden
- Grove
- Shaded Seating Area
- Skylights (extension of Atrium structure)
- Public / BART Elevator
- Seating Area

- Deep Section Corten Curtain Wall
- Clear Glazing Panels and Insulated Kawneer Panels
- Insulated Corten-Clad Spandrel Panels

- Indicates Location where Shear Structure penetrates Key System Building
- Round HSS Columns
- Black Anodized Steel Solid and Perforated Screen Panels

- Historic 'Key System' Building to be renovated
- Intensive Green Roofs

- Concrete Slabs with Raised Floor System
- Round HSS Columns

re **INTERPRET** The meaning of a wall, the sensual qualities of steel

Oakland MEDIATHEQUE
A Place to Re-Read City and Public

BROADWAY

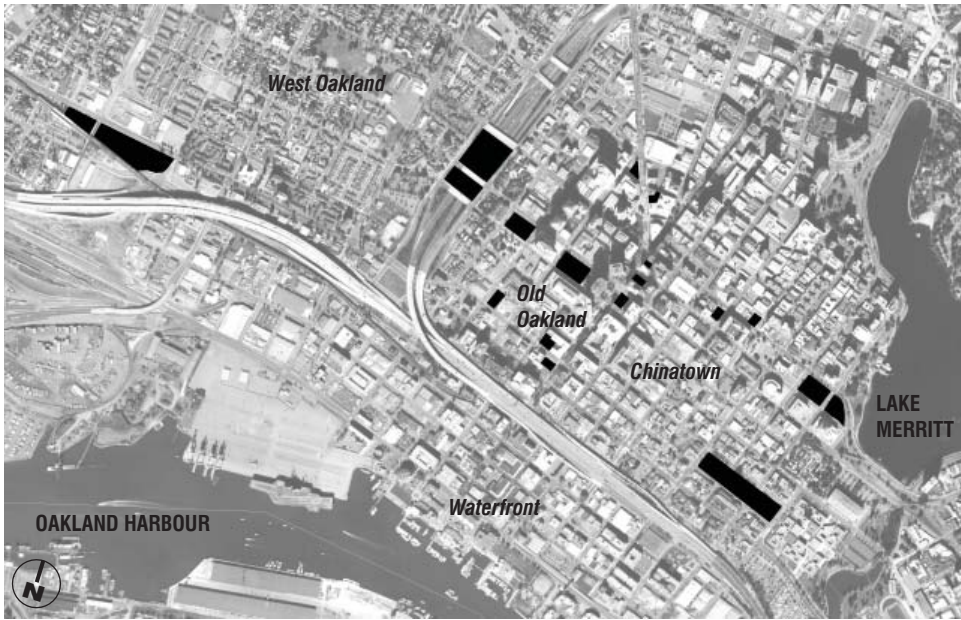

Map of Sites Considered

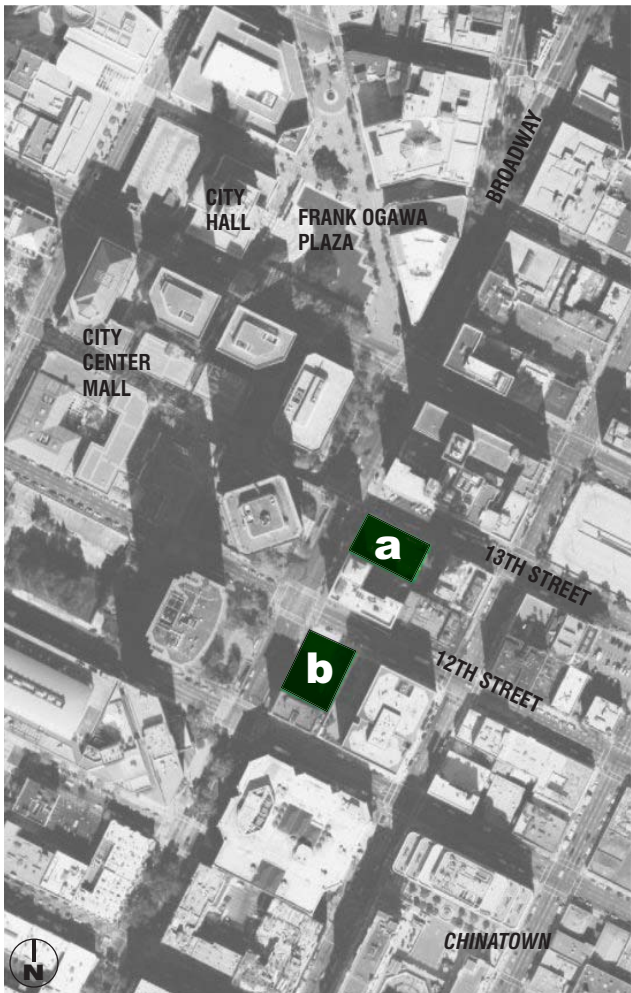

Broadway Sites

Site A - Broadway @ 13th Street

1. Existing 2-storey building
2. Tribune Tower - Oakland city landmark, recently renovated and rented
3. Existing Retail Spaces: Burger King, Buongiorno Pizza, Goodwill
4. BART (Bay Area Rapid Transit) entrance - accesses the 12th street 'Downtown' station
5. Broadway - Oakland's Main Street
6. Adjacent historic building stock, in general good quality, and underutilized
7. Potential Location for new urban public space, on main street, adjacent Tribune tower and historic buildings, with views to downtown surroundings

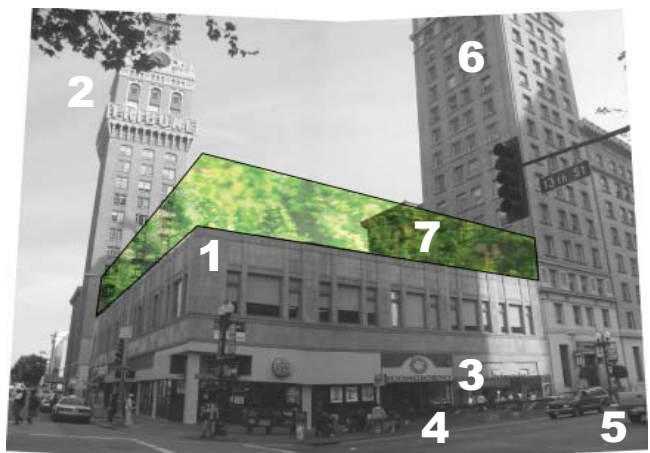

Site A - Broadway @ 13th Street

SITE SELECTION:

central, connected, engaged in urban fabric

The project began with several days of walking downtown Oakland; taking in the sunshine, chinese food, following pedestrian walkways and examining the city fabric.

After investigating several potential sites, ranging quite widely from the western highway edge and near the West Oakland BART station, to Lake Merritt shore on the eastern edge of downtown, I narrowed the choice to two potential sites located centrally, on Broadway, Oakland's main street.

Site B is chosen for its size, and its location on Broadway, in a place along the street between the bustle of the City Center Mall, to the north, and the shopping streets in Chinatown and Old Oakland, to the south.

Site B - Broadway @ 12th Street:

- 1. University of California Administration Building with patio at 5th floor adjacent site
- 2. Historically listed 'Key System' building unoccupied, in need of seismic upgrade.
- 3. Site - Potential for 4-5 storey building with public roof garden space above
- 4. BART (Bay Area Rapid Transit) entrance - accesses the 12th street 'Downtown' station
- 5. Broadway - Oakland Main Street
- 6. Potential for promotion of street level retail spaces along Broadway, within adjacent building and new Mediatheque

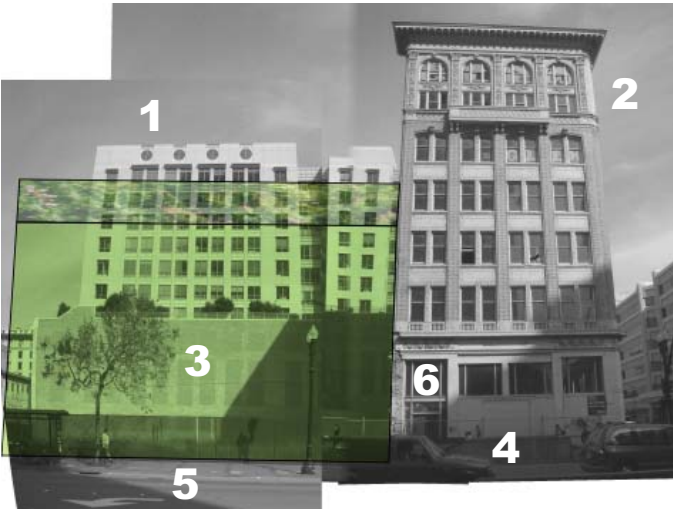

Site B - Broadway @ 12th Street

IMAGE CREDITS

All images by author unless listed and credited here.

1 OAKLAND URBAN HISTORY

##	Name	Page
1.1	San Francisco Bay Area - County and City Populations Aerial Photo (modified by author) from Google Earth < http://earth.google.com/ > City and County Population Data from Bay Area Census < http://www.bayareacensus.ca.gov/ >	2
1.2	Panorama of Oakland (1908) Oakland California Panoramic Photo Gallery < http://www.hellooakland.com/Images/Panoramic/thumb_4212005Oakland_6a17764r.jpg >	3
1.3	Original Oakland City Plan (1850) Julius Kellersberger's Map of Oakland Mel Scott. <i>The San Francisco Bay Area: A Metropolis in Perspective</i> . Berkeley : University of California Press, 1985. 5.	3
1.4	Pastoral Rendering of Alameda County Landscape (1878) Thompson & West. <i>Official and historical atlas map of Alameda County, California (reprint of the 1878 ed. published by Thompson & West, Oakland, Calif.)</i> Fresno, Calif. : Valley Publishers, 1976.	3
1.5	Southern Pacific Train at Seventh & Broadway (1900s) Chris Rhomberg. <i>No There There: Race, Class, and Political Community in Oakland</i> . Berkeley: University of California Press, 2004. 72. Photo courtesy of Bancroft Library, University of California.	4
1.6	Major Construction - Broadway & San Pablo (1906) Oakland History.com < http://www.oaklandhistory.com/files/FNBankConstruction1906.jpg >	4
1.7	Oakland City Hall Construction (1914) < http://www.businessimagegroup.com/images/Oakland-History/CityHall_construction-final_300.jpg >	4
1.8	Downtown Oakland Plan (1878) (modified by author) Thompson & West. <i>Official and historical atlas map of Alameda County, California (reprint of the 1878 ed. published by Thompson & West, Oakland, Calif.)</i> Fresno, Calif. : Valley Publishers, 1976.	4
1.9	Second Oakland Main Library (1902) Oakland Public Library History Website < http://www.oaklandlibrary.org/main50th/mainbldg1913.jpg >	5
1.10	Key System Electric Passenger Streetcar on Broadway Eastbound "A" train crosses Broadway on 12th St. in downtown Oakland. April 15, 1958. John Stashik Collection < http://www.bayarearailfan.org/gallery/v/keyroute/Key118_12_Bway.jpg.html?g2_GALLERYSID=c58273b02c01047534c1cecdfb7fd09a >	5
1.11	Klan Initiation Oakland Auditorium (1924) Chris Rhomberg. <i>No There There: Race, Class, and Political Community in Oakland</i> . Berkeley: University of California Press, 2004. 72. Photo courtesy of Bancroft Library, University of California.	5
1.12	Bay Bridge Construction (1936) The Virtual Museum of the City of San Francisco < http://www.sfmuseum.org/assoc/bridge06.html >	5

1.13	Liberty Ship Launch at Kaiser Shipyards (1942)	6
	Johnson, Marilyn. <i>The Second Gold Rush: Oakland and the East Bay in World War II</i> . Berkeley: University of California Press, 1993. 142. Photo courtesy of Bancroft Library, University of California.	
1.14	Wartime Wealth	6
	Johnson, Marilyn. <i>The Second Gold Rush: Oakland and the East Bay in World War II</i> . Berkeley: University of California Press, 1993. 142. Black Woman Patron at the Richmond Cafe, 1944. Dorthea Lange. Dorthea Lange Collection, Oakland Museum.	
1.15	Downtown Oakland Plan (1950s) (modified by author) Bancroft Library, University of California	6
1.16	General Strike 1946 - Protesters on Broadway	7
	Chris Rhomberg. <i>No There There: Race, Class, and Political Community in Oakland</i> . Berkeley: University of California Press, 2004. 72. Photo courtesy of Bancroft Library, University of California.	
1.17	Business Elite	7
	Chris Rhomberg. <i>No There There: Race, Class, and Political Community in Oakland</i> . Berkeley: University of California Press, 2004. 72. Photo courtesy of Bancroft Library, University of California.	
1.18	Main Oakland Public Library (1951)	7
	Oakland Library History "Construction of the Current Main Library" < http://www.oaklandlibrary.org/main50th/constructlib.html >	
1.19	Freeway Construction (1955)	7
	California Highway and Interstate Historic Photos Construction, 880 (Eastshore Freeway), Market to Tenth St. in Oakland, 5/23/55 < http://www.dot.ca.gov/interstate/images/003.jpg >	
1.20	Black Panther Party 'Free Huey' Protest (1968)	8
	Chris Rhomberg. <i>No There There: Race, Class, and Political Community in Oakland</i> . Berkeley: University of California Press, 2004. 72. Photo courtesy of Oakland Museum of California, Oakland Tribune Collection.	
1.21	Downtown Oakland Plan (1985) (modified by author) Bancroft Library, University of California	8
1.23	Renovated Victorians in Old Oakland	9
	Wikipedia: Old Oakland (c) David Corby (User:Miskatonic, uploader) 2006 < http://en.wikipedia.org/wiki/Image:Oldoakland02262006.JPG >	
1.25	Oakland Population Growth (graph by author)	10
	data from website "Historical Census Populations of Places, Towns, and Cities in California, 1850-2000" (State of California) < http://www.dof.ca.gov/HTML/DEMOGRAP/ReportsPapers/CensusSurveys/Census-Historical/HISTTEXT.HTM >	
1.26	Oakland vs. California Populations (graph by author)	10
	data from Bay Area Census website, prepared by the Metropolitan Transportation Commission and the Association of Bay Area Governments using Census 2000 data. < http://www.bayareacensus.ca.gov/historical/historical.htm >	
1.27	Art and Soul Festival – Downtown Oakland (2006)	10
	< http://www.swansonsound.com/images/art_soul/large/Zulu_Spear_l4.jpg >	

2 PUBLIC LIBRARY

2.1	Library Stacks Kevin Kelly. "What Will Happen to Books?" <i>New York Times Magazine</i> May 14, 2006	13
2.2	Boston Public Library < http://www.designlaboratory.com/courses/96.2/studios/a584.s96.matthews/library/history.html >	14
2.3	Woodcut from Jonathan Swift's 'Battle of the Books' Wikipedia. Image:Swift-Battle.jpg < http://en.wikipedia.org/wiki/Image:Swift-Battle.jpg >	14
2.4	Library photo by Candida Höffer (2002) Höfer, Candida. <i>Candida Hofer : Libraries. Munich : Schirmer/Mosel, 2005. 73.</i>	15
2.5	London Coffeeshouse 1700s < http://www.chass.utoronto.ca/~sajamato/ch5.JPG > from From Pim Reinders, Thera Wijsenbeek et al. <i>Koffie in Nederland: Viereeuwen cultuurgeschiedenis</i> . Zutphen: Walberg Pers; Delft: Gemeente Musea Delft, 1994. 58.	17
2.6	Busy Urban Public Space Anastasia Alexov 2004-2006. "NYC - Central Park -a very busy Walman Rink" < http://spider.ipac.caltech.edu/staff/aalexov/Xmas_NYC_Dec2004/Xmas_NYC_Dec2004-Pages/Image13.html >	19
2.7	"What Makes a Great Place" Project for Public Space < http://www.pps.org/info/placemakingtools/downloads/place_diagrams >	19
2.8	Reading < http://origin-www.britishcouncil.org/jp/global-common-330x220-snapshots-4-00222-women-reading-british-council-library-new-delhi.jpg >	21
2.9	Storytelling < http://www.britishcouncil.org/storytelling.jpg >	21
2.10	Music / Video performance JUDGES\JURIES\EXECUTIONERS < http://www.jjex.com/peopleforaudio003.jpg >	21
2.11	Spoken Word performance artspacegallery.org < http://www.cvco.org/arts/artspace/gallery/gilpin_004lg.jpg >	21

IMAGE CREDITS

3 PROPOSAL : OAKLAND MEDIA LIBRARY

3.0	Downtown Oakland Aerial Photo LCB Associates < http://www.lcbassociates.com/images/aerial.jpg >	26
3.1	Downtown Oakland Points of Reference and Neighbourhoods Aerial Photo (modified by author) from Google Earth < http://earth.google.com/ >	26
3.3	Downtown Oakland Cultural / Educational / Arts Venues Aerial Photo (modified by author) from Google Earth < http://earth.google.com/ >	28
3.4	Bay Area Rapid Transit (BART) System Map BART Maps & Directions < http://www.bart.gov/stations/map/systemMap.asp >	29
3.5	Downtown Oakland Transportation Aerial Photo (modified by author) from Google Earth < http://earth.google.com/ >	29
3.6	Downtown Oakland Open Space and Recreation Aerial Photo (modified by author) from Google Earth < http://earth.google.com/ >	30
3.7	Lafayette Park - 'Block Park' Hood Design, "Lafayette Square Park" < http://www.wjhooddesign.com/lafayette.html >	31
3.12	Surrounding Urban Context Aerial Photo (modified by author) from Google Earth < http://earth.google.com/ >	32
3.14	Site Photo B - from 12th and Broadway 'Street View' from Google Earth < http://earth.google.com/ >	33
3.22a	Roof Terrace in downtown San Francisco SOMA Sun Terrace < http://sanfrancisco.about.com/od/sanfranciscophoto1/ig/sfsoma/somasunterrace.htm >	37
3.24b	Vancouver Public Library Entry Mall Wikipedia.org Image:Vancouver Public Library (interior).jpg < http://en.wikipedia.org/wiki/Image:Vancouver_Public_Library_%28interior%29.jpg >	39
3.24c	Idea Store, Whitechapel, London (modified by author) Bullivant, Lucy. "Idea Stores – David Adjaye." <i>Domus</i> . No 886 (November 2005), 44-51.	39
3.32	Precedents Sendai Mediateque, sendai-shi, miyagi, 1995-2001 detail, courtesy electa < http://www.designboom.com/eng/interview/ito.html > Ellsworth Kelly, Sculpture for a Large Wall, 1957 < http://www.artseensoho.com/Art/MARKS/kelly98/kelly5.html >	46
3.46	Oakland Average Temperatures (graph by author) data from Weather.com MONTHLY AVERAGES for Oakland, CA < http://www.weather.com/outlook/travel/businesstraveler/wxclimatology/monthly/graph/USCA0791?from=36hr_bottomnav_business >	54

BIBLIOGRAPHY

BOOKS

- Avila, Eric. **Popular Culture in the Age of White Flight: Fear and Fantasy in Suburban Los Angeles**. Berkeley: University of California Press, 2004.
- Bagwell, Beth. **Oakland, The Story of a City**. Novato, California: Presidio Press, 1982.
- Balmond, Cecil, and Jannuzzi Smith. **Informal**. Munich: Prestel, 2002.
- Battles, Matthew. **Library: An Unquiet History**. New York: W.W. Norton & Company, 2003.
- Bieri, Susanne and Walther Fuchs. **Bibliotheken Bauen : Tradition und Vision = Building for Books : Traditions and Visions**. Boston: Birkhäuser, 2001.
- Birkerts, Swen. **The Gutenberg Elegies: The Fate of Reading in an Electronic Age**. Boston: Faber and Faber, 1994.
- Black, Alistair. **A New History of the English Public Library: Social and Intellectual Contexts, 1850-1914**. London: Leicester University Press, 1996.
- Borges, Luis. "The Library of Babel." **Labyrinths : Selected Stories & Other Writings**. Translated by James E. Irby. New York : New Directions Pub. Corp., 1964. <http://jubal.westnet.com/hyperdiscordia/library_of_babel.html> accessed 07-06-18
- Buckland, Michael Keeble. **Redesigning library services : a manifesto**. Chicago : American Library Association, 1992. <<http://sunsite.berkeley.edu/Literature/Library/Redesigning/html.html>> accessed 07-06-02
- Buschman, John E., and Gloria J. Leckie eds. **The Library As Place: History, Community, and Culture**. London: Libraries Unlimited, 2007.
- Chideya, Farai. **The Color of our Future**. New York: William Morrow, 1999.
- Chudacoff, Howard and Judith Smith. **The Evolution of American Urban Society**. 5th ed. Upper Saddle River, N.J. : Prentice Hall, 2000.
- Dahl, Svend. **Historia del Libro**. Spain: Alianza, 2000.
- Delaney, Samuel R. "...Three, Two, One, Contact: Times Square Red, 1998." **Giving Ground: The Politics of Propinquity**. London: Verso, 1999.
- Eley, Geoff. "Nations, Publics, and Political Cultures". **Culture / Power / History: A Reader in Contemporary Social Theory**. Princeton, NJ: Princeton University Press, 1994.
- Eymann, Marcia and Charles Wollenberg (Eds). **What's Going On? California and the Vietnam Era**. Oakland: Oakland Museum of California and University of California Press, 2004.
- Farai, Chiyeda. **The Color of Our Future: Race in the 21st Century**. New York: William Morrow and Company, 1999.
- Ferrell, Jeff. **Tearing Down The Streets: Adventures in Urban Anarchy**. New York: Palgrave, 2001.
- Garreau, Joel. **Edge City: Life on the New Frontier**. New York: Doubleday, 1991.
- Habermas, Jurgen. **Structural Transformation of the Public Sphere: A Category of Bourgeois Society**. Translated by Thomas Berger. Cambridge, Mass: MIT Press, 1989. Originally published as *Strukturwandel der Öffentlichkeit* in 1962.
- Höfer, Candida. **Candida Hofer : Libraries**. Munich : Schirmer/Mosel, 2005.
- Hood, Walter. **Urban Diaries**. Washington, DC : Spacemaker Press, 1997.
- Jacobs, Jane. **Cities and the Wealth of Nations: Principles of Economic Life**. New York: Random House, 1984.
- Jacobs, Jane. **The Life and Death of Great American Cities**. New York: Random House, 1961.

- Johnson, George. *In The Palaces Of Memory: How we Build the Worlds Inside Our Heads*. New York, Knopf: 1991.
- Johnson, Marilyn. *The Second Gold Rush: Oakland and the East Bay in World War II*. Berkeley: University of California Press, 1993.
- Kundera, Milan. *Slowness: A Novel*. New York: HarperCollins, 1996.
- Lees, Loretta (Ed.). *The Emancipatory City? Paradoxes and Possibilities*. London: Sage Publications Ltd, 2004.
- Lefebvre, Henri. "The Production of Space". *Rethinking Architecture*. Leach, Neil (editor). London: Routledge, 1997. 139-147.
- Levine, Lawrence. *Highbrow / Lowbrow: The Emergence of Cultural Hierarchy in America*. Cambridge, Massachusetts: Harvard University Press, 1988.
- Levine, Lawrence. *The Opening of the American Mind: Canons, Culture, and History*. Boston: Beacon Press, 1996.
- Low, Setha, Dana Taplin and Suzanne Scheld. *Rethinking Urban Parks: Public Space and Cultural Diversity*. Austin, Texas: University of Texas Press, 2005.
- Mitchell, William J. *City of Bits: Space, Place and the Infobahn*. Cambridge, MA: MIT Press, 1996.
- Molz, Redmond Kathleen and Phyllis Dain. *Civic Space/Cyberspace: The American Public Library in the Information Age*. Cambridge, Massachusetts: MIT Press, 1999.
- Pease, Allan and Barbara. *The Definitive Book of Body Language*. New York: Bantam Books, 2004.
- Reed, Ishmael. *Blues City: A Walk in Oakland*. New York: Crown Journeys, 2003. p 24
- Reed, Ishmael (ed.) *MultiAmerica : Essays on Cultural Wars and Cultural Peace*. New York: Viking, 1997.
- Reisner, Marc. *A Dangerous Place: California's Unsettling Fate*. New York: Pantheon Books: 2003
- Rhomberg, Chris. *No There There: Race, Class, and Political Community in Oakland*. Berkeley: University of California Press, 2004.
- Scott, Mel. *The San Francisco Bay Area: A Metropolis in Perspective*. 2nd Ed. Berkeley: University of California Press, 1985.
- Self, Robert O. *American Babylon : Race and the Struggle for Postwar Oakland*. Princeton, N.J. : Princeton University Press, 2003.
- Shenk, David. *Data Smog: Surviving the Information Glut*. New York: Harper Collins, 1997.
- Sorkin, Micheal, and Jean Copjec, eds. *Giving Ground: The Politics of Propinquity*. London: Verso, 1999.
- Starr, Kevin. *Coast of Dreams: California on the Edge, 1990-2003*. New York: Alfred A. Knopf, 2004.
- Urban, Roger F. *Oakland: a Mediterranean City*. Publishing Location & Publisher Unknown, 1976. p48
- Van Slyck, Abigail Ayres. *Free to All: Carnegie Libraries and the Transformation of American Culture, 1886-1917*. Doctor of Philosophy Dissertation, University of California, Berkeley, 1989.
- Virilio, Paul. *The Information Bomb*. Translated by Chris Turner. London: Verso, 1998.
- Watkins, Craig. *Hip Hop Matters: Politics, Pop Culture, and the struggle for the soul of a movement*. Boston : Beacon Press, 2005.

Watson, Sophie. *City publics : the (dis)enchantments of urban encounters*. London: Routledge, 2006.

Whyte, William. *The Social Life of Small Urban Spaces*. New York: Project for Public Spaces, 1980.

JOURNAL ARTICLES

Akst, Daniel. "Do Libraries Still Matter?" *Carnegie Reporter*. Vol 3, No 2 (Spring 2005), <<http://www.carnegie.org/reporter/10/books/index3.html>> (accessed July 29, 2006), 3.

Bullivant, Lucy. "Idea Stores – David Adjaye." *Domus*. No 886 (November 2005), 44-51. (Idea Store Whitechapel)

Carroll, Michael. "Literary Layers." *Canadian Architect*. Vol 51, No 3 (March 2006), 32-37. (La Grande Bibliothèque du Quebec)

Crawford, Margaret. "Contesting the Public Realm: Struggles over Public Space in Los Angeles." *Journal of Architectural Education*. Vol 49, No. 1 (September 1995), 4-9.

Fraser, Nancy. "Rethinking the Public Sphere: A Contribution to the Critique of Actually Existing Democracy." *Social Text*. No 25/26 (1990), 56-80.

Harmanci, Reyhan. "Oakland's Emerging Arts Scene." *San Francisco Chronicle*, May 27, 2007.

"Idea Store In London" *Detail*. n.10, v.44 (October 2004) 1120-1123 (Idea Store Chrisp)

McCrossen, Alexis. "'One Cathedral More' or 'Mere Lounging Places for Bummers'?" The Cultural Politics of Leisure and the Public Library in Gilded Age America." *Libraries & Culture* 41.2 (2006), 169-188.

Popowich, A.S. "The Politics of Public Library History." *Dalhousie Journal of Information & Management*. Vol 3, No 1 (Winter 2007), <http://djim.management.dal.ca/issues/issue3_1/popowich/index.htm> (accessed June17, 2007).

Stuhldreher, Anne. "Against Gentrification: Marcel Diallo sees a black cultural district where Oakland's the Bottoms neighborhood now stands" *San Francisco Chronicle*, Sunday, January 21, 2007. <<http://sfgate.com/cgi-bin/article.cgi?file=/c/a/2007/01/21/CMG93N6V7B1.DTL>> accessed 07-03-15

Yokomizo, Makoto, and Toyo Ito, "Winning Project of the Sendai Médiathèque Design Competition." *Japan Architect*. No 19 (Autumn 2005), 92-99.

WEBSITES

American Library Association website, <<http://www.ala.org>> (accessed 2006-07-28)

City of Oakland Office of Parks and Recreation website, <<http://www.oaklandnet.com/parks/>> (accessed 2007-07-24)

COMMONspace website, <<http://www.rebargroup.org/projects/commonspace/>> (accessed 2007-08-30)

Google Earth map images, <<http://earth.google.com/>> (accessed 2006-08-23)

Hood Design website, <<http://www.wjhooddesign.com/home.html>> (accessed 2007-08-01)

Idea Store website, Tower Hamlets Borough Council, <<http://www.ideastore.co.uk/>> (accessed 2006-10-10)

International Federation of Library Associations and Institutions, "IFLA/UNESCO Public Library Manifesto 1994," <<http://www.ifla.org/VII/s8/unesco/eng.htm>> (accessed 2006-08-23)

MondoMap, "Jack London: Oakland Convention & Visitors Bureau District Maps," <<http://>>

mondomap.com/mondo/map_ocvb.cfm?bid=10> (accessed 2007-06-04)

MTC-ABAG Library, "Bay Area Census – Historical Data," <<http://www.bayareacensus.ca.gov/historical/historical.htm>> (accessed 2007-07-15)

Oakland Art Murmur, "map – oakland.art.murmur," <<http://www.oaklandartmurmur.com/pages/Jmap/Jmap.php>> (accessed 2007-08-10)

Oakland Community and Economic Development Agency, "Oakland CEDA - 10K Housing Initiative," <<http://www.business2oakland.com/main/10kdowntownhousinginitiative.htm>> (accessed 2007-08-15)

Oakland Convention and Visitors Bureau website, <<http://oaklandcvb.com/>> (accessed 2007-07-04)

Oakland History Center website, <<http://www.oaklandhistory.com/>> (accessed 2006-06-12)

Oakland Public Library website, <<http://www.oaklandlibrary.org/>> (accessed 2006-05-18)

Project for Public Spaces website, <<http://www.pps.org/>> (accessed 2007-02-08)

Storycorps website, Sound Portraits Productions, <<http://www.storycorps.net>> (accessed 2007-08-15)

The Organic City website, <<http://www.theorganiccity.com>> (accessed 2007-08-20)