

**The Fabrication Commons:**  
Creative Agency Through Intuitive Interfaces

by  
Alexander Gontarz

A thesis presented to  
the University of Waterloo  
in fulfilment of the  
thesis requirement for the degree of  
Master of Architecture

Waterloo, Ontario, Canada, 2020  
© Alexander Gontarz 2020

## **Author's Declaration**

I hereby declare that I am the sole author of this thesis.  
This is a true copy of the thesis, including any required  
final revisions, as accepted by my examiners.

I understand that my thesis may be made electronically  
available to the public.



## Abstract

With digital fabrication tools and networking technology becoming increasingly attainable and versatile, there is an opportunity for more people to become makers instead of just being passive consumers. How can we take advantage of this to foster larger local and global communities of makers? Most digital fabrication research focuses on a singular novel process or application of a tool, and not the actual relationship between the users and the entire fabrication process. To engage a broader audience with digital fabrication, I propose a user-centric ecosystem that attempts to seamlessly link all of the individual elements of the workflow. My research involves designing a series of prototypes for inexperienced makers that lower the barriers of complex workflows. By doing this, anyone can be empowered to shape their environment and cater to their needs and desires without relying on mass-produced goods. With more engaging, accessible methods of fabrication, people can benefit from the advantages of creating something themselves, and form communities that are more empowered and meaningfully connected.



## Acknowledgments

I would like to express thanks to my advisor,  
Jonathan Enns, for his guidance and enthusiasm.

Thank you to my committee David Correa for his  
insights and advice

Thank you to Maya Przybylski for giving me  
clarity in the early months.



# Table of Contents

<b>x</b>	<b>List of Figures</b>
<b>1</b>	<b>Introduction</b>
<b>3</b>	<b>Chapter 1: The importance of making</b>
<b>14</b>	<b>Chapter 2: A framework for a ecosystem for making</b>
<b>24</b>	<b>Chapter 3: Prototypes</b>
26	Prototype 1: Collaborative Creation
32	Prototype 2: Custom Materials
38	Prototype 3: Open Construction Kit
44	Prototype 4: Smart Material Library
52	Prototype 5: Tactile Designer
60	Prototype 6: Robotic Coworking
<b>68</b>	<b>Chapter 4: Discussion</b>
<b>78</b>	<b>References</b>
<b>82</b>	<b>Appendix : Prototype Resources</b>
<b>88</b>	<b>Appendix: Other Projects</b>
<b>94</b>	<b>Glossary</b>





## List of Figures

### CHAPTER 1

- 1 fig 1-1: Prototype 6, detail of human-robot interaction (by author)
- 2 fig 1-2: Woodcut of traditional potter. (source: Publius Vergilius Maro, Augsburg, 1544)
- 2 fig 1-3: Digital clay printer (by author)
- 4 fig 1-4: The four industrial revolutions (by author)
- 6 fig 1-5: Centralized vs distributed manufacturing (by author)
- 8 fig 1-6: Ikea ThisAbles project (source: IKEA, thisables.com)
- 8 fig 1-7: Modular boxes for Extinction Rebellion (source: Extinction Rebellion, rebellion.earth)
- 10 fig 1-8: The Shop – Analog tool DIY space in Toronto (source: theshoptoronto.ca)
- 10 fig 1-9: New York Hall of Science MakerSpace (source: nycsci.org)
- 12 fig 1-10: Mimus - Project by Atonaton (source: atonaton.com)
- 12 fig 1-11: The Hive Pavilion (source: autodeskresearch.com)

### CHAPTER 2

- 16 fig 2-1: Users (source: brocku.ca)
- 17 fig 2-2: Space (source: John Tierney, theatlantic.com)
- 18 fig 2-3: Materials (source: architectmagazine.com)
- 19 fig 2-4: Physical Tools (source: makezine.com)

- 20 fig 2-5: Design Tools (by author)  
21 fig 2-6: Systems (source: Toniture , weburbanist.com)  
22 fig 2-7: Knowledge (by author)  
23 fig 2-8: Interface (source: Fox, Michael, and Miles Kemp. Interactive Architecture)

### **CHAPTER 3**

- 24 fig 3-1: Prototypes overview (by author)  
26 fig 3-2: Prototype 1 overview diagram (by author)  
28 fig 3-3: Prototype 1 video (by author)  
30 fig 3-4: Prototype 1 system diagram (by author)  
31 fig 3-5: Prototype 1 future version (by author)  
32 fig 3-6: Prototype 2 overview diagram (by author)  
34 fig 3-7: Prototype 2 process (by author)  
35 fig 3-8: Prototype 2 finished product (by author)  
36 fig 3-9: Prototype 2 detail (by author)  
36 fig 3-10: Prototype 2 future version (by author)  
38 fig 3-11: Prototype 3 overview diagram (by author)  
40 fig 3-12: Prototype 3 module details (by author)  
41 fig 3-13: Prototype 3 possible assemblages (by author)

- 42 fig 3-14: Prototype 3 possible community contributions (by author)
- 42 fig 3-15: Thingiverse, a popular model sharing platform (source: [thingiverse.com](http://thingiverse.com))
- 44 fig 3-16: Prototype 4 overview diagram (by author)
- 46 fig 3-17: Prototype 4 video (by author)
- 48 fig 3-18: Prototype 4 system diagram (by author)
- 50 fig 3-19: Prototype 4 detail (by author)
- 50 fig 3-20: Prototype 4 future version (by author)
- 52 fig 3-21: Prototype 5 overview diagram (by author)
- 54 fig 3-22: Prototype 5 video (by author)
- 56 fig 3-23: Prototype 5 system diagram (by author)
- 58 fig 3-24: Prototype 5 detail (by author)
- 58 fig 3-25: Prototype 5 future version (by author)
- 60 fig 3-26: Prototype 6 overview diagrams (by author)
- 62 fig 3-27: Prototype 6 video (by author)
- 64 fig 3-28: Prototype 6 system diagram (by author)
- 66 fig 3-29: Prototype 6 detail (by author)
- 66 fig 3-30: Prototype 6 future version (by author)

## **CHAPTER 4**

- 68 fig 4-1: Vignette 1: the Fabrication Commons (by author)
- 70 fig 4-2: Vignette 2: the Hacked Home (by author)
- 72 fig 4-3: Community interaction #1 (by author)
- 73 fig 4-4: Community interaction #2 (by author)
- 74 fig 4-5: Community interaction #3 (by author)
- 75 fig 4-6: Community interactions combined (by author)
- 77 fig 4-7: All prototypes (by author)

## **APPENDIX**

- 88 fig A-1: 3d printed robot reacting to body position (by author)
- 89 fig A-2: Proposed extra levels of Human-Robot Collaboration (by author)
- 90 fig A-3: Reimagining traditional craft (by author)
- 91 fig A-4: Scale and robotic trust (by author)
- 92 fig A-5: UR Robot following finger motion in 3d space (by author)
- 92 fig A-6: Projection calculating area of boxes (by author)
- 93 fig A-7: Drawing complex cutting patterns on plywood with projected guides (by author)

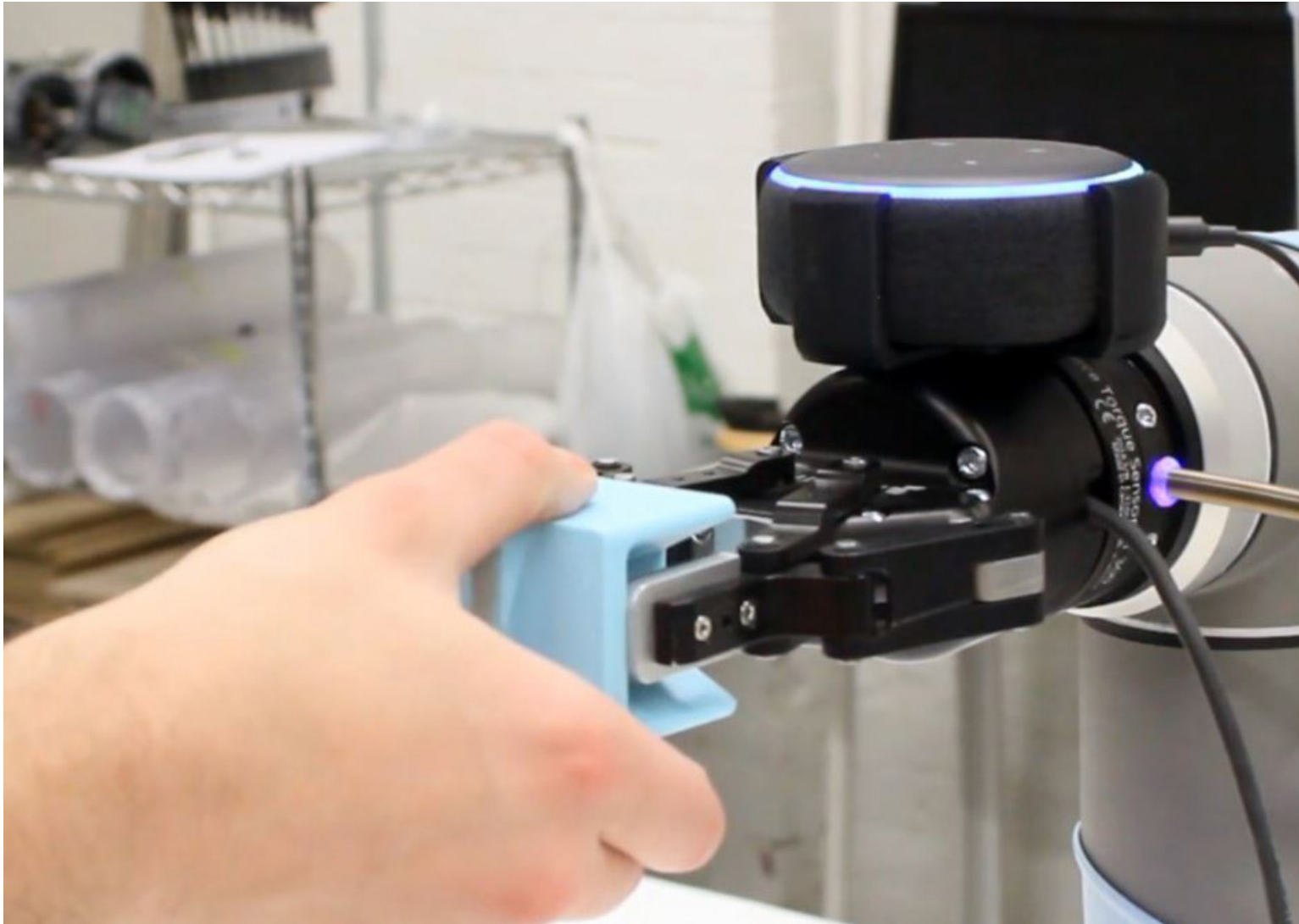

*fig 1-1: Prototype 6, detail of human-robot interaction*

## **Introduction**

For as long as I can remember, the act of making things has been incredibly important to me. The process of taking an initial idea and developing it into a final product was not only extremely gratifying, but educational in a way that didn't feel imposed. It felt like materializing exactly what I wanted from thin air through my force of will. I wondered why everyone else around me wasn't constantly creating new things. I often got the same answer: "Why would I spend all of this effort, when I can just buy it cheaper?". Modern urban dwellers prefer to be consumers of mass produced physical goods, leaving the messy production hidden out of sight. This might explain the frustrations I felt while making - when I didn't have the right space, or the right tools, or someone to teach me how to do something. With production and consumption so separated, making seems to be much less culturally important these days. This takes away resources and opportunities to engage people that might benefit as I did from making something themselves. I believe that modern fabrication and networking can bring back craft to mainstream culture, and that as a designer, I can create interfaces and tools and contribute to engaging non-experts with making to bring about this cultural shift.



fig 1-2: Woodcut of traditional potter (source: Publius Vergilius Maro, Augsburg, 1544)



fig 1-3: Digital clay printer (source: by author)



## CHAPTER 1: The importance of making

Physically creating something is an important part of the human experience. Before the era of large manufacturing industries, people created many of the things that surrounded them for themselves, their families, or, if they happened to be specialized craftspeople, their local communities. People were both producers and consumers operating at a very local scale. They were also working together towards a common goal, exchanging information, developing skills, creating social connections, and creating a unique character for the community. These benefits still apply today. Studies show that physically creating something can be beneficial not only to interpersonal relationships, but personal mental and physical well-being. (Collier and Wayment, 2017)

In his book, "The Alphabet and the Algorithm", Mario Carpo clearly outlines how much modern digital fabrication has in common with pre-industrial craft:

*"As advanced cad-cam systems already support and, indeed, encourage cooperation and interaction among human actors and technical networks in all stages of design and production, the end result of full, digitally supported notationality in architecture may also reenact some of the original, ancestral, and autographic aspects of artisanal hand-making."*

-Mario Carpo, 2011 (The Alphabet and the Algorithm, pg 92)

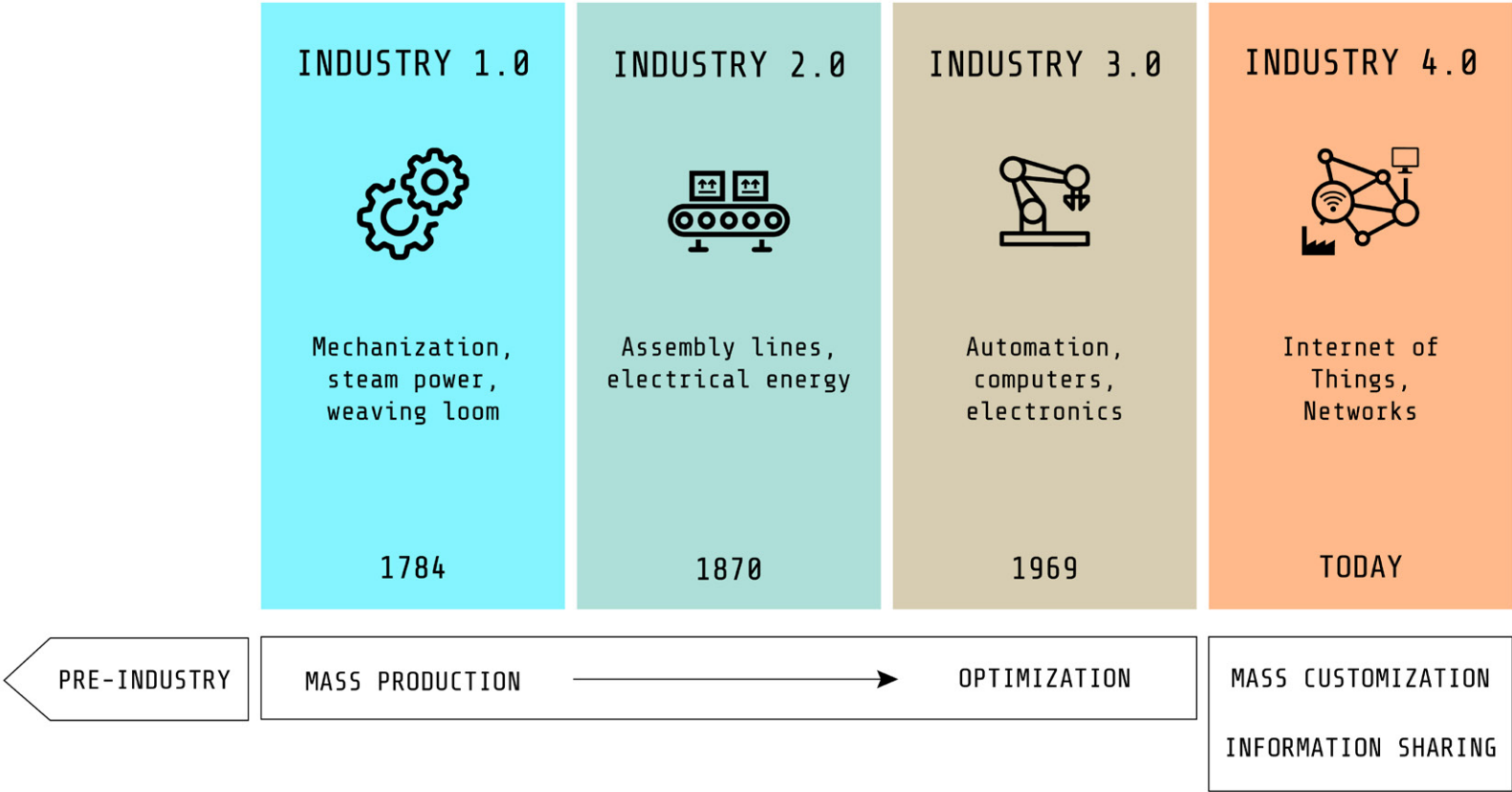

fig 1-4: The four industrial revolutions (source: by author)

## **Modern Mass-Produced Manufacturing**

Today's economic model, along with technology and globalization, streamlines the production of goods into complex, vertically integrated manufacturing chains. This brings large volumes of inexpensive products to consumers, but at the cost of choice and variety (Alptekinoglu and Corbett, 2008). People are also less involved and less aware about how the products they consume come into existence, making it harder to appreciate its value. With manufacturing facilities moving away from urban centres, urban dwellers have little choice but to be nothing more than consumers (Gornig and Goebel, 2016).

The economic model of modern capitalism inevitably creates an imbalanced power dynamic between the producer and consumer. Since profit is usually the driving factor of any decisions of a large business, the attitude towards the consumer can be of indifference or even outright oppression. This becomes more apparent as the market share of a company increases towards a total monopoly. One of the ways that the consumer is brushed aside is the lack of choice and variety. A one-size-fits-all model necessarily caters to a majority, and often ignores a wide variety of differences in ability, culture, religion, even personal preference. The first industrial revolution brought unprecedented output but also homogenization and sameness. Made-to-order, bespoke fabrication became less and less economically feasible as these vertical manufacturing processes grew.

The newest step in the evolution of industry is being called Industry 4.0 (Lasi et al.). The first three are optimizations to the idea of mass production and vertically integrating systems, but Industry 4.0

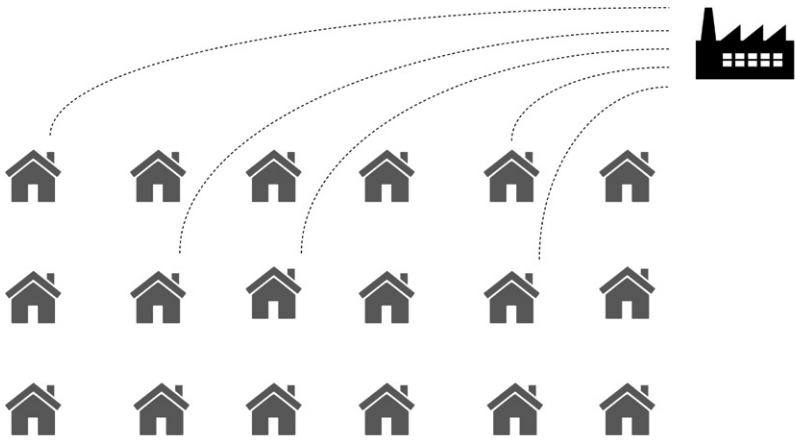

**CENTRALIZED**



**DISTRIBUTED**

*fig 1-5: Centralized vs distributed manufacturing (source: by author)*

provides a distinct disruption in the form of both mass customization using digital fabrication tools, and an unprecedented exchange of information. Both of these qualities lend itself to the possibility of successfully decentralizing fabrication. The impact of economy of scale is becoming smaller and smaller. A democratic mode of making as described in the following quote, finally seems feasible.

*"Today we are immersed in forces and ideas that hinder the fulfillment of human purposes; large corporations standardize and limit our choice; philosophies of behaviorism condition people to deny their potential freedom; "modern architecture" becomes the convention for "good taste" and an excuse to deny the plurality of actual needs. But a new mode of direct action is emerging, the rebirth of a democratic mode and style, where everyone can create his personal environment out of impersonal subsystems, whether they are new or old, modern or antique. By realizing his immediate needs, by combining ad hoc parts, the individual creates, sustains and transcends himself. Shaping the local environment towards desired ends is a key to mental health; the present environment, blank and unresponsive, is a key to idiocy and brainwashing."*

- Charles Jencks 1972, (Adhocism, pg 15)

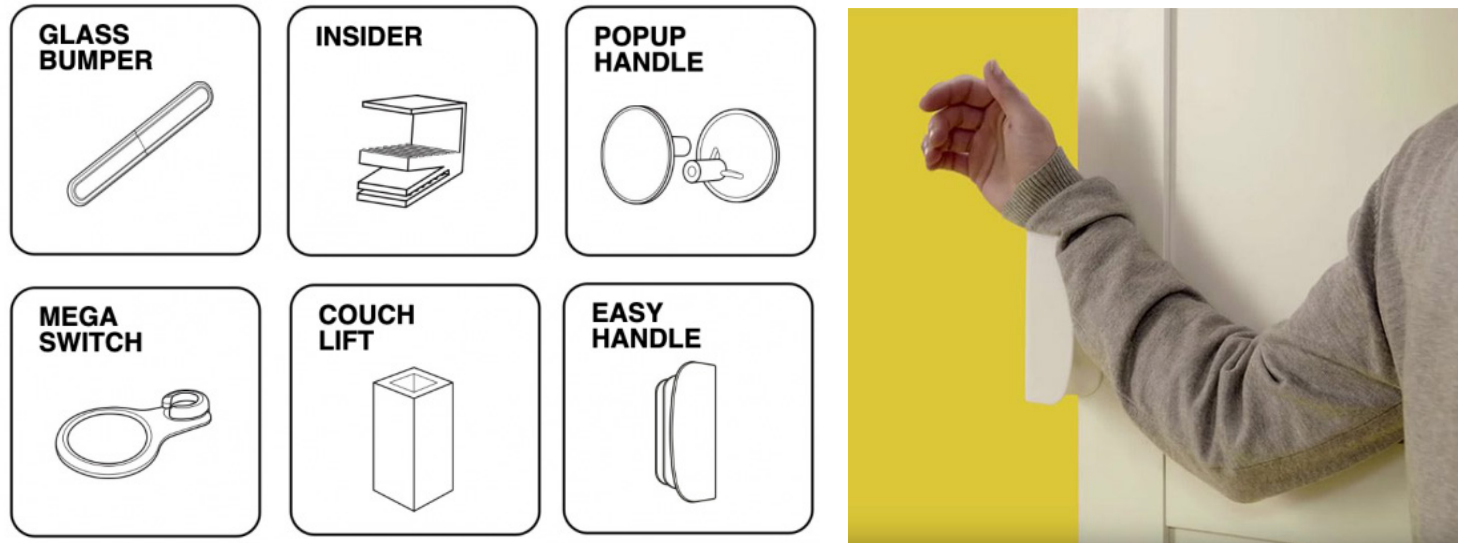

fig 1-6: Ikea ThisAbles project (source: IKEA, thisables.com)



fig 1-7: Modular boxes for Extinction Rebellion (source: Extinction Rebellion, rebellion.earth)

## **Empowerment through Local Digital Fabrication**

How does a world look like where this “plurality of actual needs” is realized? Many digital fabrication projects give us an insight into what happens when an individual or a community is empowered to make whatever they need, whenever they need it. The following are examples where empowering people to create with digital fabrication tools has a positive impact.

The IKEA ThisAbles project (fig 1-6) ([thisables.com](http://thisables.com)) is a series of hacks that will make some standard IKEA furniture more accessible for people with special needs. The designs are free to download and print for anyone. Some of these designs include a larger handle that allows for opening with a forearm, and a bumper that protects glass furniture from collision. Mass producing these would not be feasible for adapting to every users needs.

Studio Bark shared their designs with the protest group Extinction Rebellion (fig 1-7), a modular box that can be fabricated with a CNC machine (Jessel, 2019). During a protest, the boxes can be easily assembled into structures to occupy a space, becoming difficult to dismantle. This is a great example of sharing designs and empowering a group in a way that would be difficult otherwise, because the anti-institutional implications of the design would make traditional manufacturing companies reluctant to create and sell a product such as this.



fig 1-8: The Shop – Analog tool DIY space in Toronto (source: theshoptoronto.ca)



fig 1-9: New York Hall of Science MakerSpace (source: nycsci.org)



## **Maker Culture**

In urban environments, the informational act of design and physical act of production are largely separated. However, many people are trying to bring about spaces where both can happen in the form of makerspaces, hackerspaces, or fabrication labs. One of the earliest examples of a makerspace is the MIT Fab Lab, established in 2001 by Neil Gershenfeld. He saw the potential of small-scale digital fabrication, and the importance of being involved in both the informational and physical aspects of creation. He believed that these skills and resources should be available to anyone: from artists, students, engineers, to small businesses (Gershenfeld 2007). In recent years, the growth of the maker movement and further affordability of tools led to the establishment of these in places such as libraries and community centres, or even dedicated buildings. However, these spaces focus heavily on the education aspect, or expect that the user already has a high proficiency without much guidance.

Two examples of successful makerspaces are The Shop in Toronto (fig 1-8) and NYSCI in New York (fig 1-9). The Shop is an analog DIY space that focuses on ceramics and woodworking. The New York Hall of Science focuses on educating children and engaging them in STEAM activities (science, technology, engineering, arts and mathematics). However, even the most successful spaces suffer from a lack of internal exchange of information, as well as outreach to the surrounding neighbourhood, communicating the value of the space, and adapting to the needs of the community.

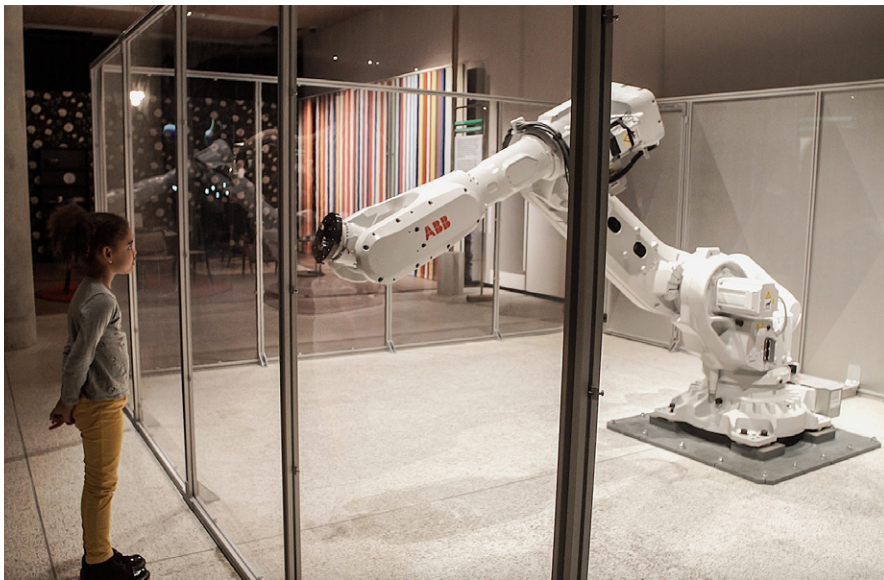

fig 1-10: Mimus - Project by Atonaton (source: atonaton.com)

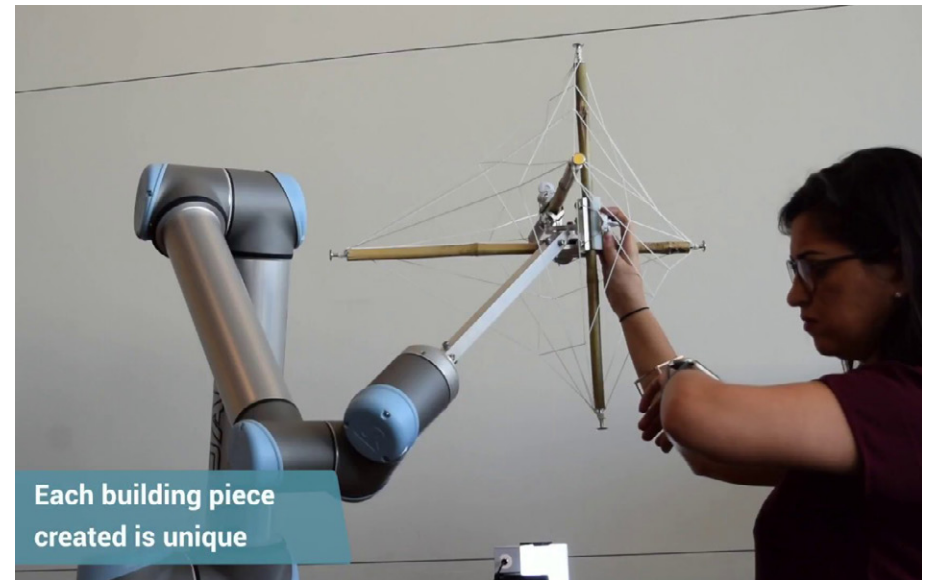

fig 1-11: Hive Pavilion by Autodesk (source: autodeskresearch.com)

## State of the Art

Much digital fabrication research focuses on the complexity of the final product. Some researchers, like the studio Atonaton, studies the relationship between human and machine (fig 1-10). There are few projects that focus on both the interaction between the user and the machine, and the final fabricated product. It is crucial to examine both, because the strength of digital fabrication is adapting to each users' needs, and this can only be done successfully if those needs are communicated adequately. One project that does this well is the Hive pavilion by Autodesk (fig 1-11). This structure is a complex form created by inexperienced users working with collaborative robots towards a common goal. It is important not only to examine how this interaction affects the final product, but to communicate the value of using these machines to prospective new makers.

*"The challenge isn't, at all, to propose the deployment of new fabrication technologies, but to deploy them in modes, configurations and assemblages that might effectively resist capture by existing logics of accumulation and exploitation, and bind them into processes that are generative of lasting and significant shared value. Those interested in seeing digital fabrication used as part of a project of radical transformation will need to invest a great deal of effort into ensuring that the way in which one would go about using it is actively invitational, not merely demystified and formally accessible."*

-Adam Greenfield, 2017 (Radical Technologies, pg 98)

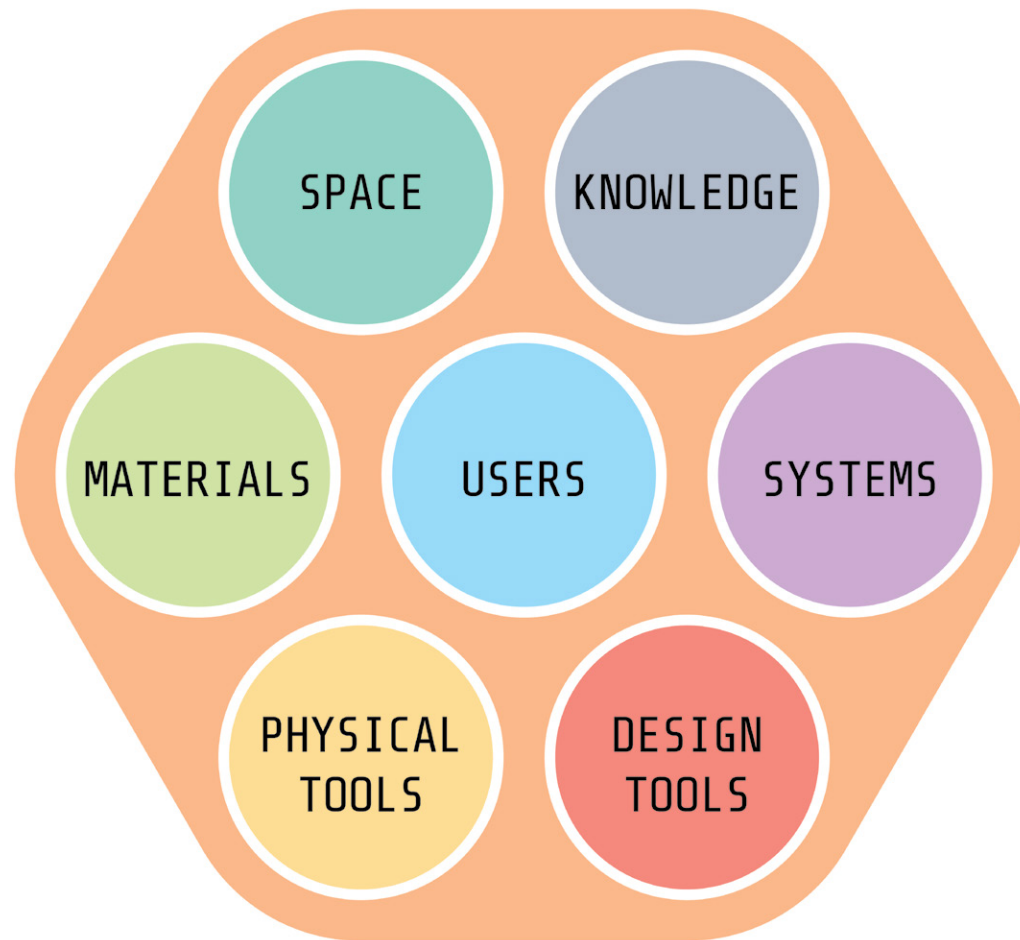

## CHAPTER 2: An Ecosystem for Making

We can foster larger communities of makers by designing an engaging, interconnected, decentralized ecosystem for making. I propose a model that can be used as a guide to successfully deploy these new technologies. They must go beyond being formally available, to being a catalyst for education, innovation and social connection.

This ecosystem, called the *Fabrication Commons* considers the users as central actors, and their relationship to the elements needed for fabrication: space, materials, physical tools, design tools, systems, and knowledge. Finally, the interface layer (in orange) examines the relationship between these elements, and aims to remove any barriers or resistance between them, so that information and resources can flow freely.

The name "*Fabrication Commons*" is taken from a broader ideology of the Collaborative Commons and applies it to local manufacturing. This is essentially the sharing spirit of the maker movement as an alternative economic model:

*The democratization of innovation and creativity on the emerging Collaborative Commons is spawning a new kind of incentive, based less on the expectation of financial reward and more on the desire to advance the social well-being of humanity. And it's succeeding.*

- Jeremy Rifkin, 2014 (The Zero Marginal Cost Society, pg 34)

## USERS

The human actors in the ecosystem. Each one has different desires, skills, knowledge. It is important to facilitate interaction between users and the other elements, but equally important to facilitate user-user interactions.

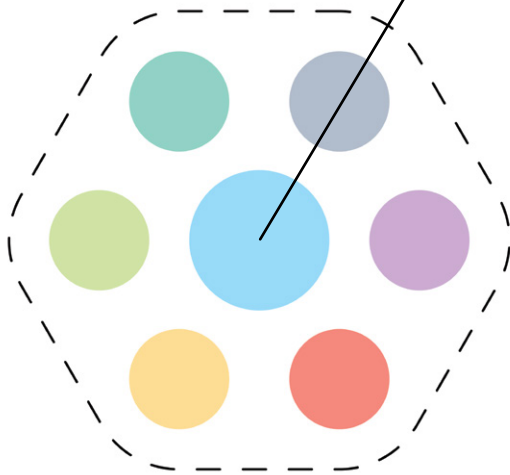

fig 2-1: Users (source: brocku.ca)

## SPACE

The physical space required for learning, designing, making, storing, collaborating, and socializing.

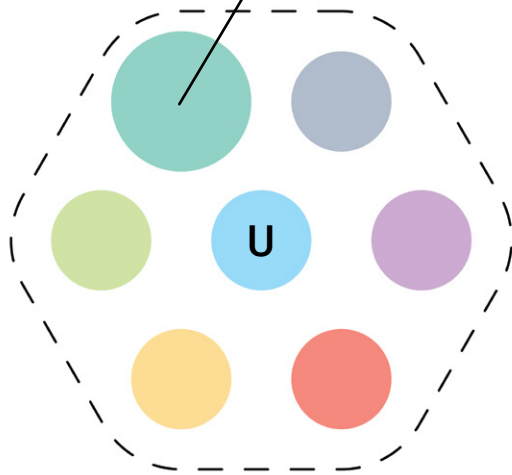

fig 2-2: Space (source: John Tierney, theatlantic.com)

## MATERIALS

The raw matter, parts, components, or assemblies that are consumed to form the end product.

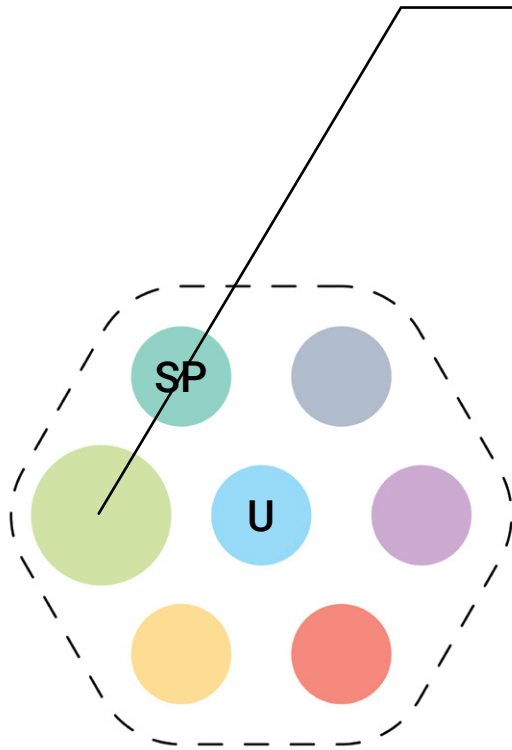

fig 2-3: Materials (source: architectmagazine.com)



## PHYSICAL TOOLS

A device or implement used to carry out a particular function, like modifying a material

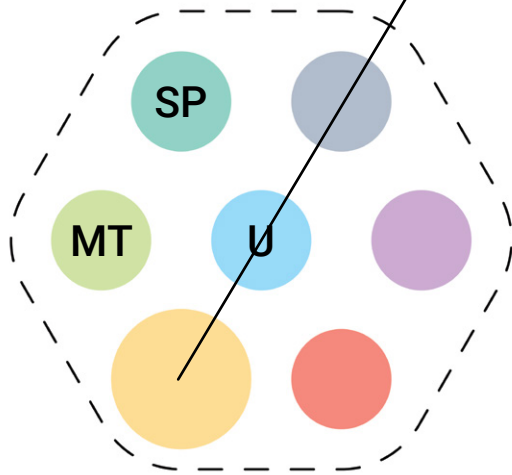

fig 2-4: Physical Tools (source: makezine.com)

## DESIGN TOOLS

Used to plan the qualities, function, and assembly process of a finished product before it is realized – usually a digital tool

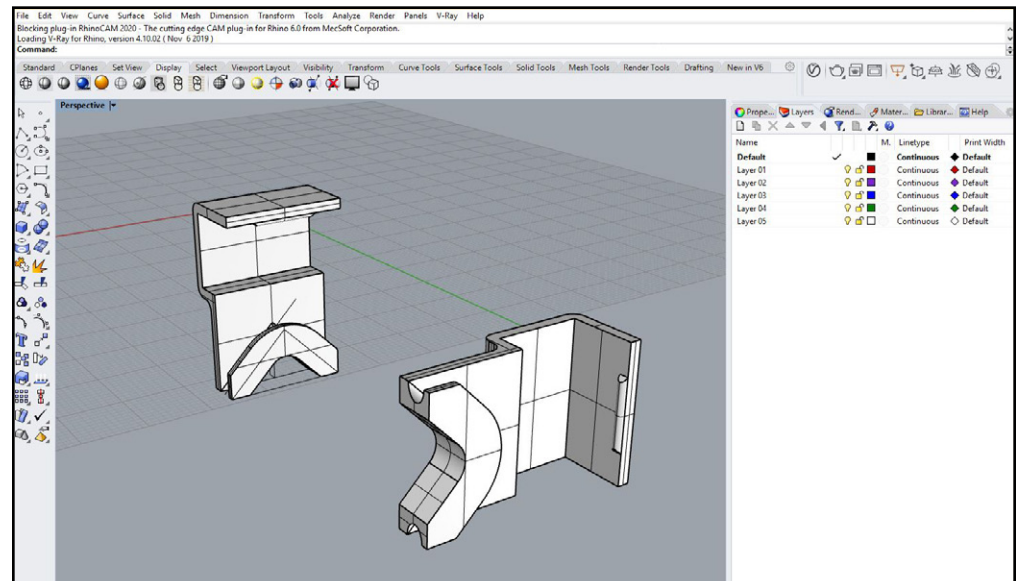
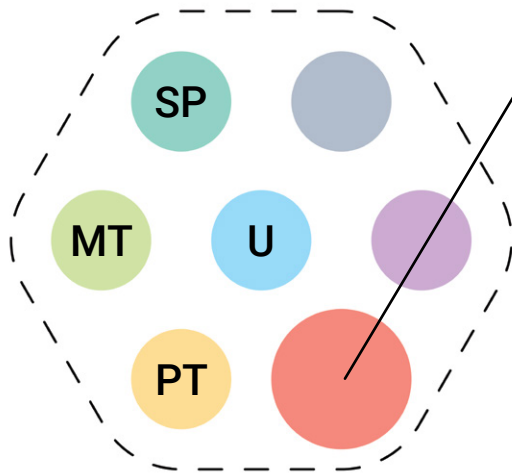

fig 2-5: Digital Tools (source: by author)

## SYSTEMS

Groups of items which are organized in a way that aids users reach their desired goal. These can include: toolkits, modules, design libraries, open-ended parametric designs.

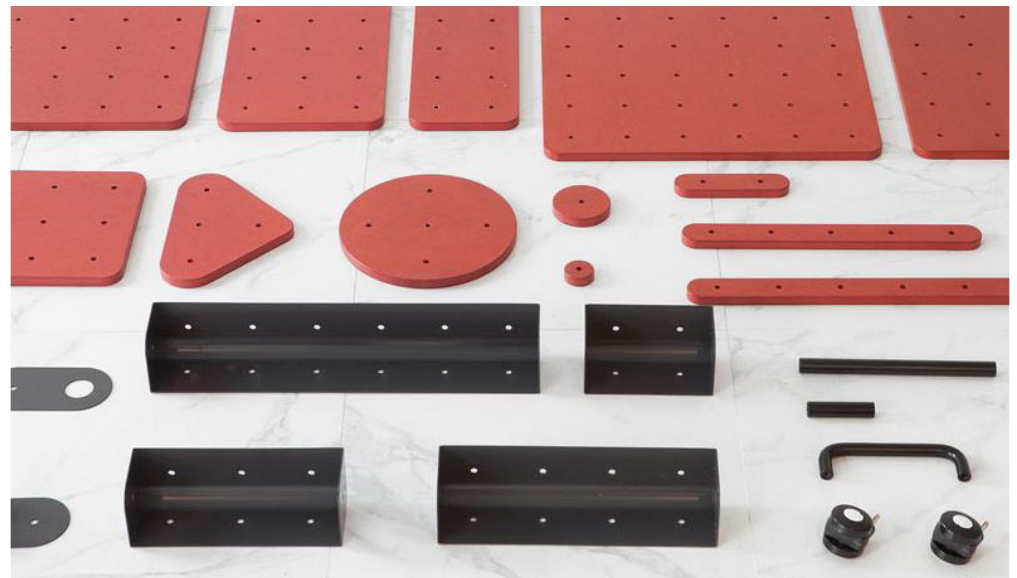
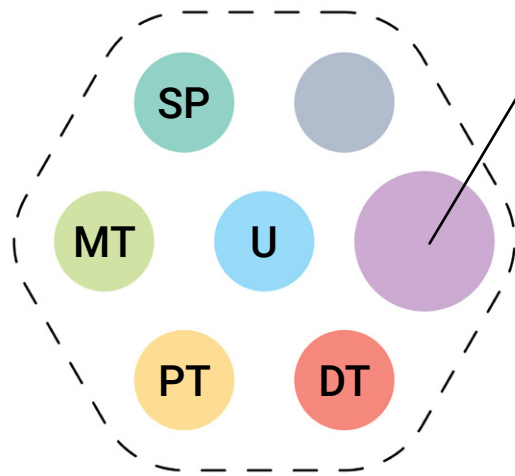

fig 2-6: Systems (source: Toniture , weburbanist.com)

## KNOWLEDGE

Facts, information, skills, an understanding of a subject. Can be passed from person to person, or stored and recalled from books, devices, or networks.

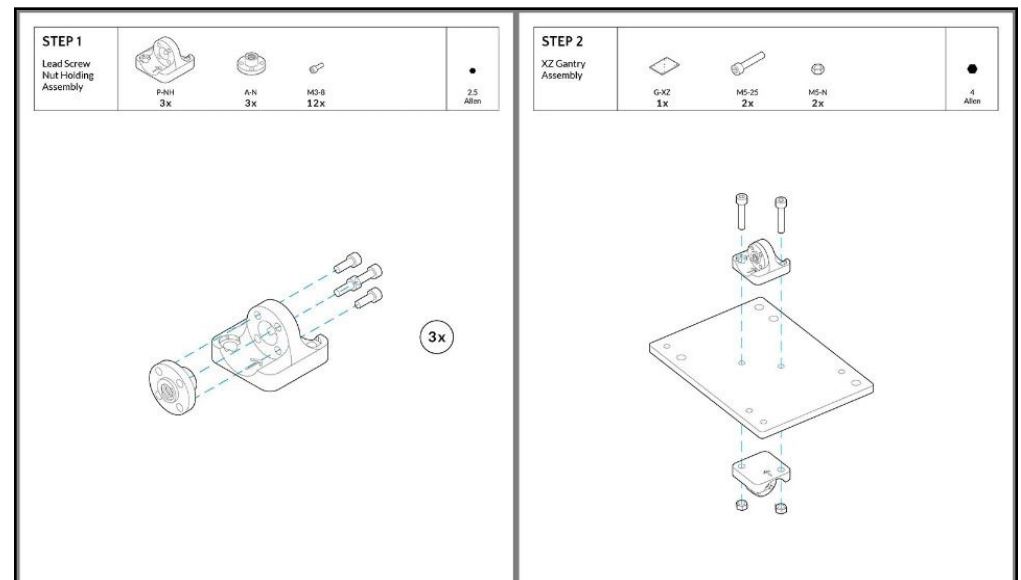
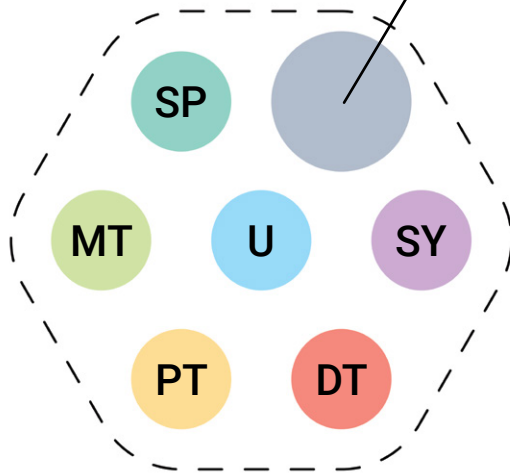

fig 2-7: Knowledge (source: by author)

## INTERFACE

A shared boundary where two distinct parts of a system meet and can exchange information.

The unifier of all previous elements.

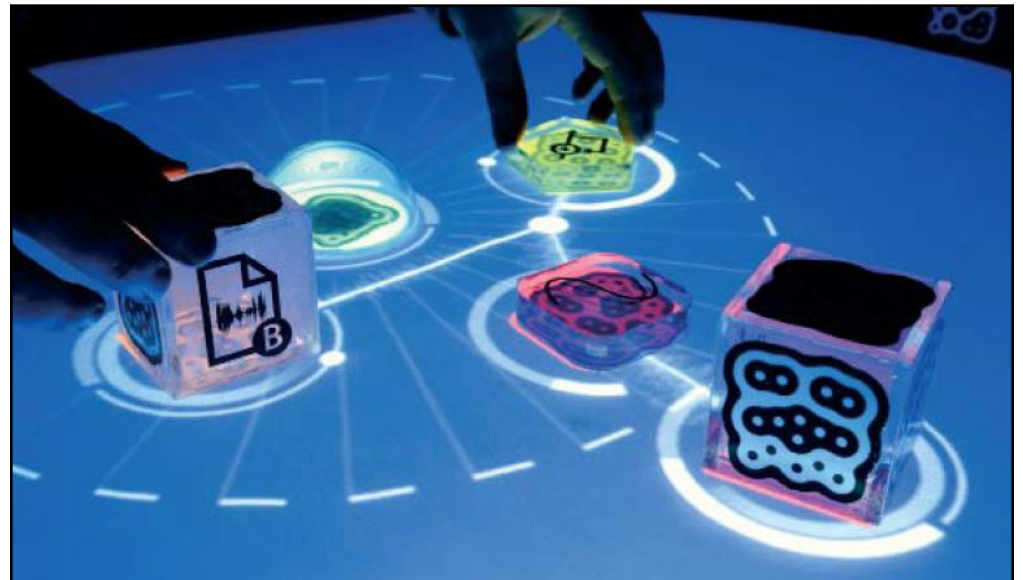
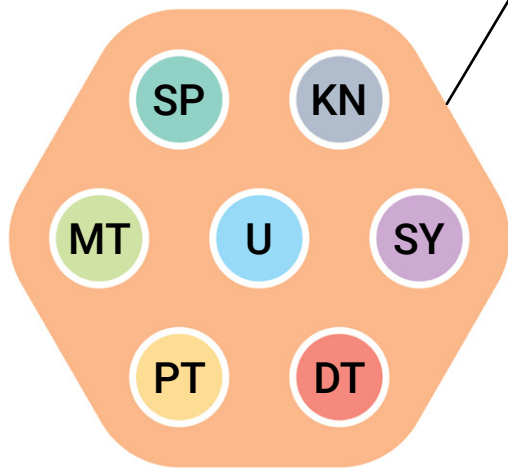

fig 2-8: Interface (source: Fox, Michael, and Miles Kemp. *Interactive Architecture*)

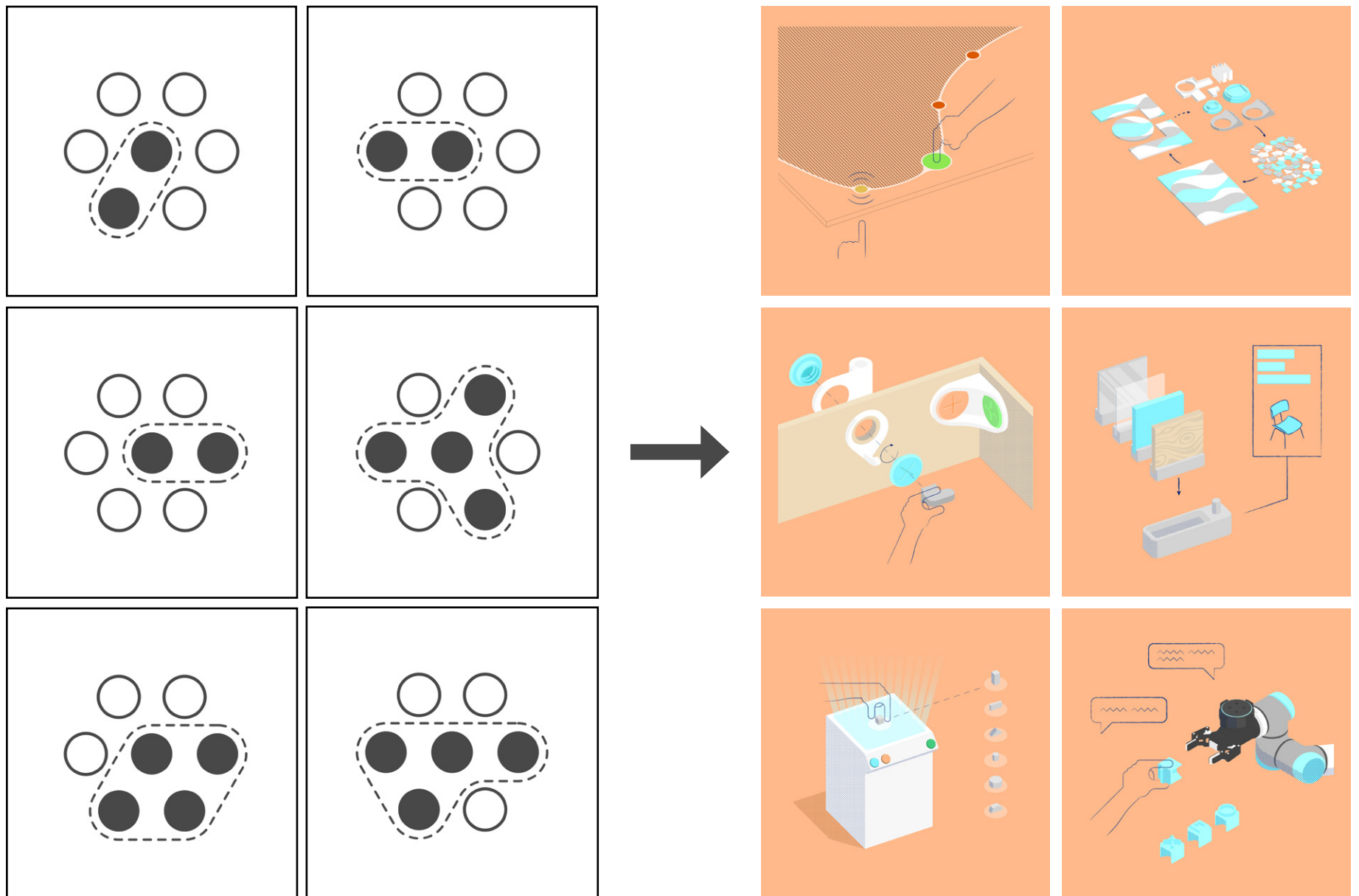

fig 3-1: Prototypes Overview (source: by author)

## Chapter 3: Prototypes

This thesis examines the individual elements of fabrication and analyzes how they are connected – or how they often fail to connect. Six interface tool prototypes are designed to bridge the gaps between the elements themselves, and between the elements and the user. In a community where every individual is empowered to design and fabricate anything they need (shifting from a consumer to a prosumer), the role of the traditional designer can shift to that of a meta-designer. This is someone who facilitates these interactions, and curates the amount and difficulty of content for newer users.

I have selected five criteria for success for these prototypes, shown on the right. The prototype is ranked based on: how engaging it is, how intuitive it is, if it lowers an accessibility barrier of some sort, if it encourages a dialogue between users, and if it has the ability to adapt to user needs.

The title page of each prototype also has a diagram illustrating which elements of the ecosystem are being linked together, and a QR code that leads to a webpage with the resources and instructions required to recreate the prototype. (A regular URL is also provided at the end of each prototype)

**Engagement** ○○○  
**Intuition** ○○○  
**Accessibility** ○○○  
**Dialogue** ○○○  
**Customizability** ○○○

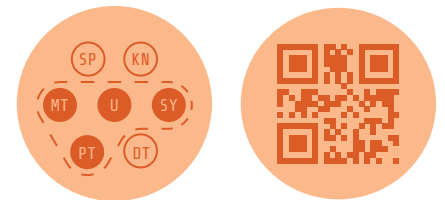

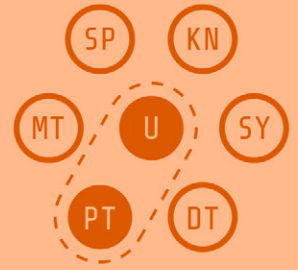
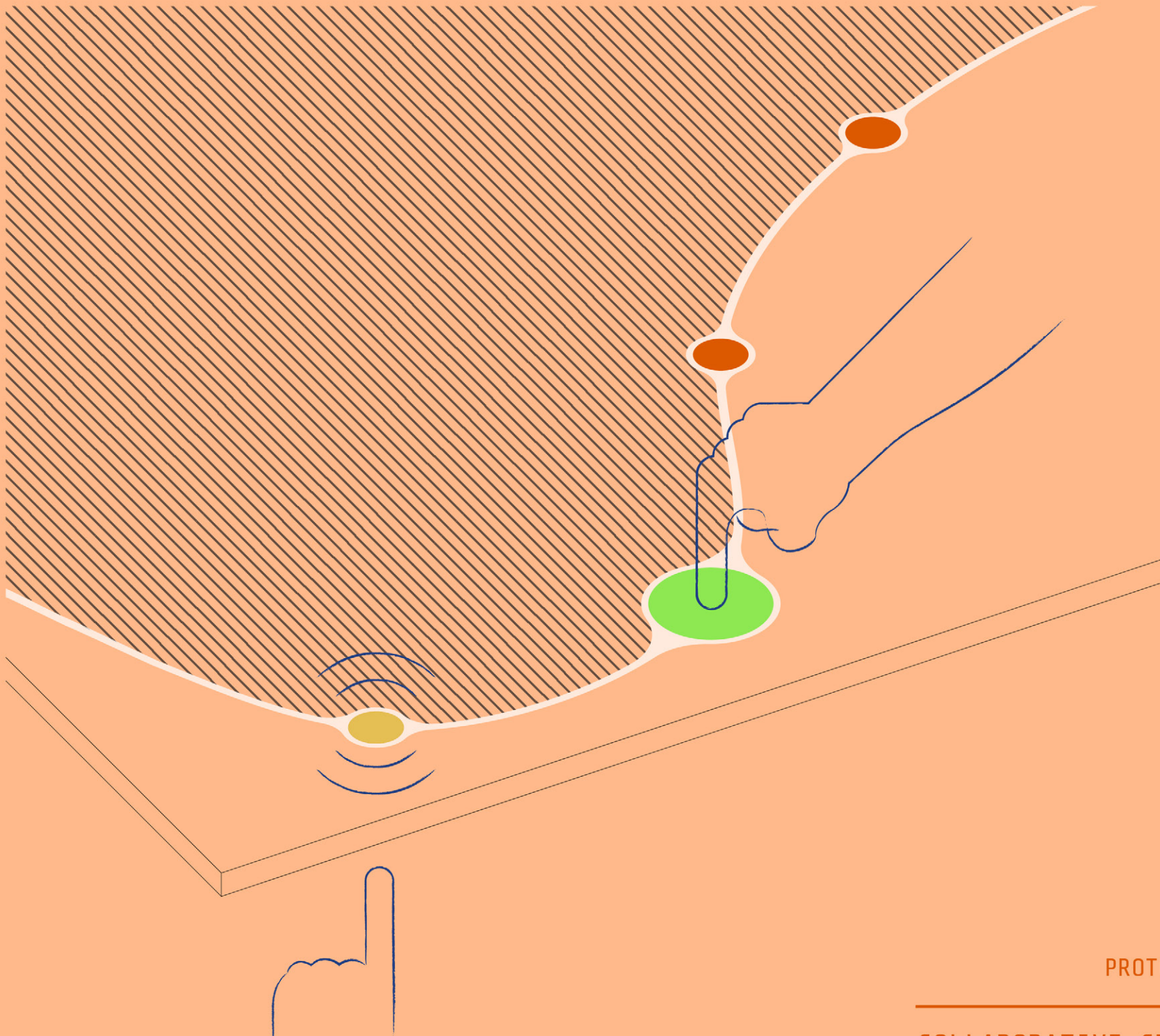

USERS  
+ DESIGN TOOLS

PROTOTYPE-01

COLLABORATIVE CREATION





## **PROTOTYPE 1: Collaborative Creation**

How can we engage multiple people into the digital design process? Most forms of digital design revolve around creating a virtual 2d or 3d representation of the design on a computer monitor using a mouse and keyboard. There is a physical frame of reference that is lost when using such digital peripherals when compared to an analog design process like drawing, molding or cutting. There is also a social, collaborative aspect that digital design makes much more difficult. By making digital design more physical and full-scale again, it can become a more social activity. Where there is an open exchange of ideas, there will be people of all skill levels interested in joining and learning.

The first prototype aims to do this by using a reactive, tactile projection at full scale onto the working material. The outline of the design is projected, along with control points that react to nearby users' fingers, and are activated once contact with the material is made. The interface is limited in what it can achieve, but playful and unintimidating to novices. Unlike a CAD software, no experience is necessary to operate it successfully because of an intuitive understanding of how things are moved physically. It is also a more social democratic mode of design, as there is no one person that is explicitly "in control" of the process at any one time.

*fig 3-2: Prototype 1 overview diagram (source: by author)*

fig 3-3: Prototype 1 video (source: by author)

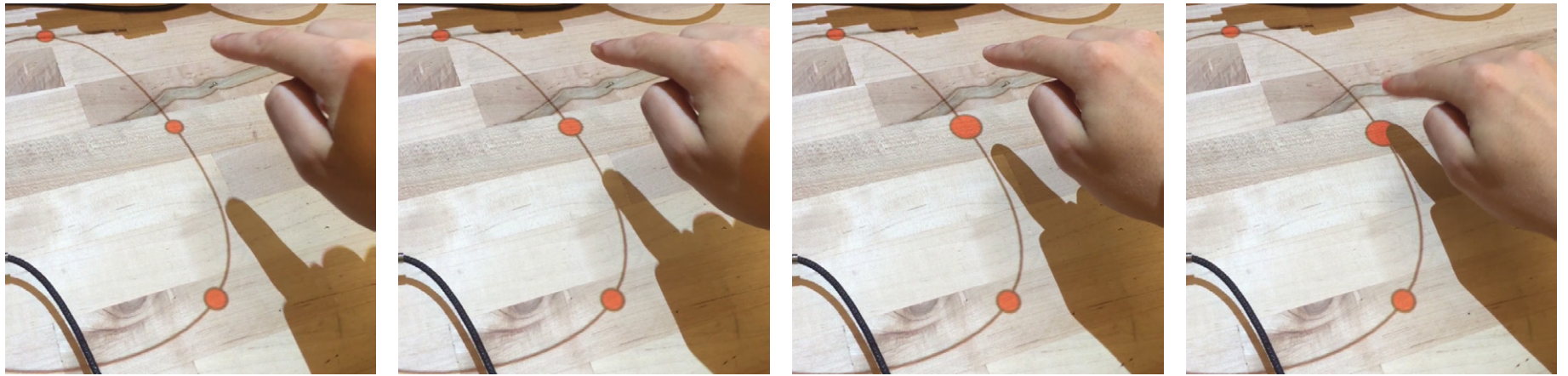

Reacting to distance of finger

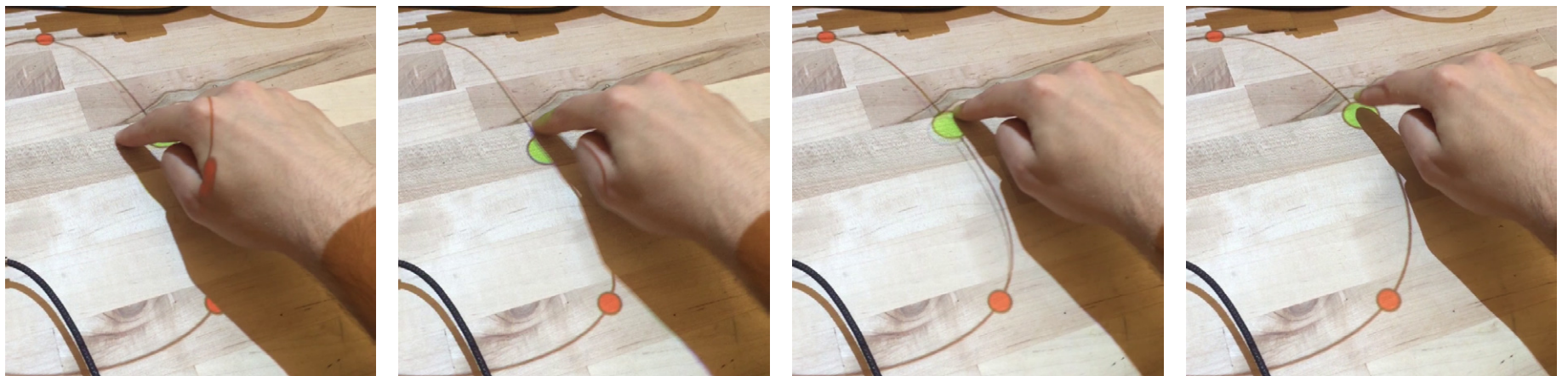

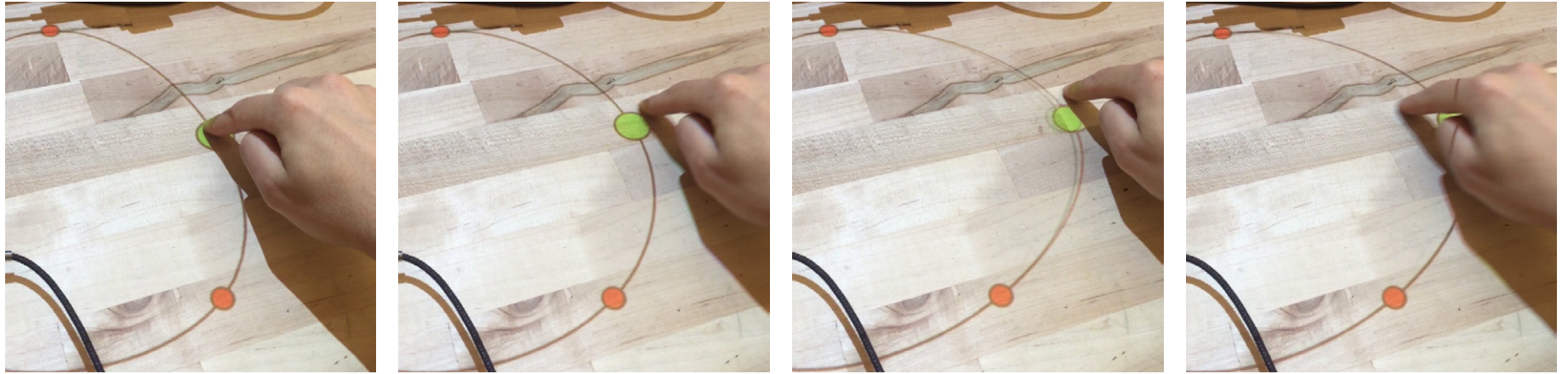

Moving the control point with finger

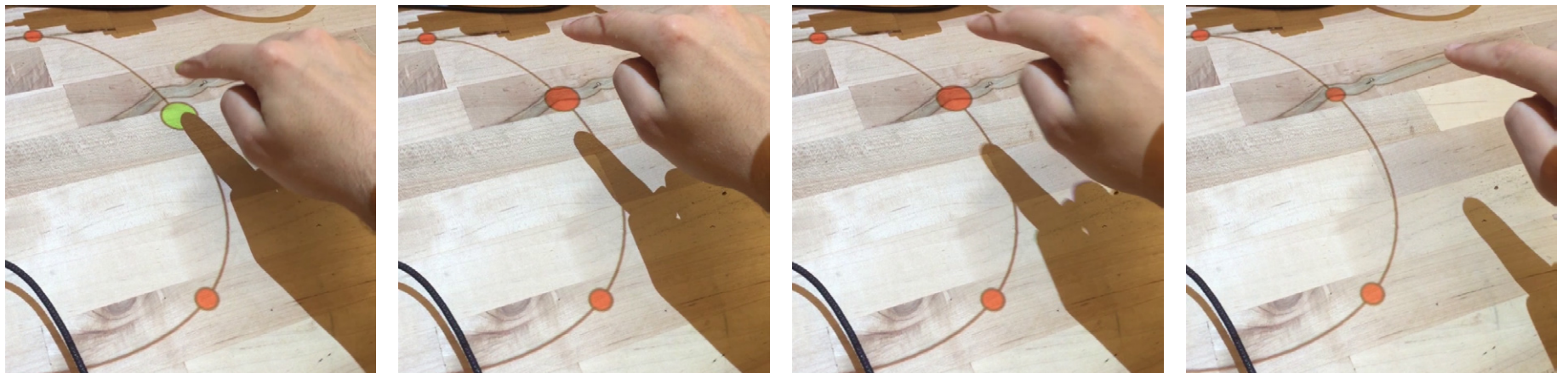

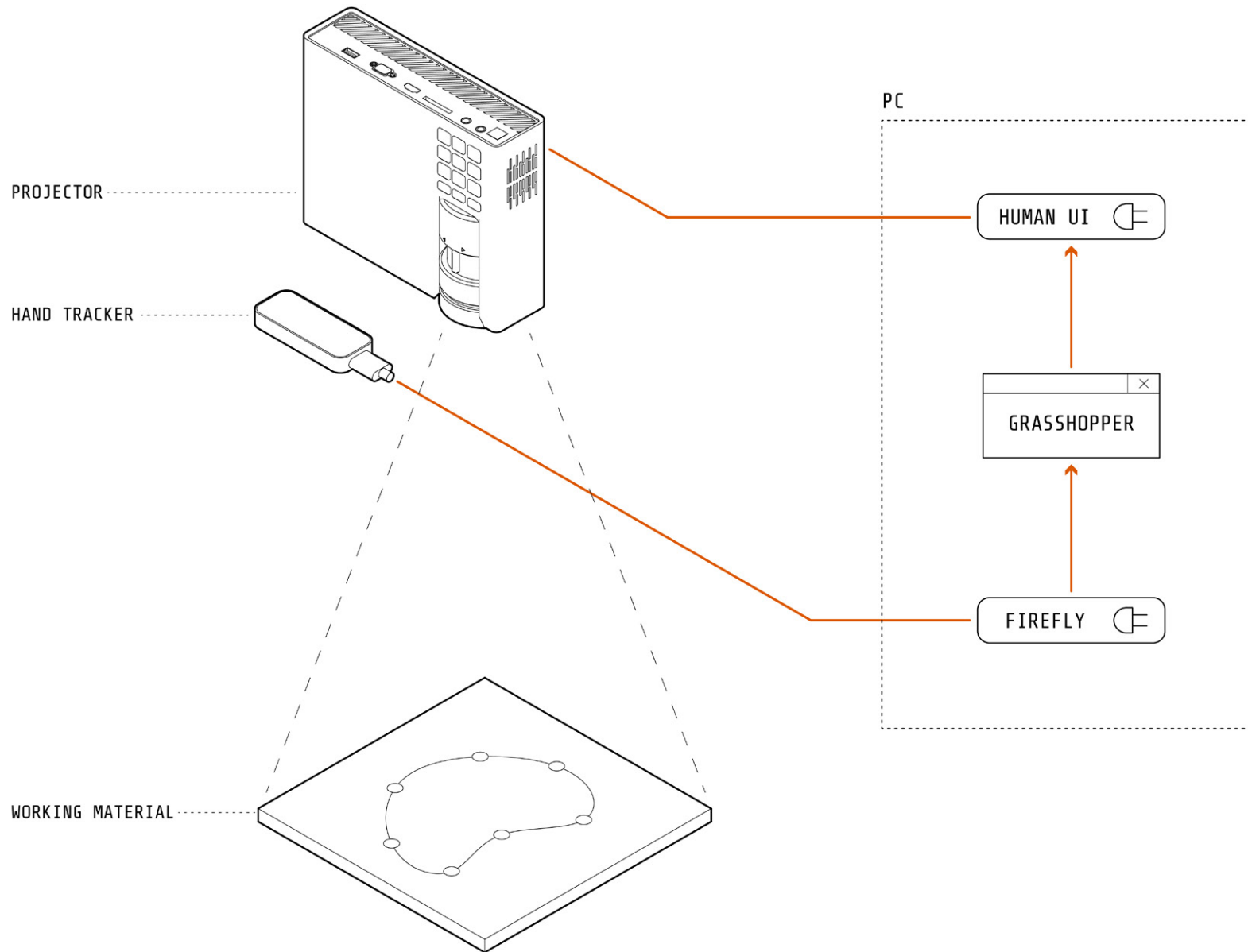

fig 3-4: Prototype 1 system diagram (source: by author)

This is done using a script, projector and hand tracker (fig 3-4). When a hand is recognized, the closest control point expands or shrinks based on the distance to the index finger. When it is below a certain threshold, the control point activates, changes colour, and moves in sync with the finger.

A next step for this prototype would be actually incorporating it into a digital fabrication tool, and adding some restrictions to the design, based on the limitations of the tool. (fig 3-5). By bypassing the obstacles that modern design tools can have, this prototype can hopefully make the design process less intimidating for new users, and make it more of a social activity.

Resources for Prototype 1: <http://agontarz.com/p01/>

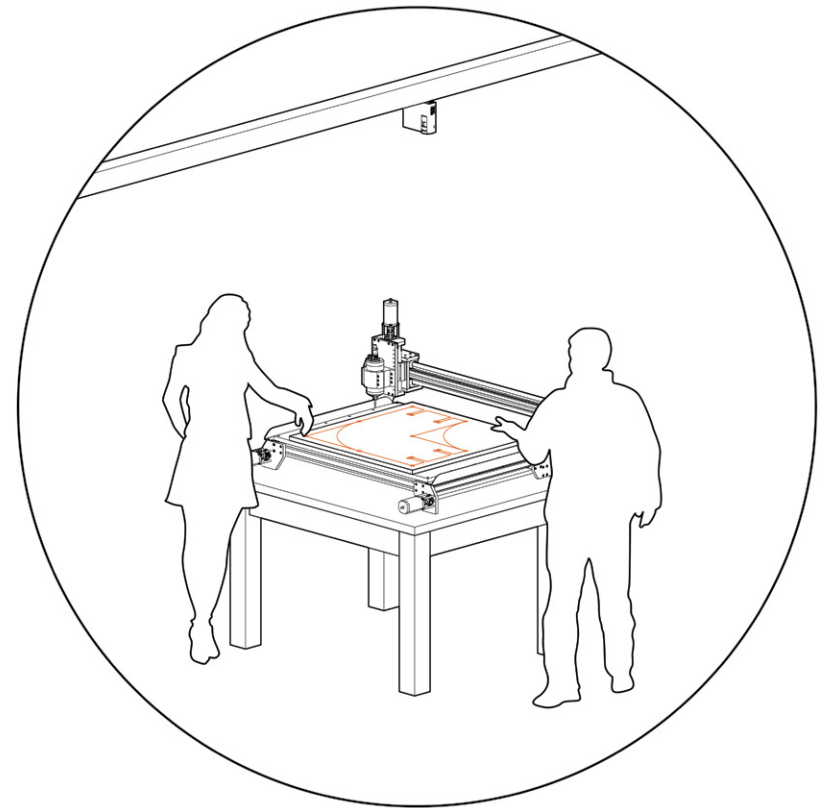
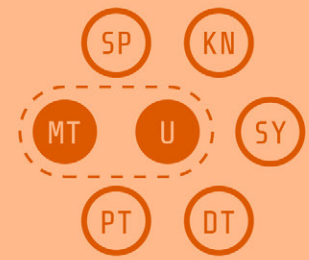
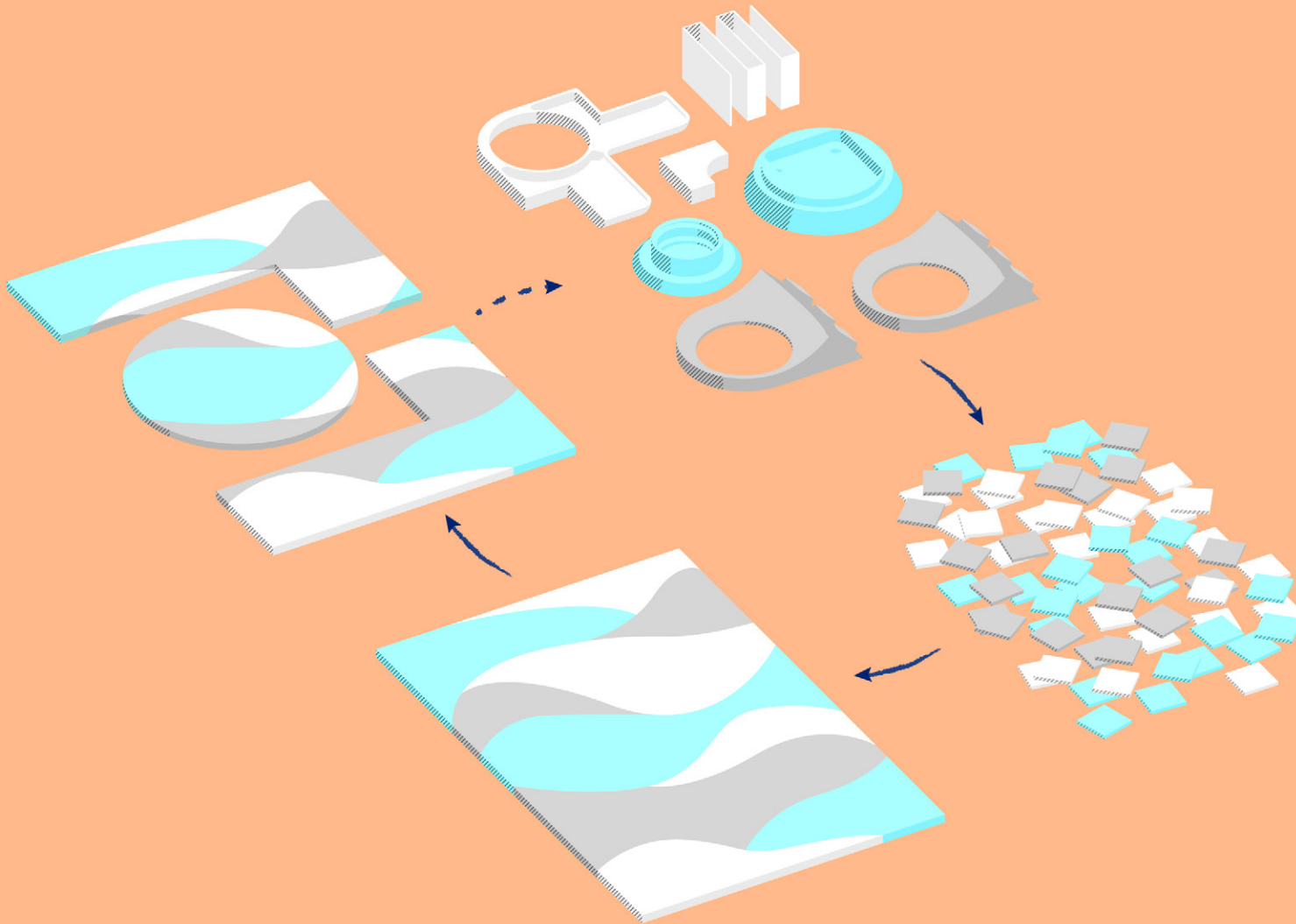

fig 3-5: Prototype 1 future version (source: by author)

- Engagement ●●○
- Intuition ●●●
- Accessibility ●●○
- Dialogue ●●●
- Customizability ●○○



USERS  
+ MATERIALS



PROTOTYPE-02

CUSTOM MATERIALS



## **PROTOTYPE 2: Custom Materials**

How can we involve people in the creation of their own raw materials? An important step in designing something is choosing appropriate materials. There can be much consideration when it comes to choosing a material - aesthetics, price, durability - however, the process that goes into making the raw material itself is sometimes unappreciated, and often inaccessible. If the mass customization of products is possible in Industry 4.0, a small selection of homogeneous materials shouldn't be the limiting factor. Just as important is the environmental factor. By involving the prosumer in the creation of materials locally, material cycles become smaller geographically, and the final product becomes more sustainable.

Inspired by the Precious Plastics project ([preciousplastic.com](http://preciousplastic.com)), Prototype 2 is an attempt to create unique, desirable raw materials from waste by-products of other digital fabrication processes. I collected some of my own 3d printing waste, and some more from the local maker space. Normally, these parts would be discarded and end up in a landfill. However, I turned them into desirable, workable raw material by shredding the parts, combining the colours that I wanted, heating, and finally pressing the heated form.

*fig 3-6: Prototype 2 overview diagram (source: by author)*

fig 3-7: Prototype 2 process (source: by author)

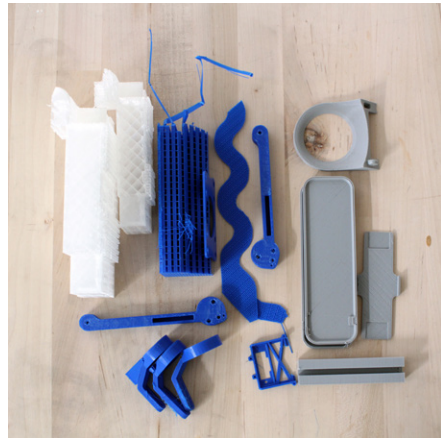

*organizing misprints*



*shredding into chips*



*mixing in tray*



*shredding into chips*



*mixing in tray*



*pressing after heating*





*fig 3-8: Prototype 2 finished product (source: by author)*

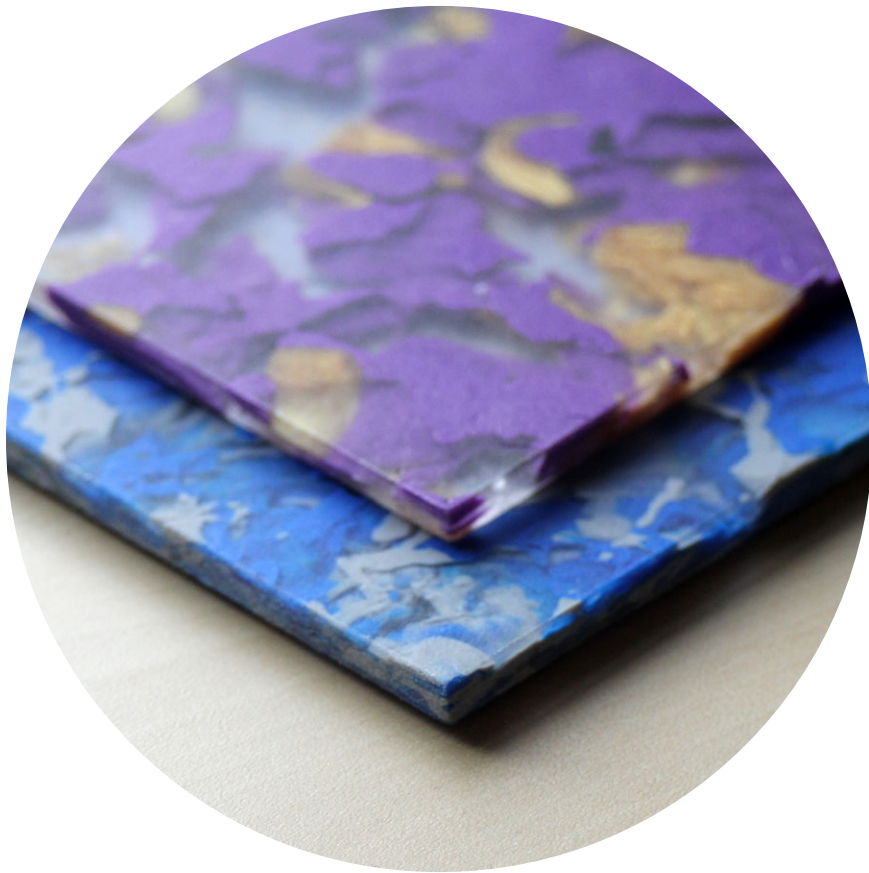

fig 3-9: Prototype 2 detail (source: by author)



fig 3-10: Prototype 2 future version (source: by author)

To get an output I was satisfied with, there was some experimentation with the colour and grain of the shredded plastic, the temperature, the duration of heating, and the pressure of the vice. Adding a clear plastic gave the purple and gold sheet an beautiful depth. Heating the blue sheet for longer and pressing down harder made the plastic creep outward, mixing more towards the edges. (fig 3-9) Now, they can be worked into a new product on a laser cutter or CNC machine. A brand-new life cycle is created for the material, and possibly more if it becomes reworked into something new again.

A future version of this experiment (fig 3-10) would be fine tuning this process of changing all of the variables to make the output reliable and consistent. And of course, incorporating a large heated press. Much like the Precious Plastics project is aiming to do, this process would be supported by a community of people with excess waste and a feeling of responsibility to the environment. Even if these community members are not makers, the prospect of creating something new and unique from their junk may be incentive enough to do so. This prototype adds a new layer of customizability, and gives users a better appreciation of material life cycles.

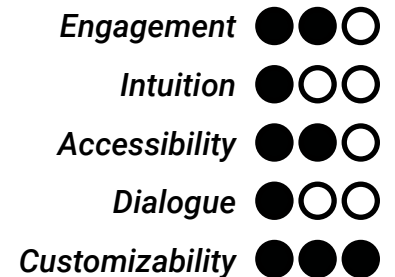

*Resources for Prototype 2: <http://agontarz.com/p02/>*

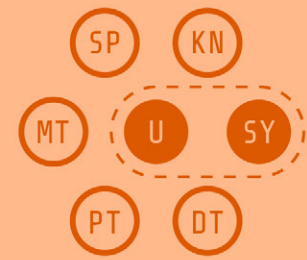
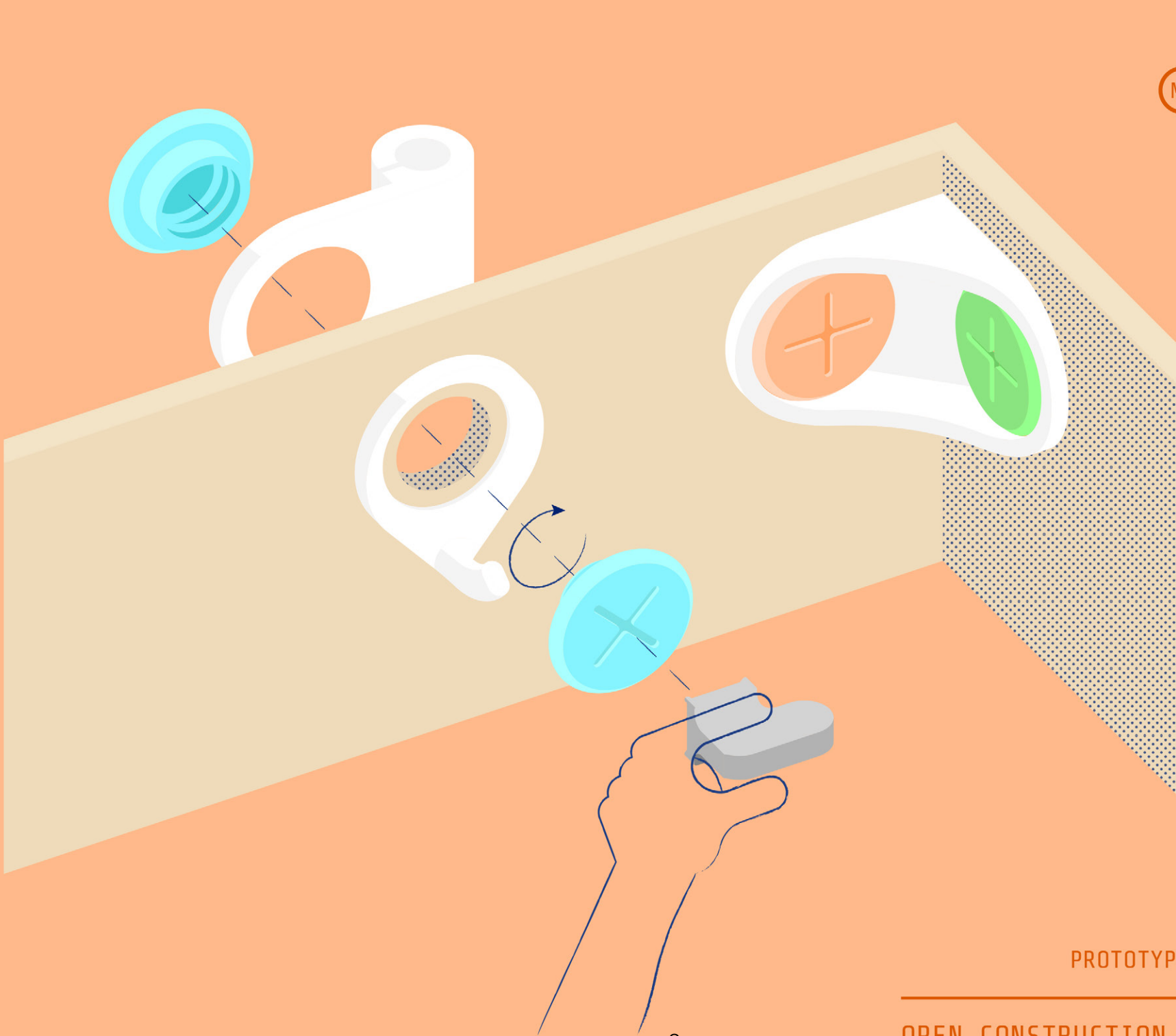

USERS  
+ SYSTEMS



## **PROTOTYPE 3: Open Construction Kit**

Can an open source, expandable kit of hardware make people excited to create and share designs? A core value of maker culture is the idea of openly sharing information (Hatch, 2013). It is important to not only make information accessible (such as digital design files), but encourage others to modify or improve this information, and finally sharing their own experiences and resources. Capitalism is protective about this, believing that information ownership is a zero-sum game (Rifkin 2015). Collaboratism however, believes that a common pool of informational resources that is constantly improving is of greatest importance.

Prototype 3 is a reusable kit of 3D printable hardware that is designed to attach to sheet material of any dimensions with minimal tooling. Inspired by the spirit of "adhocism", this kit works best with discarded scrap material such as plywood, to repurpose it into something useful. The oversized details and playful colours are designed to convey exactly how it is put together, and encourage even the least handy people to try to build their own structures. I used this kit to create two furniture-like pieces that were custom built exactly for my needs. (fig 3-13). The first is a desk divider with shelves and a lamp mount. The second is a partition that holds 3D printing equipment on one side, and coats on the side facing the entry area of the studio.

*fig 3-11: Prototype 3 overview diagram (source: by author)*



fig 3-12: Prototype 3 module details (source: by author)



fig 3-13: Prototype 3 possible assemblages (source: by author)

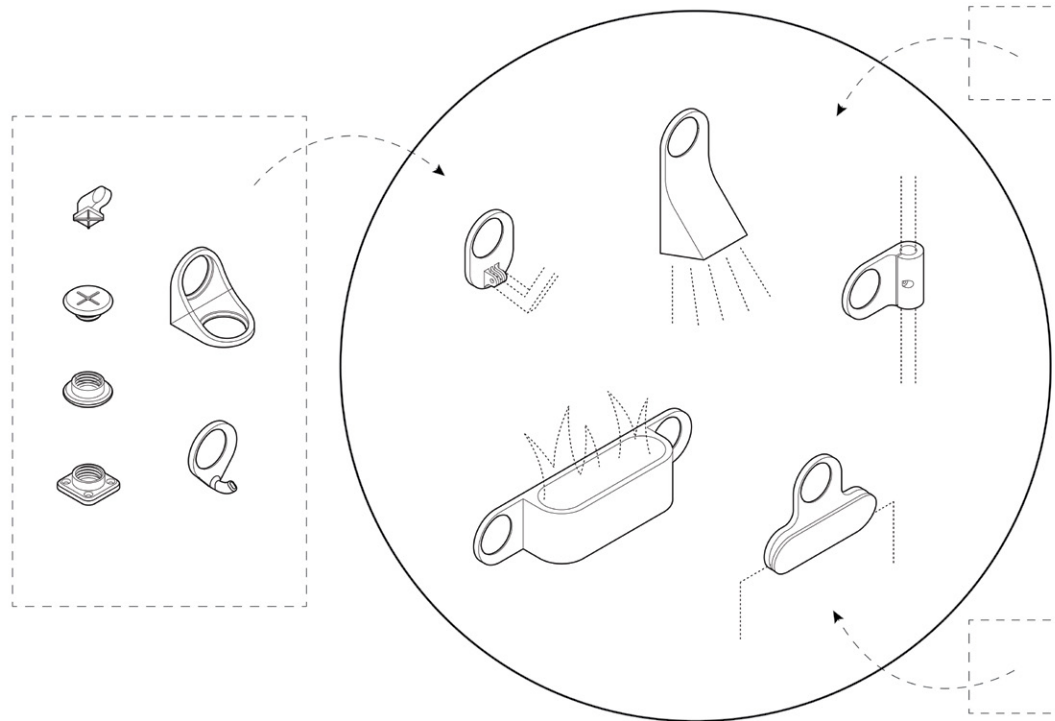

fig 3-14: Prototype 3 possible community contributions (source: by author)

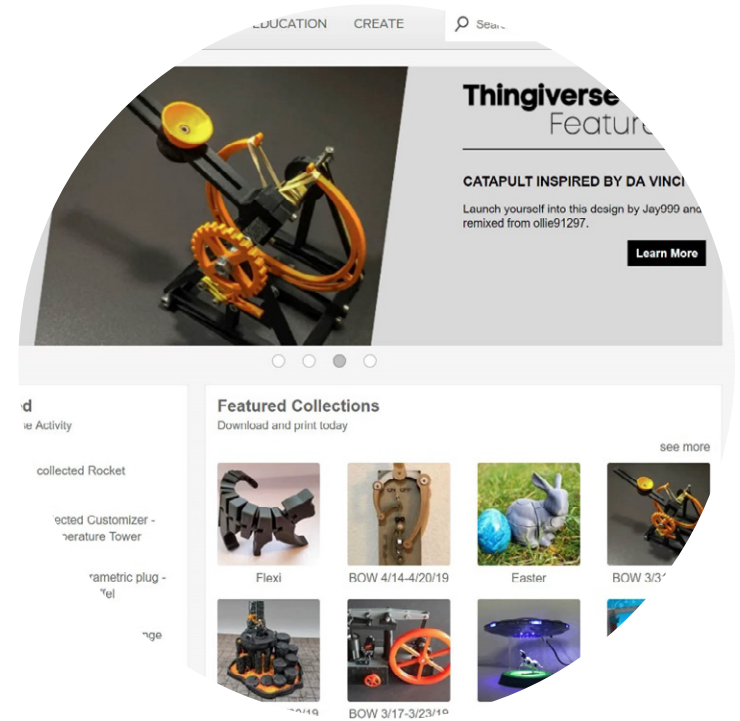
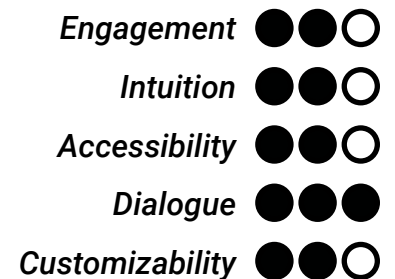

fig 3-15: Thingiverse, a popular model sharing platform (source: thingiverse.com)



The main module of the Open Construction Kit is are the colourful “buttons” that screw together, holding any number of attachments on either side. A wrench can also be printed to tighten these together. The only necessary tool to have is a drill with a hole saw bit. The parts are designed to be easily fabricated on the most entry-level 3D printers, with simple settings and lack of support material. The parts can be made-to-order for each project, or disassembled and reused.

Even with the flexibility of such a system, there is no way for myself, as a sole designer, to anticipate every user’s needs. Naturally, the next step is to share these designs with others. Ideally, they would be encouraged to develop and share their own designs and modifications. In fig 3-14 Ive illustrated some more possible user contributions to the kit. This can be done in person, but would have a much bigger impact on an online sharing platform such as Thingiverse (fig 3-15). The Open Construction Kit is not only is this a straightforward way to engage new users into making something larger, but also encourages making social connections and exemplifies the benefits of a sharing information.



*Resources for Prototype 3: <http://agontarz.com/p03/>*

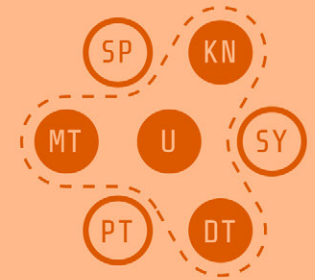
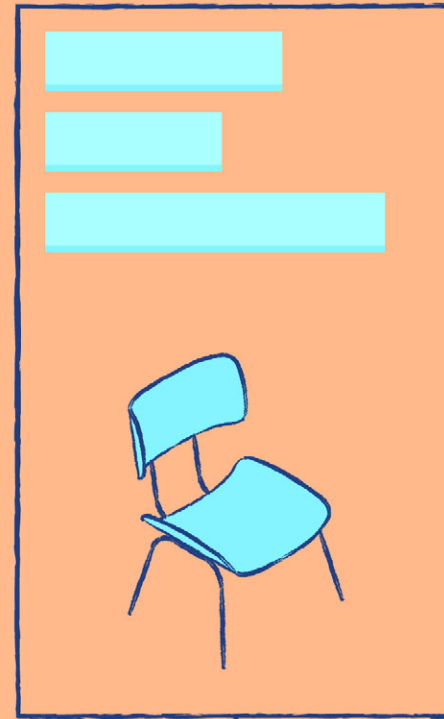
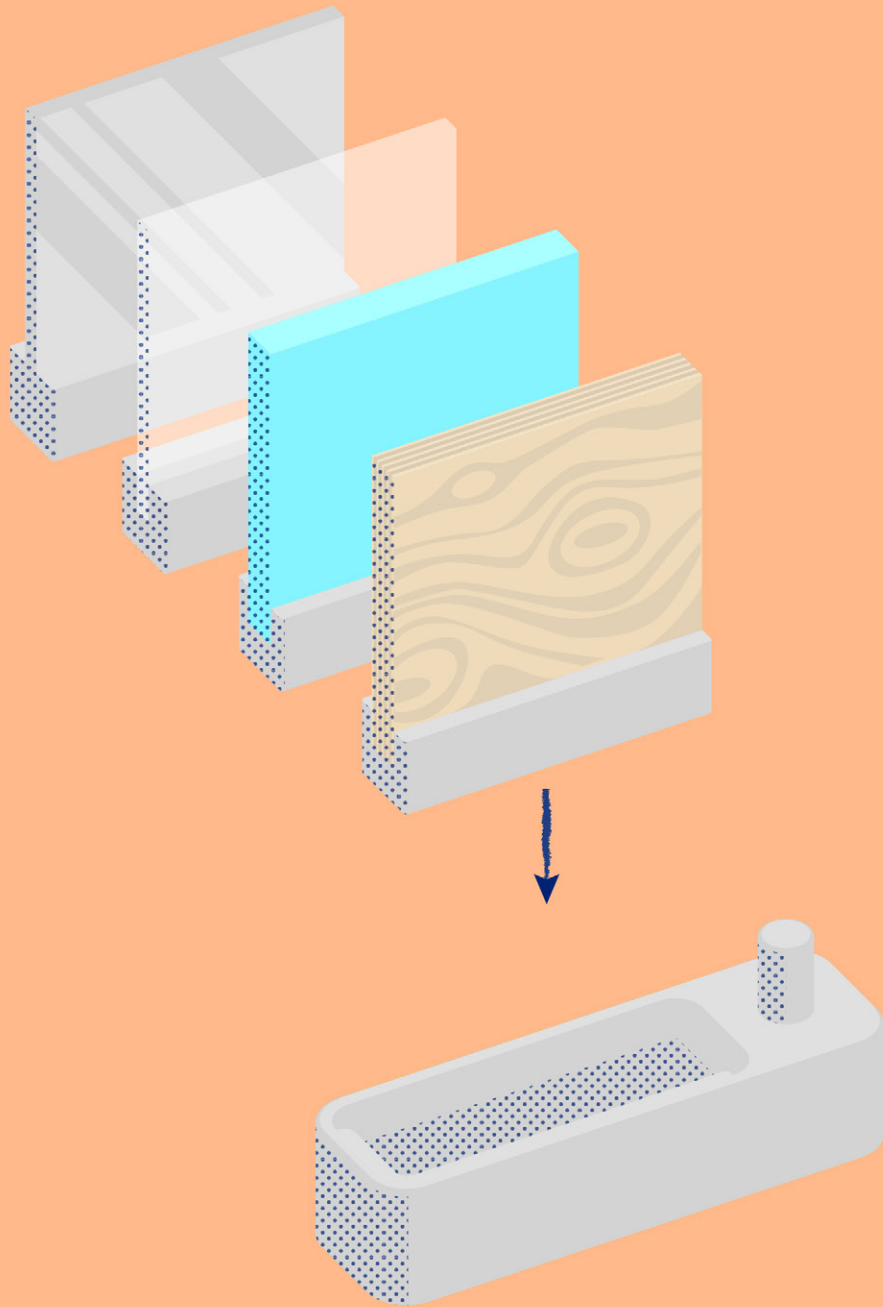

USERS  
+ MATERIALS  
+ KNOWLEDGE  
+ DESIGN TOOLS

PROTOTYPE-04

SMART MATERIAL LIBRARY



## **PROTOTYPE 4: Smart Material Library**

How can people gain a better understanding of what impact different materials have on a project?

Material selection can be extremely intimidating for a inexperienced maker. Each material has a unique set of properties that can benefit or hinder a project; such as durability, malleability, density, flexibility, hardness, etc. These properties not only affect the kinds of applications that are best suited for each material, but what tools and strategies are required to work with them. Even a material as seemingly straightforward as wood, there are hundreds of species which each behaves and reacts in its own way. (Shebani et al. 2009) For an experienced maker, material considerations often still require a great deal of research.

The Smart Material Library is a device and collection of samples that can not only give relevant information about materials, but show the information in relation to the user's particular project. When the user chooses the physical sample of the material and places it in the device, it will apply the material properties to their project, renders it live, and calculates metrics such as its weight, price, and carbon footprint. With this prototype, a user can have the experience of physically examining a real sample of the chosen material, instead of designing with an abstract understanding of it. They can then fully take advantage of a material database with computational abilities.

*fig 3-16: Prototype 4 overview diagram (source: by author)*

fig 3-17: Prototype 4 video (source: by author)

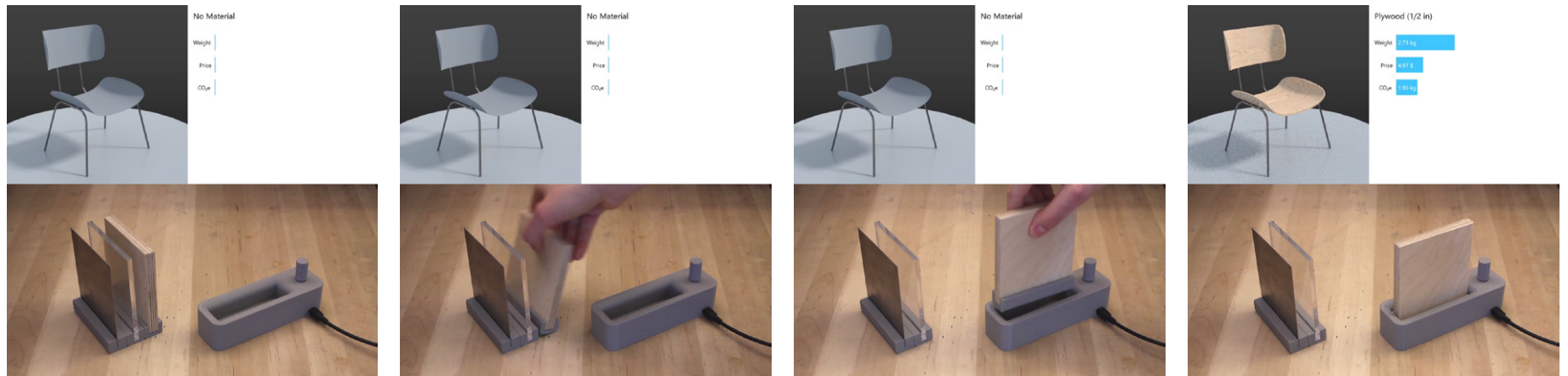

*user chooses wood*

*rotates the model*

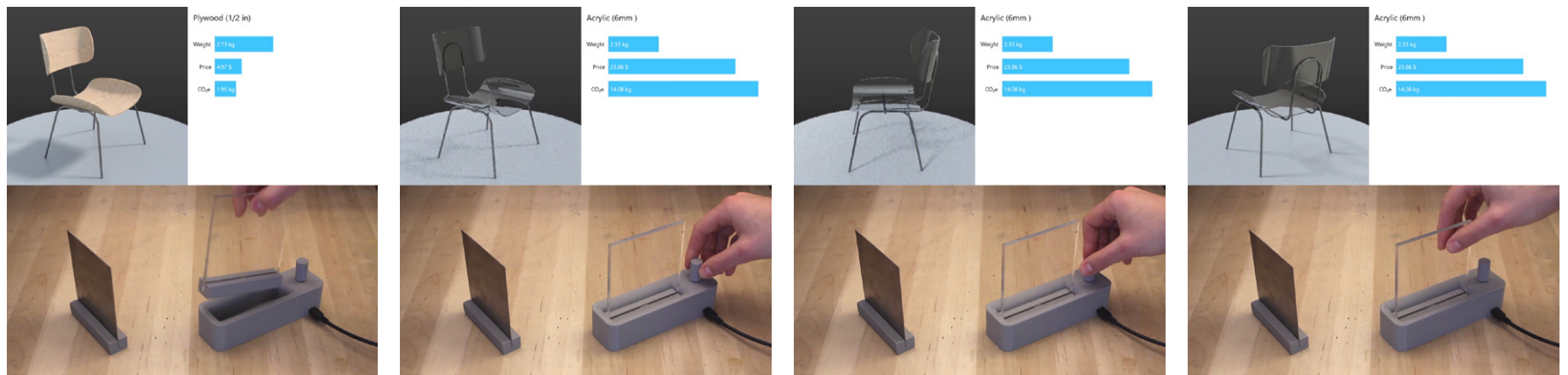

The Fabrication Commons: Creative Agency Through Intuitive Interfaces

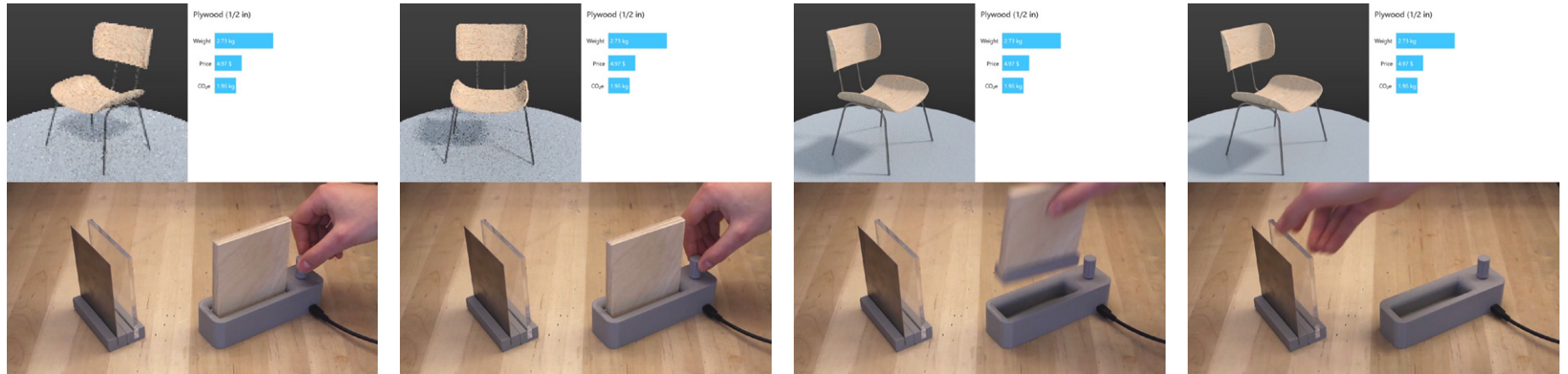

*user chooses plexi*

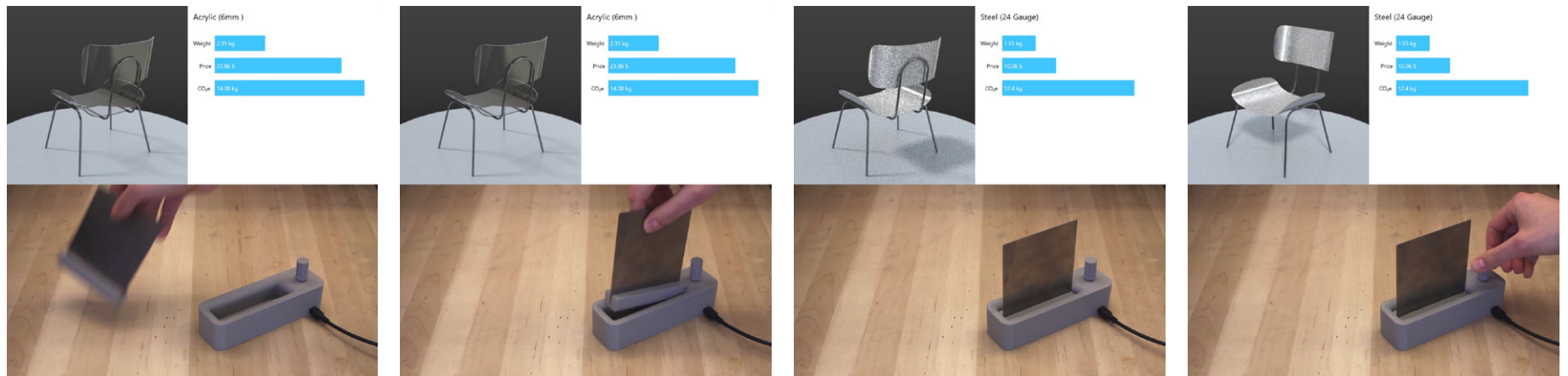

*user chooses metal*

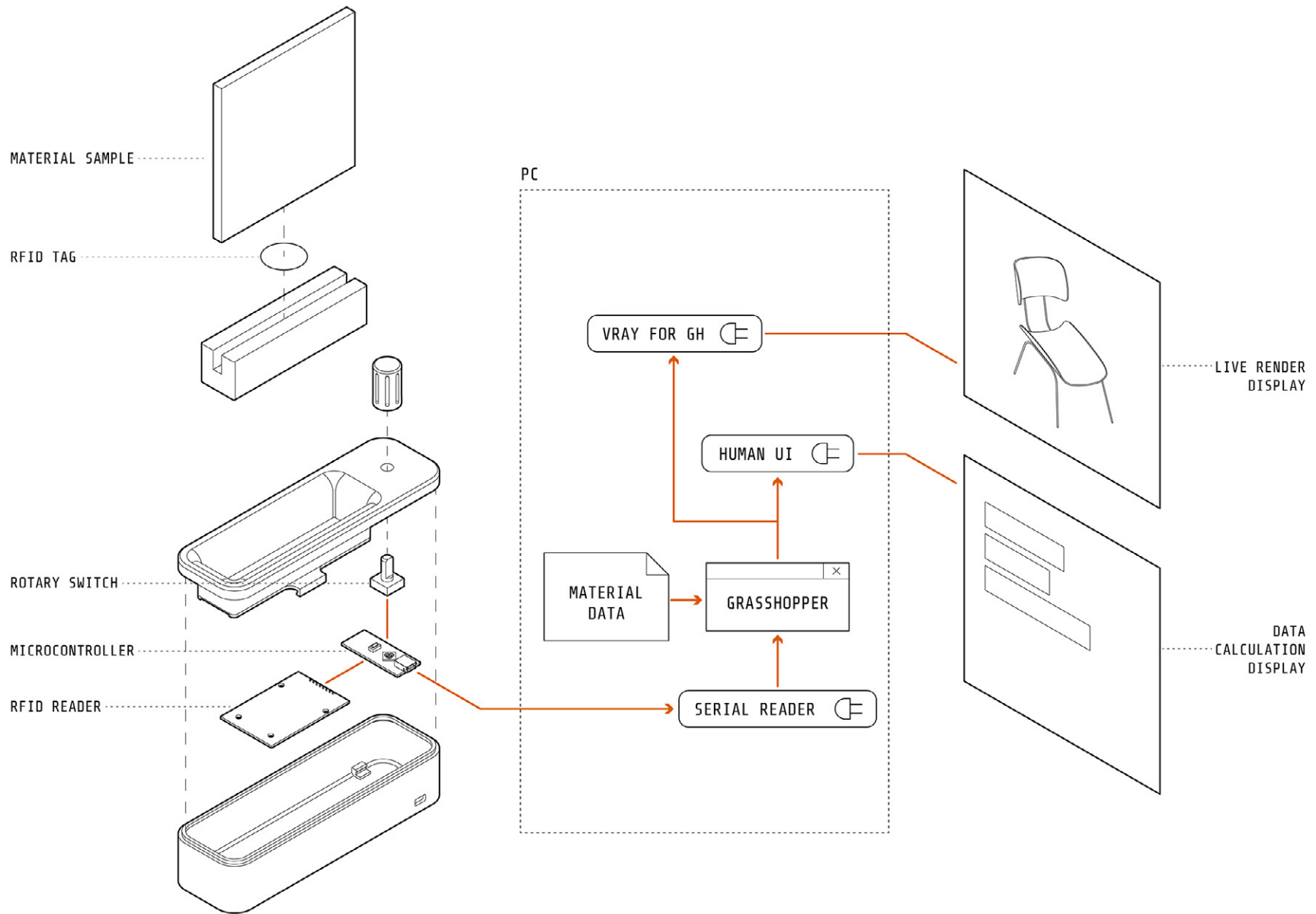

fig 3-18: Prototype 4 system diagram (source: by author)

The prototype consists of three samples, a receptacle, and a script which outputs the relevant information on a monitor. I chose three materials which are common but have varying properties. Attached to these samples are plastic caps which have RFID tags hidden inside, giving each sample a unique ID code. Inside the main enclosure is an Arduino microcontroller, an RFID reader and a rotary knob. When a sample is placed in the device, the material's ID is sent over to the computer.

On the computer side, the script gathers the ID data and cross-references it with the library of information that I organized. This consists of a digital material textures and a spreadsheet with metrics such as density, cost, thickness. The script applies the corresponding texture and thickness to modify the user's current project - in this case, a simple chair. The chair is rotated by the position of the rotary knob, and a rendering plugin is used to give an almost instantaneous visualization. At the same time, the new volume of the 3d model is taken, and using the previous metrics, more information can be computed. In this case the weight, price, and carbon footprint (in CO<sub>2</sub>e) is calculated and displayed for the user with a UI plugin. This entire process happens within a matter of seconds of the user placing a sample in the device.

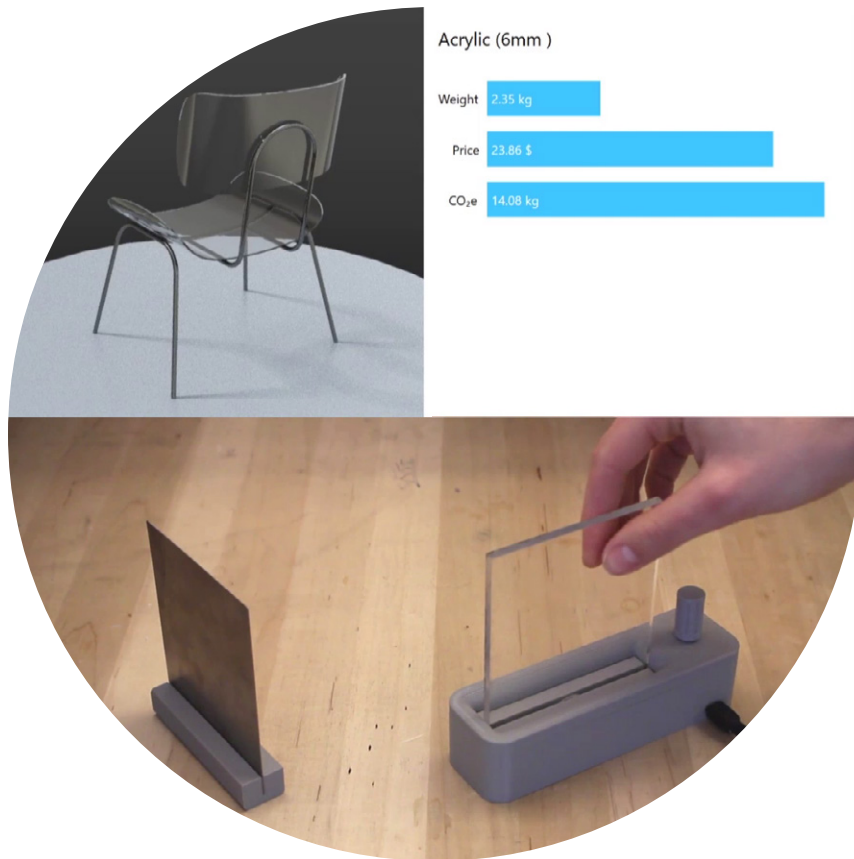

fig 3-19: Prototype 4 detail (source: by author)



fig 3-20: Prototype 4 future version (source: by author)



A smart material library such as this could prove to be beneficial in many environments. People that have interacted with this prototype mentioned that they could envision this to be a tool for designers and their clients to have an interactive discourse about materials for their projects. For the *fabrication commons* that I am proposing, I believe that this tool would provide insight and depth to the material selection process of novices and advanced makers alike.

A future version of this prototype would not only be integrated with the user's projects, but fully integrated with the *fabrication commons* ecosystem as well. Each material can correspond to actual available stock within the commons, or connect the user with someone that has experience and extra material to share. Materials from different industries would all converge in this system, like textiles, woodworking, or ceramics. Other features of this new version would allow it to perform more complex calculations. For example, it would include the ability to create assemblies out of multiple materials (fig3-20), and inform the user about how they come together and function. Another possibility for the future version is the ability to run physical simulations to see how each material would perform structurally. Hopefully this can be an informational tool, simplify the making process, and encourage even experienced users to experiment with new materials and strategies.

Resources for Prototype 4: <http://agontarz.com/p04/>

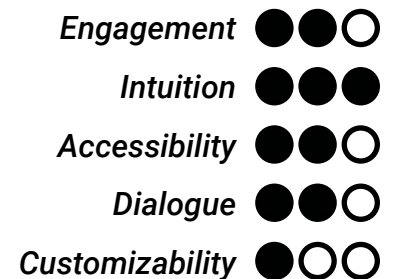

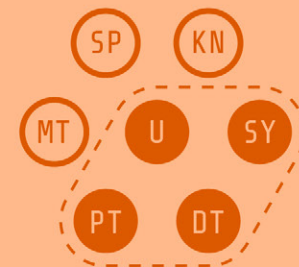
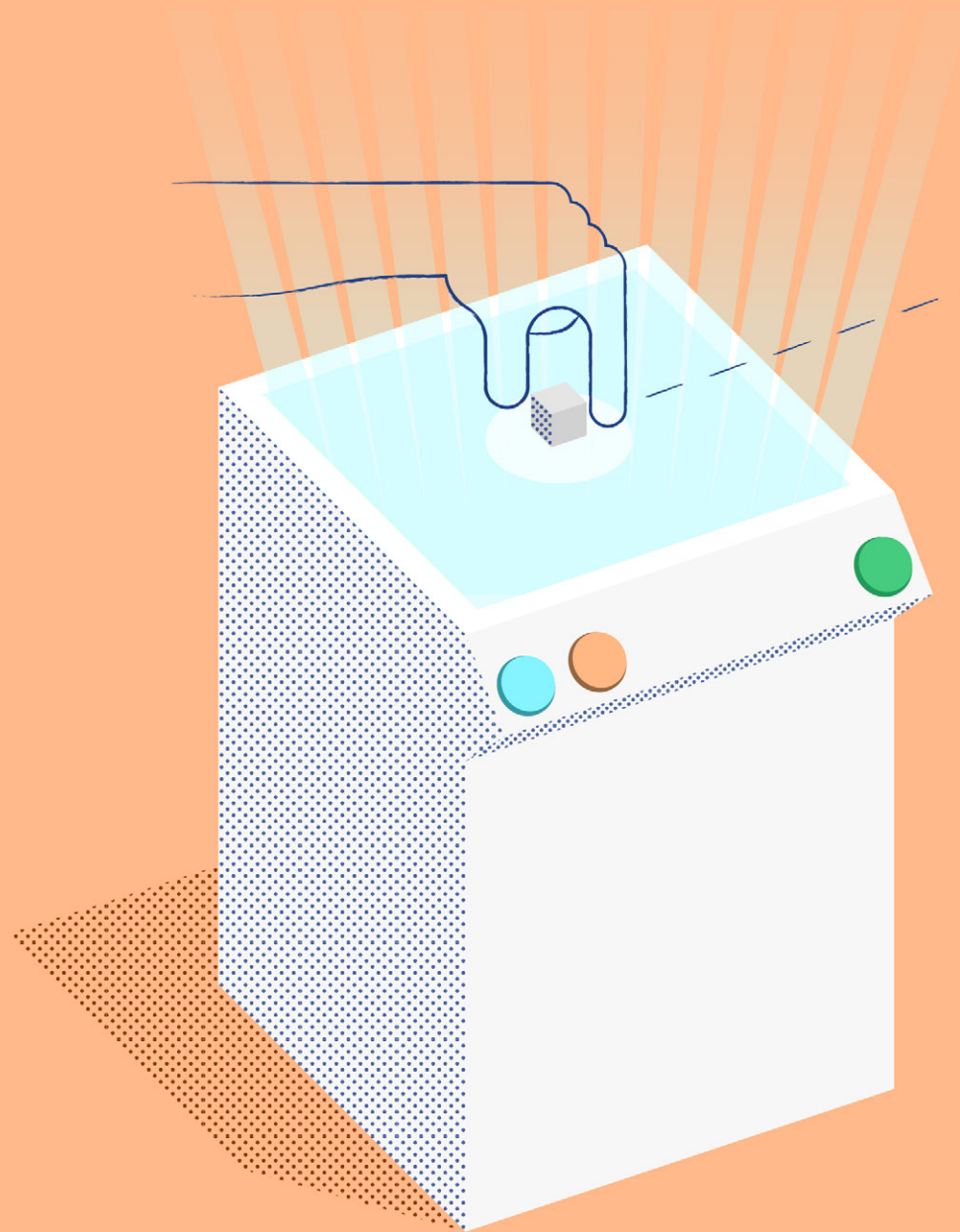

USERS  
+ SYSTEMS  
+ DESIGN TOOLS  
+ PHYSICAL TOOLS

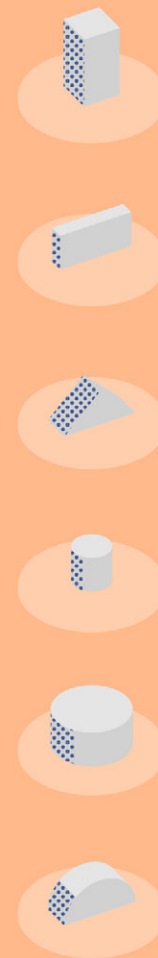

PROTOTYPE-05

TACTILE DESIGNER



## **PROTOTYPE 5: Tactile Designer**

How can a user experience the entire design-fabrication workflow with no prior design or fabrication experience? Usually, the way new users are encouraged to use a digital fabrication tool (such as a 3D printer) is to find a ready-made file online to print. In my experience, I have noticed that once a new user prints a few models of their choosing, they lose interest, because they don't see themselves as designers but merely as executors. This could be because they cannot imagine themselves actually designing an object that is truly adapted to their own needs and desires. This is why it is crucial to illustrate the entire workflow from start to finish, making it as simple as possible while still allowing the user to make decisions that will affect the final product.

The Tactile Designer is an interface tool that does exactly this. Users can choose from a wide variety of pieces, add them in any way they wish, and send it to the printer with the press of a button. The pieces are at the exact scale they will be printed, and display the final product on a screen as the user builds. When the green button is pressed, the program converts the model into code that is readable by the printer, and queues it up to print.

*fig 3-21: Prototype 5 overview diagram (source: by author)*

fig 3-22: Prototype 5 video (source: by author)

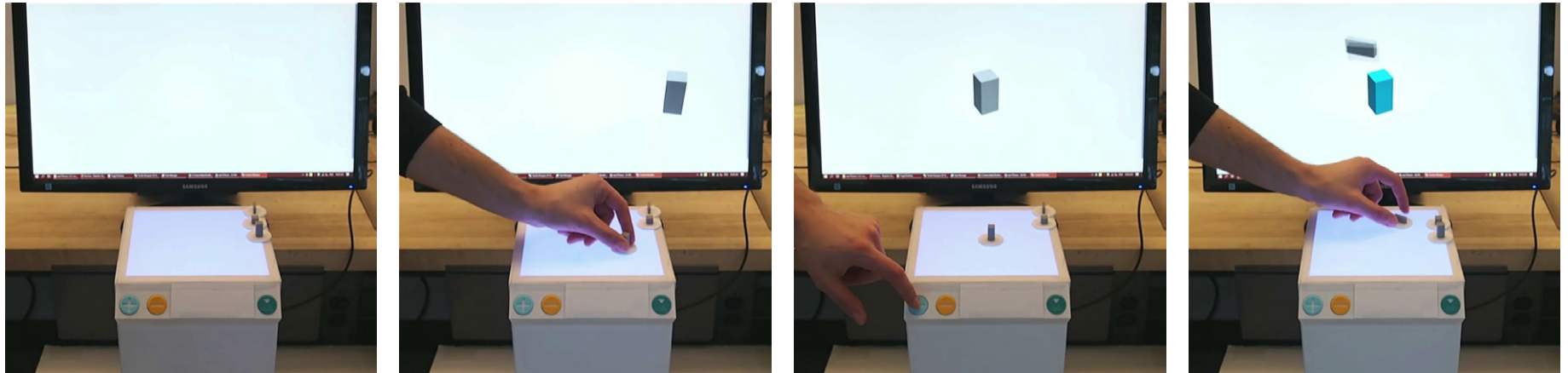

*the user chooses a part and builds a model*

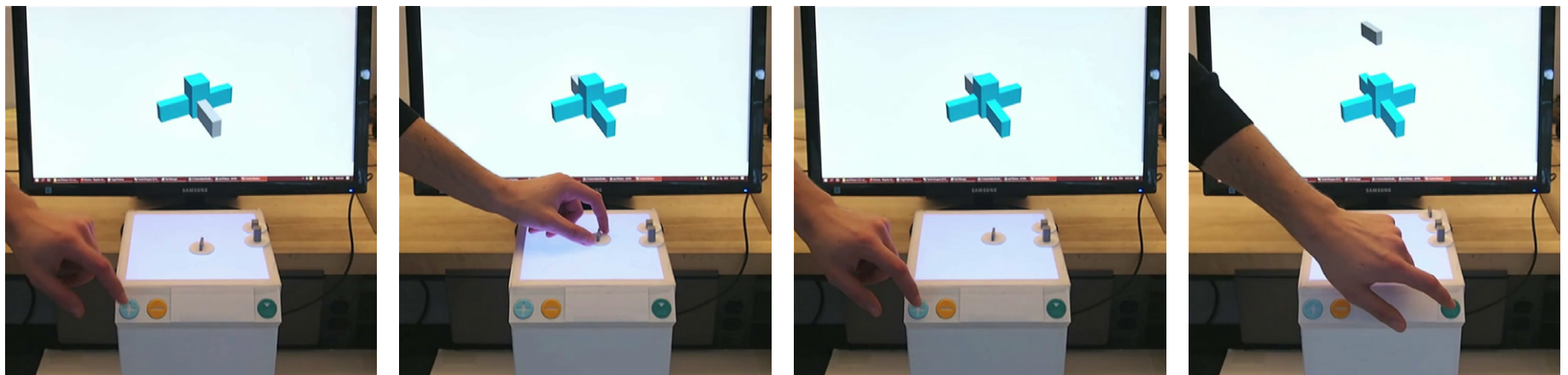

*design sent to printer*

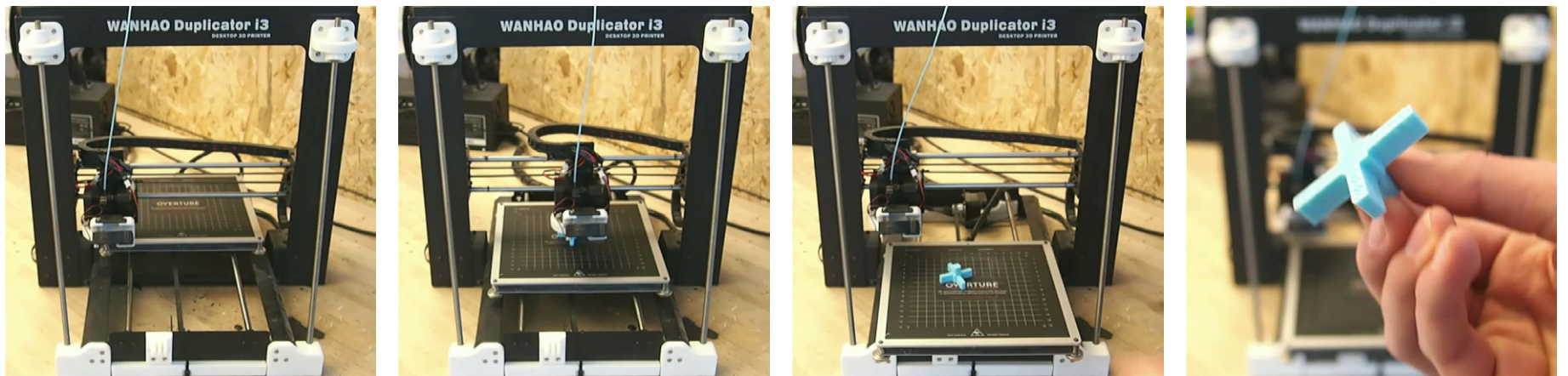
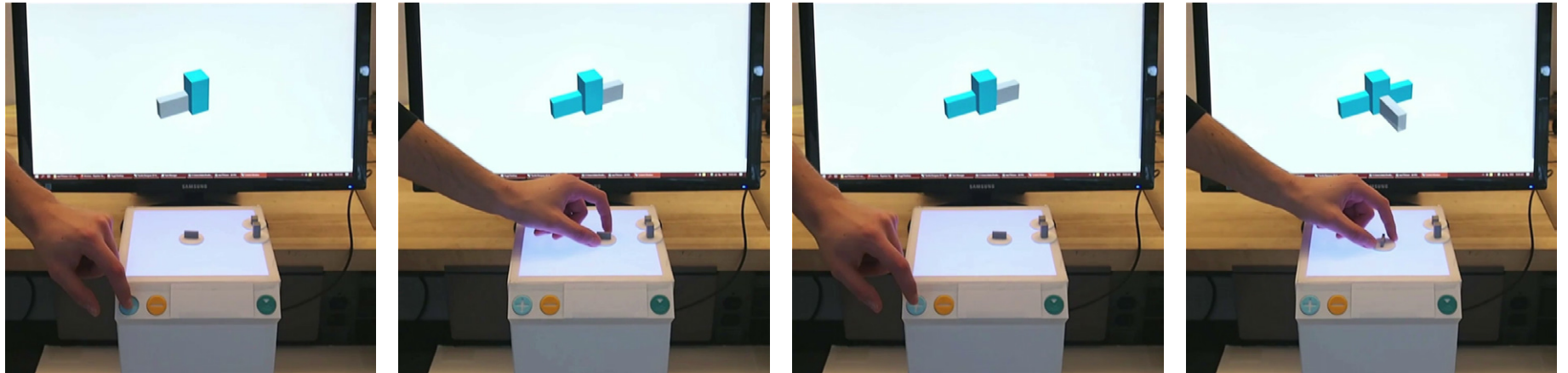

3D model is printed

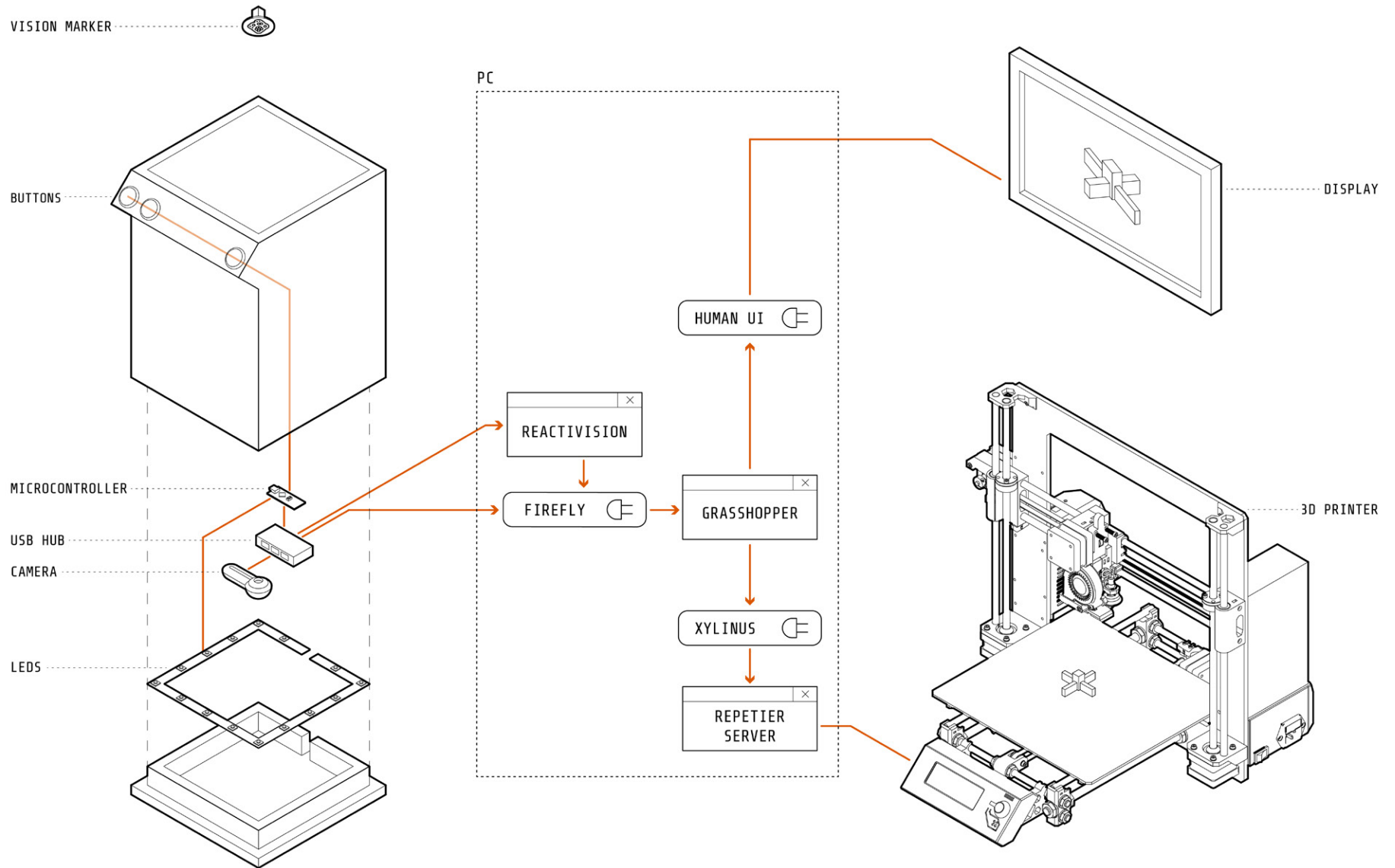

fig 3-23: Prototype 5 system diagram (source: by author)

The Tactile Designer device is a white box with a plastic translucent panel on the top, and a series of buttons on the front. Inside the housing is a microcontroller, a USB hub, a webcam, and a strip of LED lights. The webcam streams the image from inside the box to a tracking program, illuminated by the LEDs to increase the contrast. When the user places a piece on top, the program translates the visual marker on the underside of the piece to an ID and coordinates. These are sent to a script which recreates a 3d version of the piece in the proper position and orientation. This is then displayed through a UI plugin in real time. The next step is to build on this one piece. When the user presses the "add" button, the position of the piece is locked in place. Subsequent presses will make new instances, and combine them into a single model.

When the user is satisfied with the model, they press the "print" button. When the button is pressed, a plugin generates printing instructions (gcode) within the script, saves this to a file, then runs a command for the computer to send the file to a local print server via API, that is already connected to the printer. Using a server such as this also allows us to bundle additional instructions to start printing right away without any additional user input.



fig 3-24: Prototype 5 detail (source: by author)

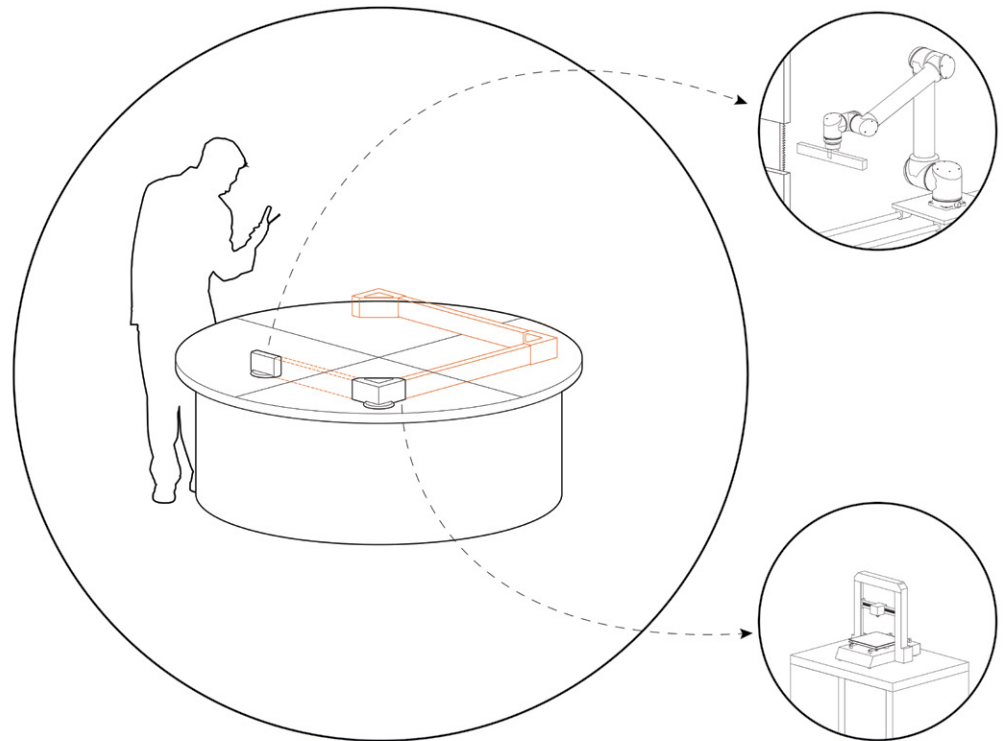

fig 3-25: Prototype 5 future version (source: by author)



The Tactile Designer could prove to be a useful tool in current makerspaces, and eventually in the proposed *Fabrication Commons*. It would be used by novice makers to become comfortable with the entire design-fabrication workflow. Also, it could be used by more experienced makers to quickly prototype rough ideas without the need to use more complex software. This prototype has some of the potential social benefits of prototype 1, where multiple people could be engaged in the design process at once.

This prototype has some limitations that could be improved upon in the next version. First of all, it could support more than one type of material. This would also require a connection to a different fabrication tool or process for each material. The diagram in fig 3-25 illustrates a design being dispatched to a 3D printer for plastic parts, and to a robotic arm that cuts wooden parts. Increased accuracy of the design could be achieved with a more intelligent system for snapping and dimensioning. The screen could be upgraded with an augmented reality overlay of the design on the surface of the table as its being built.

The Tactile Designer shows users the entire design-fabrication workflow in a clear, unintimidating way. With a series of pieces to choose from, a novice can create a unique shape without ever touching and code or advanced software.

Resources for Prototype 5: <http://agontarz.com/p05/>

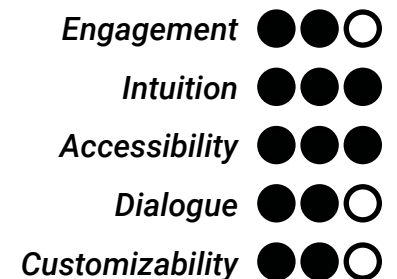

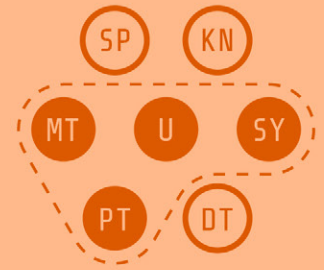
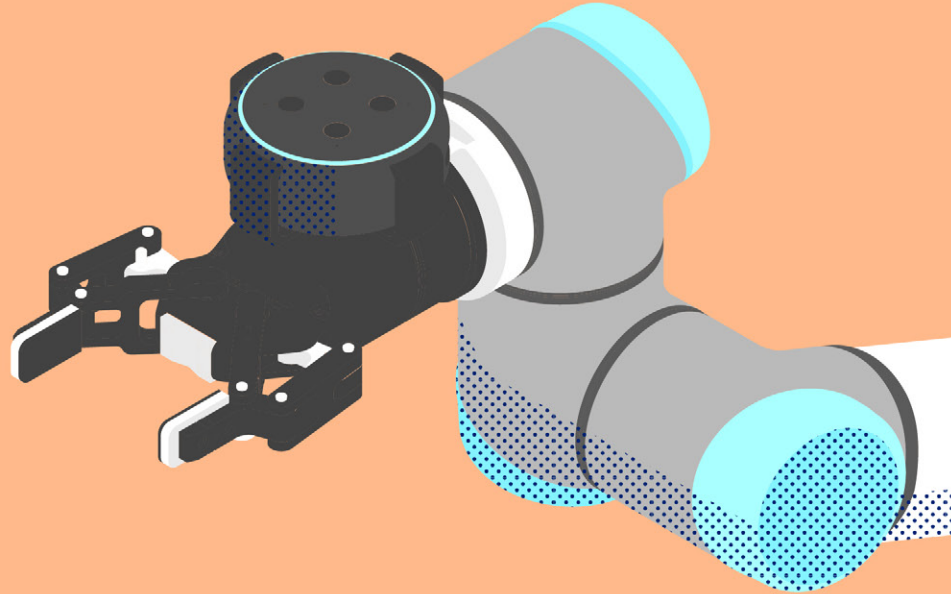
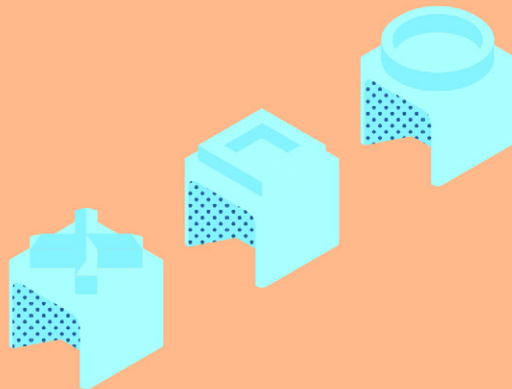
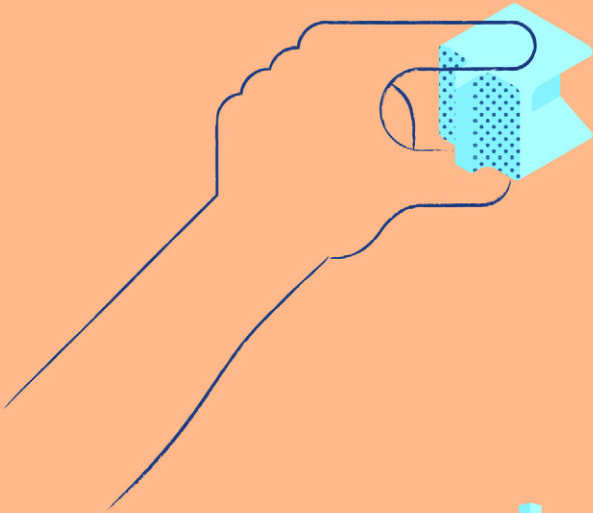
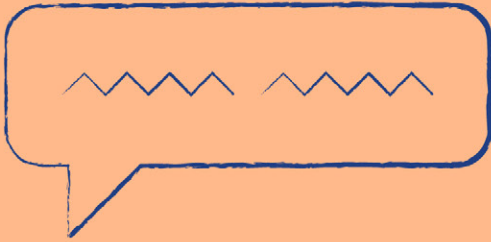
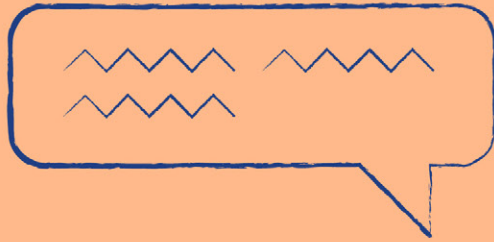

USERS  
+ PHYSICAL TOOLS  
+ MATERIALS  
+ SYSTEMS



## **PROTOTYPE 6: Robotic Coworking**

How can a user work with a robot as a co-worker to produce something with both robotic and human traits? Digital fabrication tools are becoming more versatile, affordable, and user-friendly. A new type of robot, the collaborative robot or "cobot", aims to be a tool that can safely work in the same space as a human user. However, the robotic arm still has a reputation from the first industrial revolutions as an unintelligent, ruthless machine. Much has changed since then: advances in sensing technology allows for these machines to have an awareness and adapt to their surroundings (He and Chen, 2018). This, combined with more human interfaces such as voice and touch, would allow for a more relaxed and productive relationship between the human and the robot. Building trust between the two parties is key to fully taking advantage of the strengths of both the human and the machine.

The primary focus on this prototype was the interaction between the user and the UR robot, and secondly was the product – clay, in this test – which is being modified by both the user and the robot. First, the user molds a piece of clay, and its shape is registered by a webcam with a simple vision system. The robot prompts the user to choose a tooling piece and hand it over. After checking in with the user again, the robot stamps around the perimeter of the clay.

*fig 3-26: Prototype 6 overview diagrams (source: by author)*

fig 3-27: Prototype 6 video (source: by author)

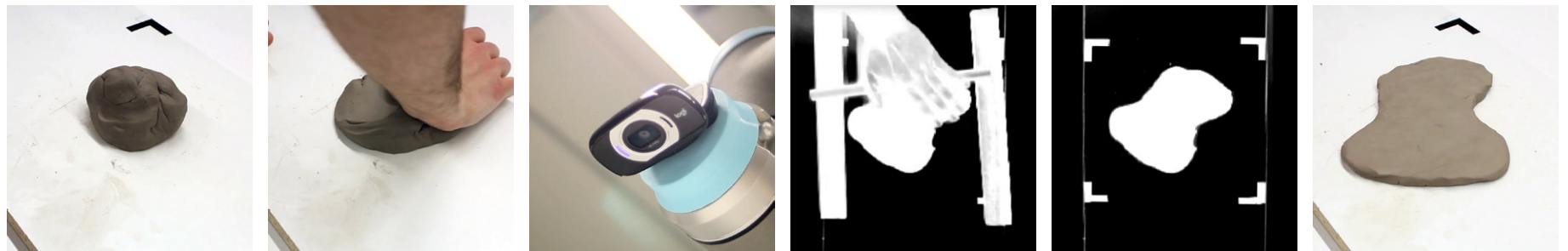

*shaping the clay by hand*

*camera with vision plugin translates the clay shape*

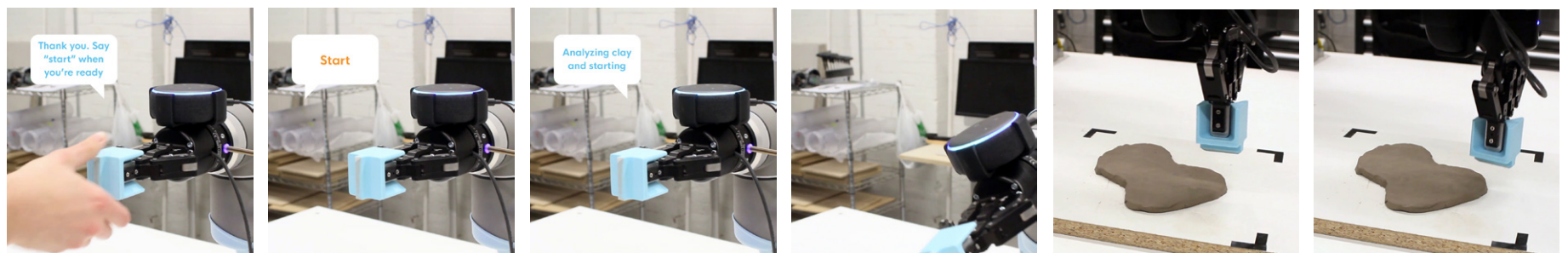

*the robot applies the pattern to the clay*



*a physical and conversational interaction confirms the tool*

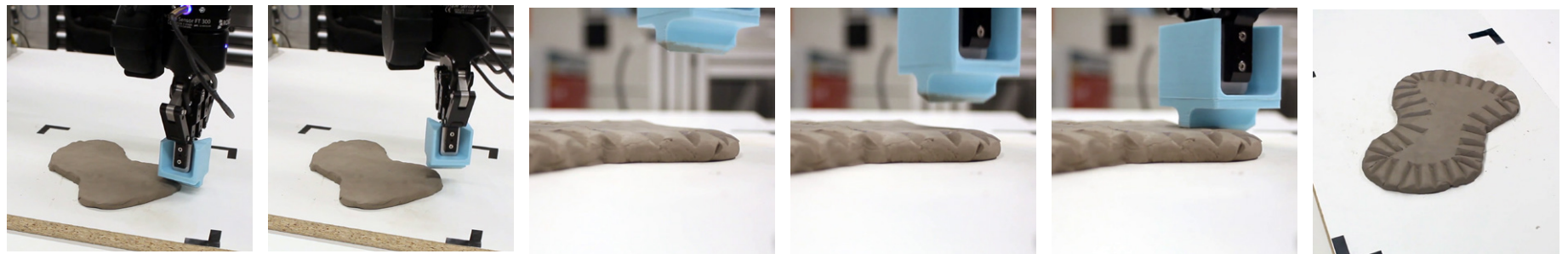

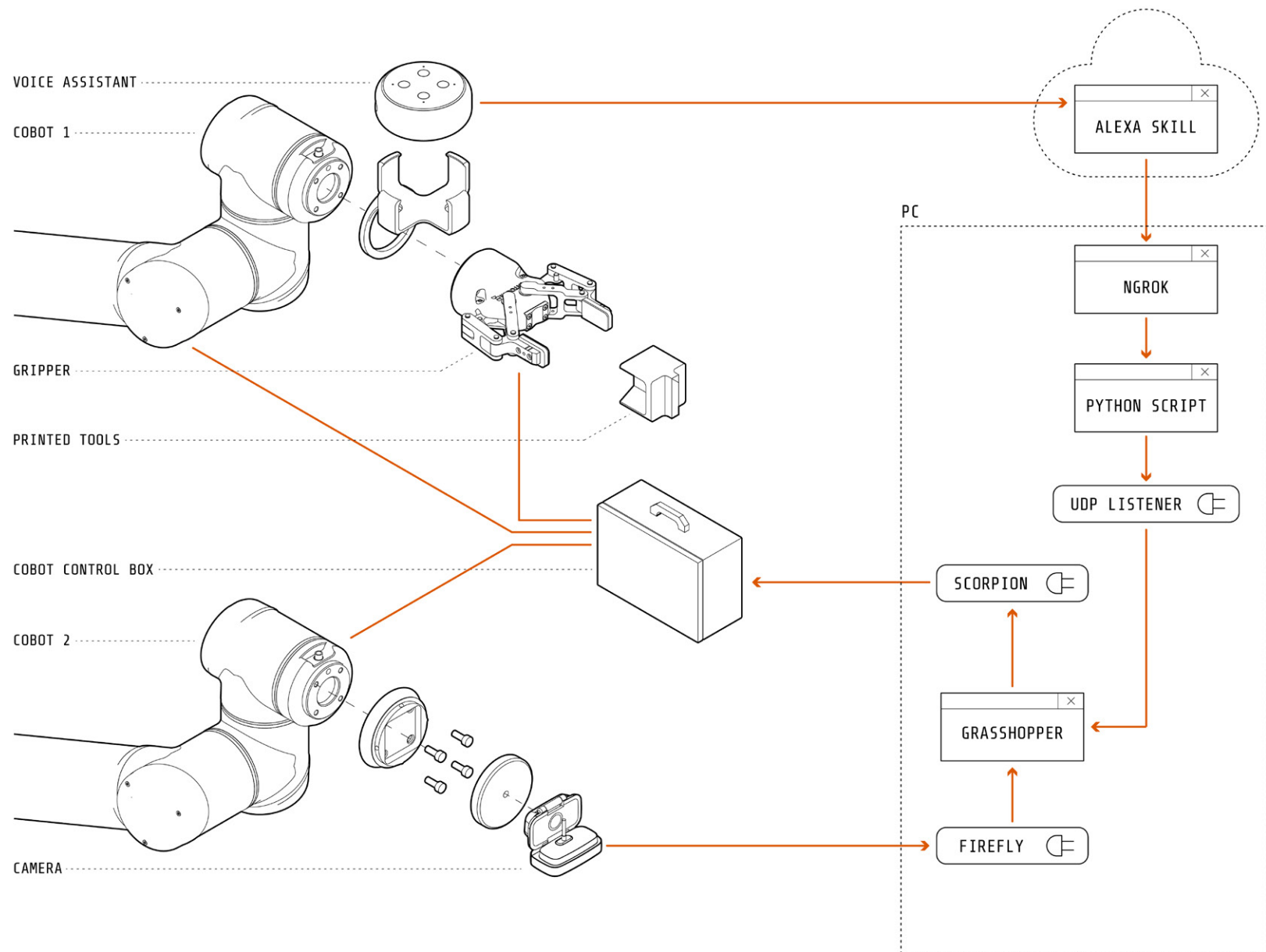

fig 3-28: Prototype 6 system diagram (source: by author)

The first stage of this system is vision over the workspace. A webcam is attached to the secondary cobot, sending the image to the script which then converts the image into a outline vector. Once the clay is represented digitally, any number of adaptive designs can be applied - in this case, a perpendicular stamping along the perimeter of the form.

The next challenge was to design a voice interface. I created a voice app using the Alexa Skills service, which interprets voice commands that it can send to a local script through a local server. The app interprets the user's voice using "intents", which can generally approximate the voice command to the nearest option that it is expecting (For example, "Start", "Go", "Go Ahead" would all be equated to the same command) In the local script, I wrote a simple dialogue tree with multiple options for the user, which would can lead to multiple outcomes for the robot's actions (For example, "yes" starts the motion, "no" exits the program.)

Finally, commands are sent to the robot or the gripper with a plugin through a hard-wired connection. When the user is finally ready for the tooling of the clay, the toolpaths are converted to commands in the native language of the robot.



fig 3-29: Prototype 6 detail (source: by author)

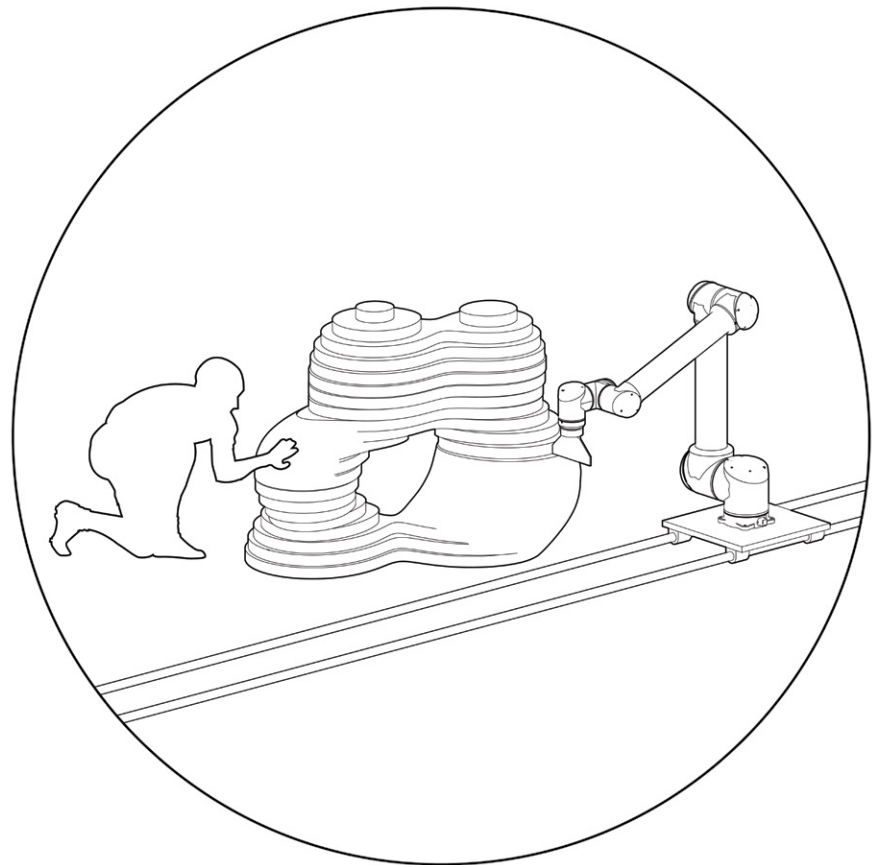
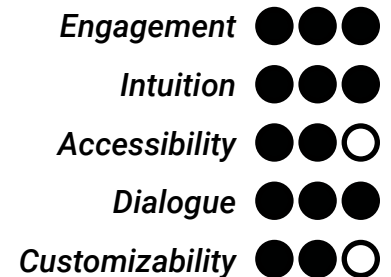

fig 3-30: Prototype 6 future version (source: by author)



Hopefully, robots will surpass their rigid applications in industrial settings, and find themselves in more spaces of public access in the future. This prototype creates a simple output that shows the contribution of both human and machine. However, it is limited to a small work area and a short interaction. A future version could expand on this process to create more exciting products. A fully three-dimensional awareness of the space that it is working in, as well as an awareness of the people sharing the space would be a desirable upgrade. This would make the process safer, and allow the robots to be animated towards the users. Most importantly, it would allow for a simultaneous workflow, where instead of a back-and-forth, the robots and users can be working on a project at the same time.

The full potential of collaborative robots can be taken advantage of using sensing and networking technology. By designing these interfaces, we can build trust and benefit from the unique combination of human creativity and decision making, with robotic precision and speed.



Resources for Prototype 6: <http://agontarz.com/p06/>

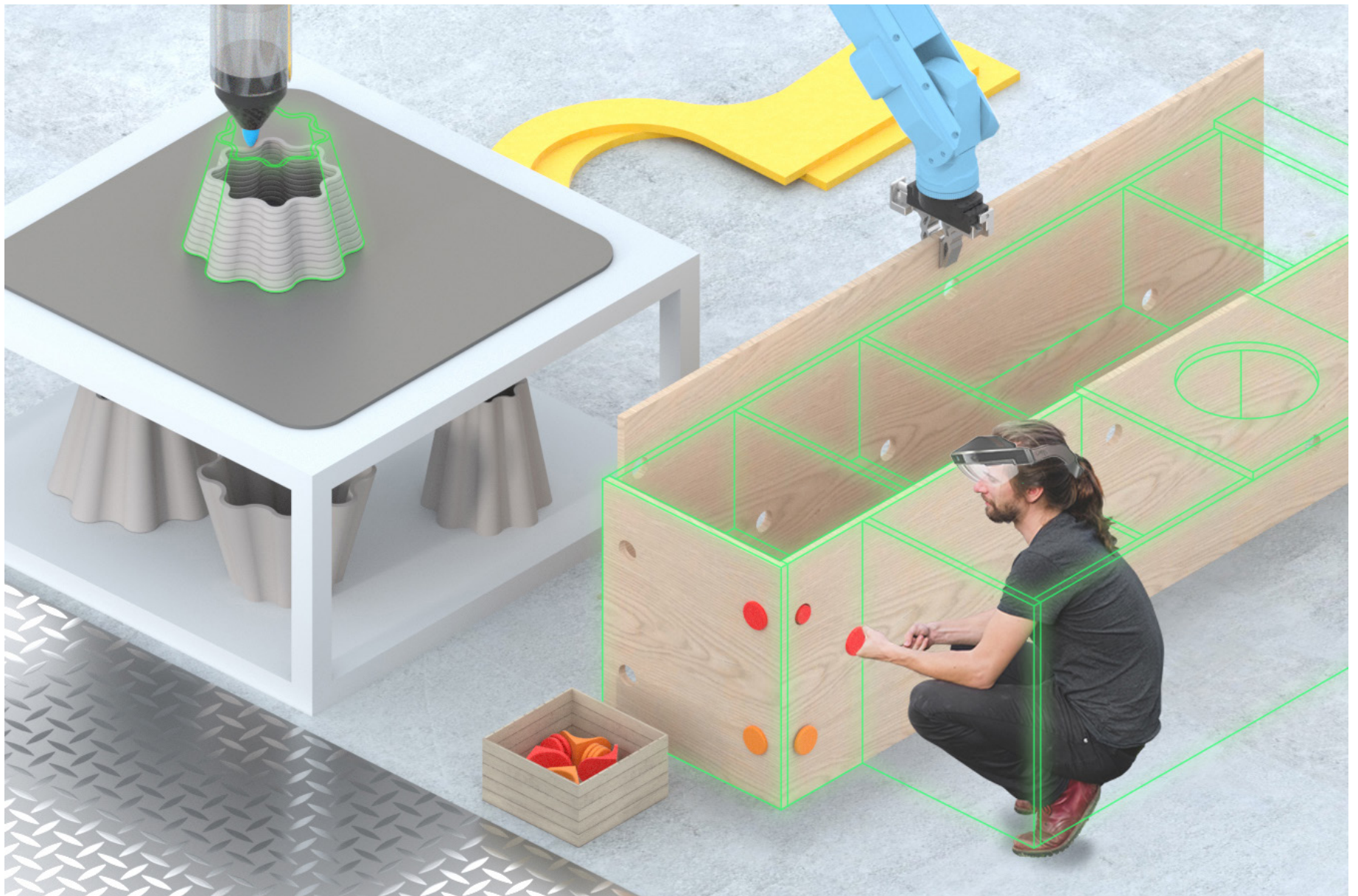

fig 4-1: Vignette 1: the Fabrication Commons (source: by author)

## CHAPTER 4: Discussion

From my very limited testing, the prototypes successfully engaged the user by using simple intuitive interfaces. In addition, people were excited about the possible implications of these prototypes. Without a prompt, they imagined the types of people that would benefit from them and environments that they would be useful in. However, most students of architecture already have some experience with these processes. A logical next phase for testing would be in places where people of various skill levels would be, and possible new makers could be initiated with the help of the prototypes: places such as libraries, community centres, museums, or makerspaces.

Each prototype attempts to combine and lower the barriers between the user and a combination of other elements of the design-fabrication process. They each focus on some of the aspects that make up the spirit of making - like sharing information, collaboration, mass customization, education, ease of use, fun - and together reflect the values of the *Fabrication Commons*.

The following vignettes place the prototypes in a larger context again. The two visualizations (fig 4-1 & 4-2) imagine how an accessible *fabrication commons* might be used to allow for people to create objects to suit their particular lifestyles. The objects in fig 4-1 are being created with some of the future versions of the interface tools, and appear in fig 4-2 in a domestic setting, reflecting the needs and tastes of its occupants.

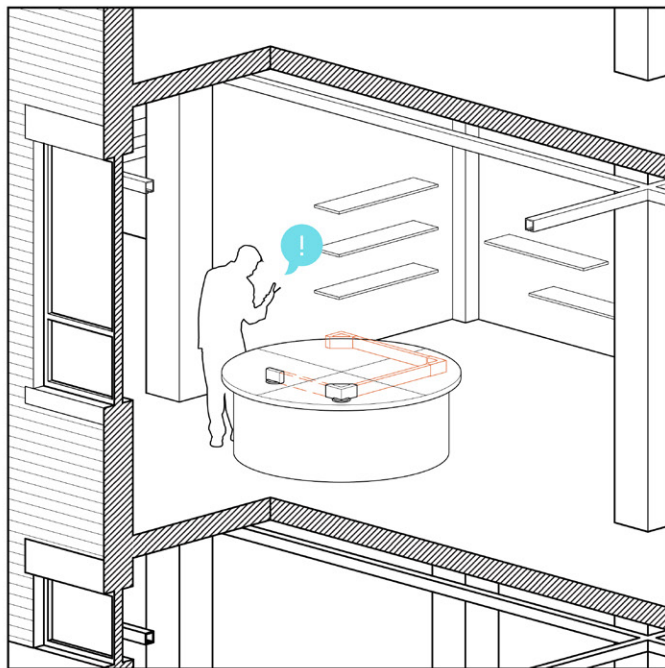

fig 4-2: Vignette 2: the Hacked Home (source: by author)

These drawings on the following pages (figs 4-3 to 4-6) imagine possible interactions between users of the *fabrication commons*.

Drawing 4-3 illustrates two people living in different cities exchanging information about how to build an interface tool for their respective *fabrication commons*, to engage more people in their local community. This interaction is based on a real online conversation I had with a student in India about prototype 4, the Tactile Designer. Drawing 4-4 illustrates an example of a differently-abled user sharing their hacks with an online community with similar needs. Designs are exchanged and modified, and improved by community members. This type of community is simultaneously global and local. Drawing 4-5 shows a user of the *fabrication commons* creating and displaying a project in the gallery space. The project catches the attention of a local to the community visiting the building, who contacts the maker to commission a piece in the same style.

With these vignettes of people making, sharing, learning and interacting, we can start to form an idea of how a community of empowered, connected creators would look like (fig 4-6). Any neighbourhood can benefit from a building or space of a suitable size, creating a growing group of makers. These local communities would be connected virtually with the global network of other *fabrication commons* spaces around the world.



Hello! I was wondering if you could share how you built the Tactile Designer. This would be great to have in our local FC!

Of course! All of the files and instructions are available on our FC server. I'll send you a link.  
TORONTO-FC/tactiledesigner

Thank you! These are really clear. Will this work at a smaller dimension, or are there any changes I have to make?

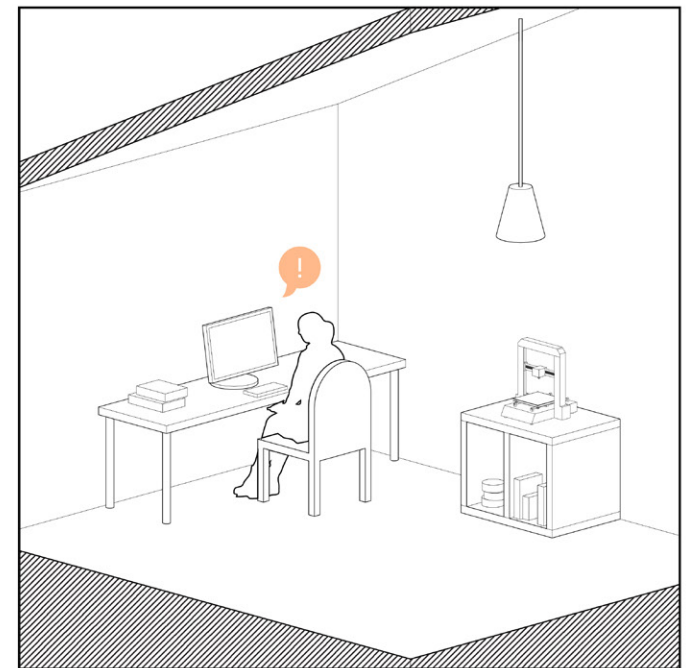

fig 4-3: Community interaction #1 (source: by author)

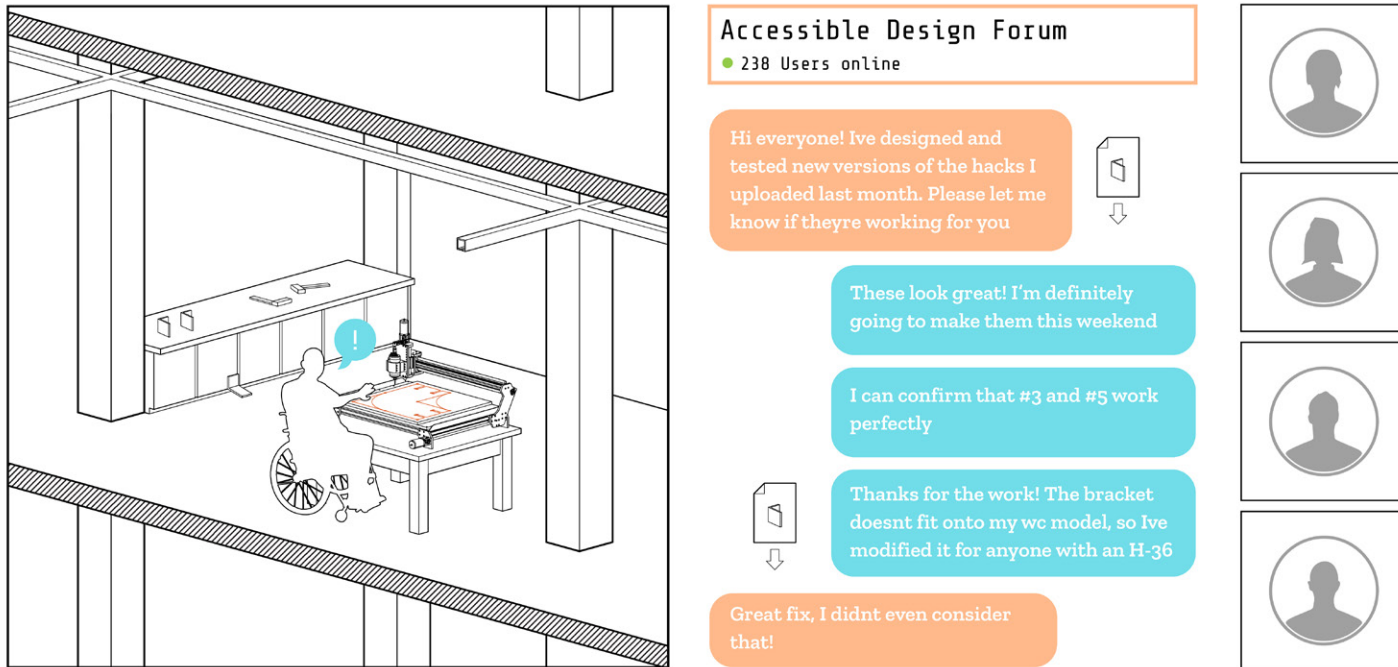
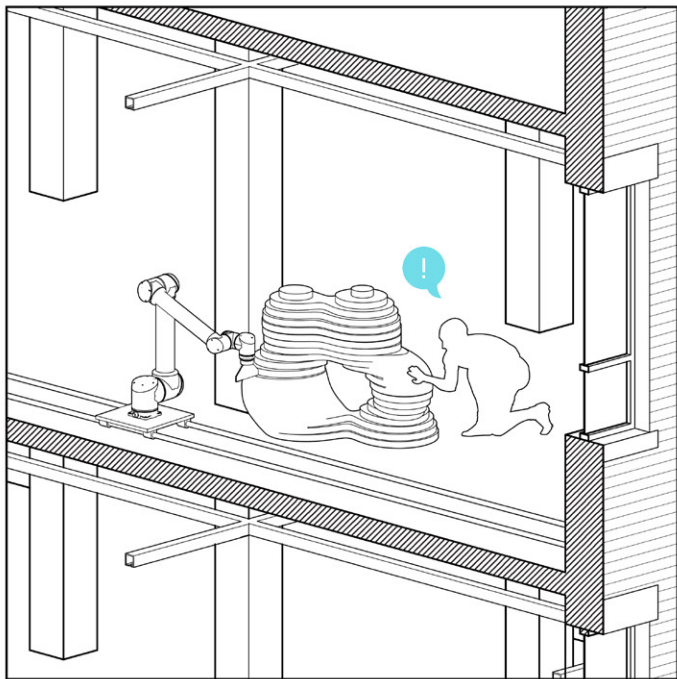

fig 4-4: Community interaction #2 (source: by author)



Good evening, I saw your funky chair design in the FC gallery space. Do you do commission work? This would be wonderful to have in our new office space

Thanks, I'm glad you like it! I'm still experimenting with this particular technique, but I can definitely do a commission once I get it right.

Great, can you please let me know when you are ready?

Absolutely, and you can tap here to take you to where I keep my project progress. I have it updated quite often

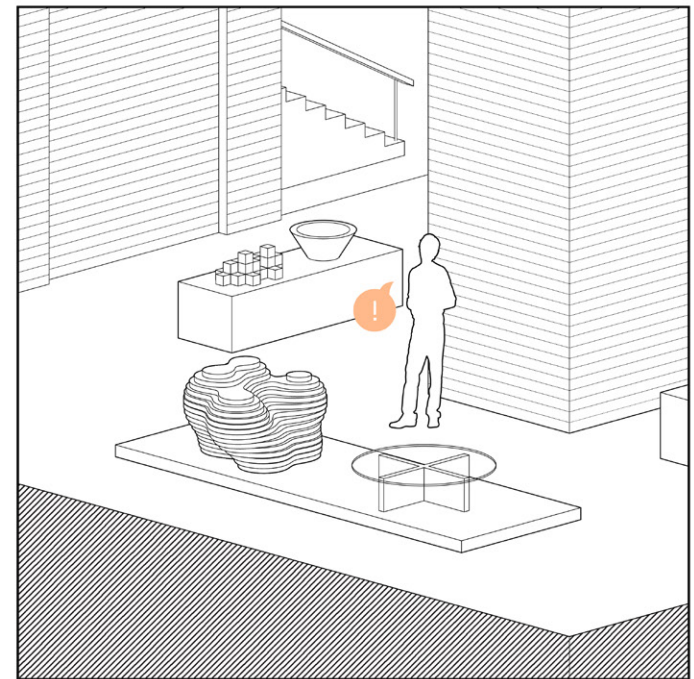

fig 4-5: Community interaction #3 (source: by author)



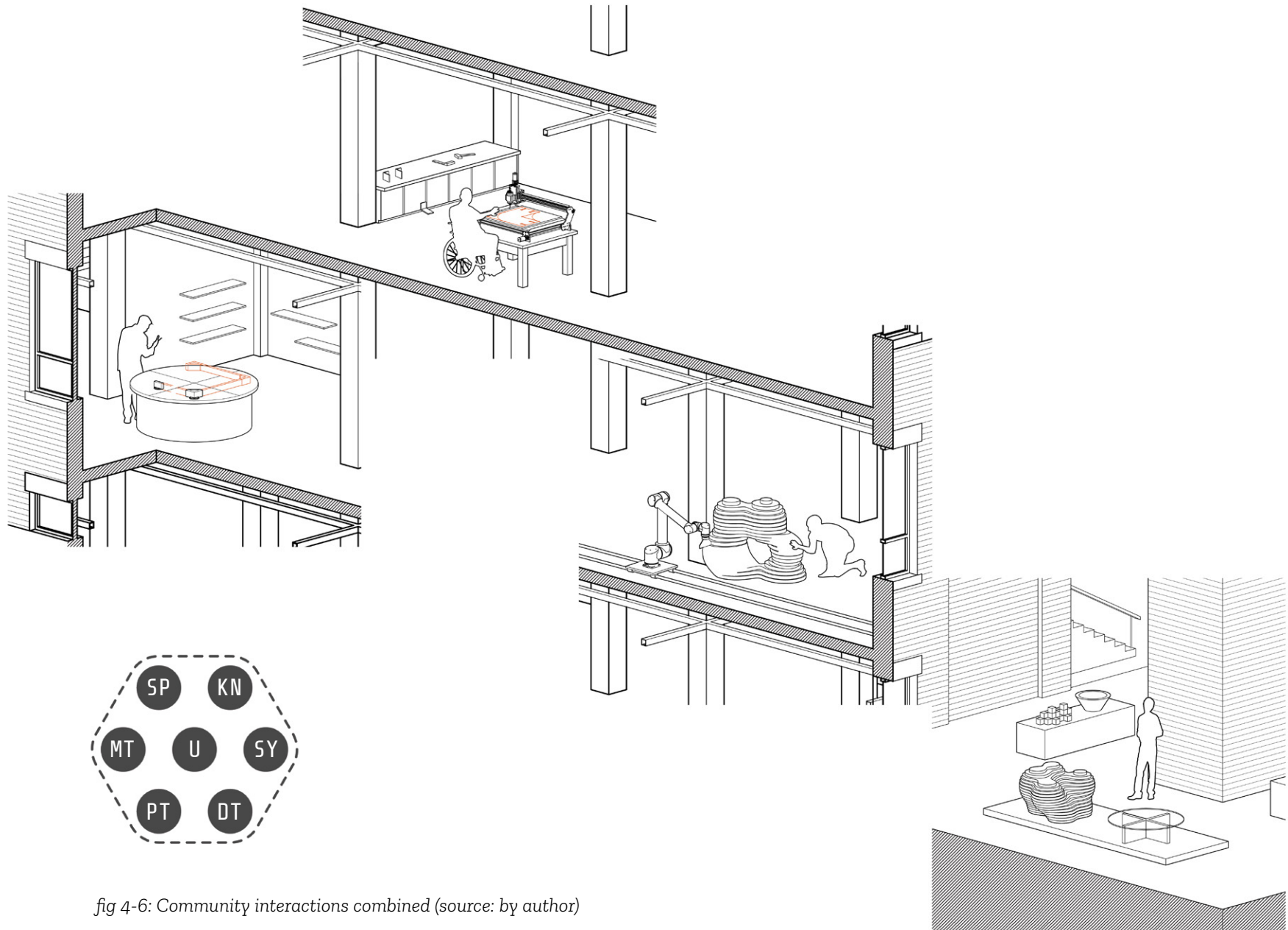

fig 4-6: Community interactions combined (source: by author)

## CONCLUSION:

We are still quite far from these communities I have illustrated, of makers that are empowered, self-sufficient, and interconnected. Many believe that people will be completely replaced in the fields of design and fabrication because of the advances in technologies such as artificial intelligence and robotics. However, I think that as long as there is means of communication between human and machine, these technologies can be used to amplify all of our uniquely human abilities. With the proper interfaces, these technologies can give us more freedom and opportunity.

I hope that the prototypes I have made will excite potential new makers about their undiscovered ability to create something useful and unique. I also hope that it will encourage other designers to create, improve, and share these interface tools. I will undoubtedly continue to learn and create, but now with a greater appreciation for the importance of facilitating creation for others as well.

Digital fabrication tools and networking technology applied correctly already have the ability to improve the lives of individuals and small communities. With enough people involved in an ecosystem such as the *fabrication commons*, this movement of creation and collaboration has the possibility of becoming an alternative cultural and economic model that could undermine and even rival capitalism.

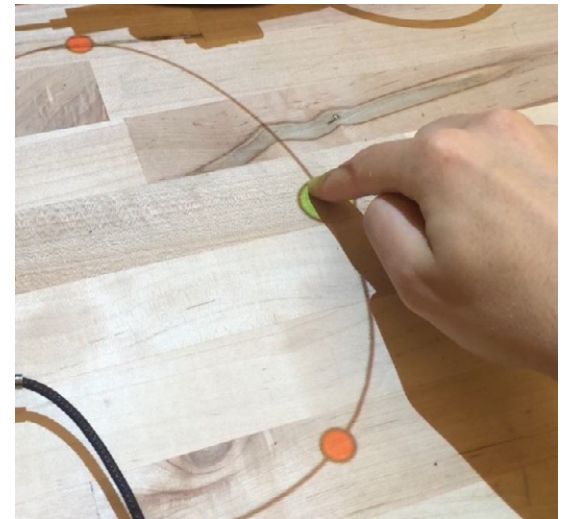
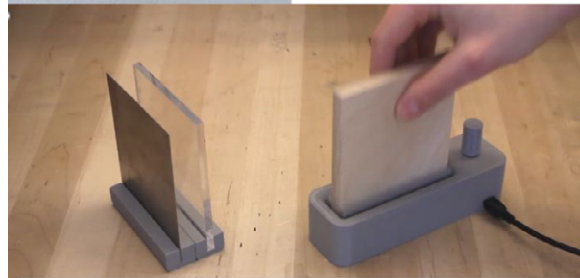
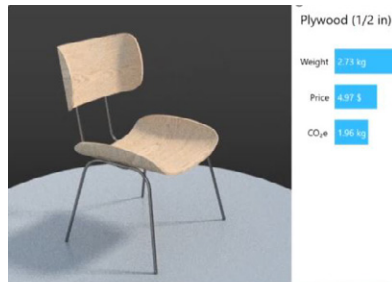
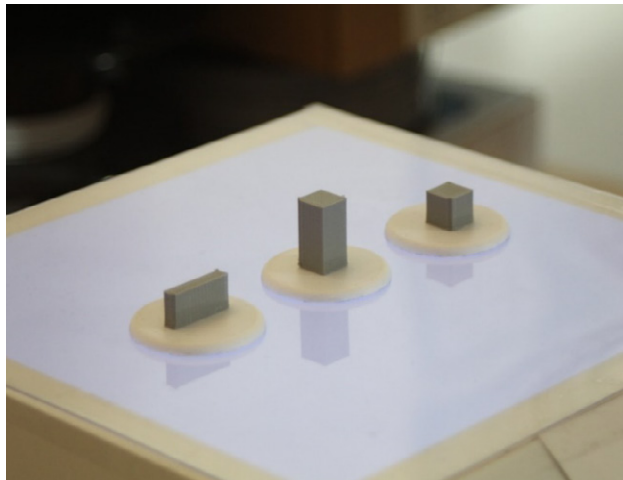

fig 4-7: All prototypes (source: by author)

## Bibliography

Alptekinoğlu, Aydın, and Charles J. Corbett. "Mass Customization vs. Mass Production: Variety and Price Competition." *Manufacturing & Service Operations Management*, vol. 10, no. 2, Apr. 2008, pp. 204–217, 10.1287/msom.1070.0155.

Arnstein, Sherry R. "A Ladder of Citizen Participation." *Journal of the American Planning Association*, vol. 85, no. 1, 2 Jan. 2019, pp. 24–34, 10.1080/01944363.2018.1559388.

Batliner, Curime, et al. "Robot UI." *Robotic Fabrication in Architecture, Art and Design 2016*, vol. 2016, 2016, pp. 376–387, 10.1007/978-3-319-26378-6\_30. Accessed 11 May 2020.

Bard, J., Gannon, M., Jacobson-Weaver, Z., Jeffers, M., Smith, B., & Contreras, M. (2014). Seeing is doing: Synthetic tools for robotically augmented fabrication in high-skill domains. *ACADIA 2014: Design Agency*, 409.

Carmo, Mario. *The Alphabet and the Algorithm*. Cambridge, Ma, Mit Press, 2011.

---. *The Second Digital Turn Design Beyond Intelligence*. Cambridge, Massachusetts; London, England The Mit Press, 2017, muse.jhu.edu/book/56304.

Collier, Ann Futterman, and Heidi A. Wayment. "Psychological Benefits of the 'Maker' or Do-It-Yourself Movement in Young Adults: A Pathway Towards Subjective Well-Being." *Journal of Happiness Studies*, vol. 19, no. 4, 15 Mar. 2017, pp. 1217–1239, 10.1007/s10902-017-9866-x.

Chaltiel, S., Bravo, M., & Chronis, A. (2017). Digital fabrication with virtual and augmented reality for monolithic shells. *ECAADe 2017: Shock!*, 2, 211.

Daas, Mahesh, and Andrew John Wit. *Towards a Robotic Architecture*. ORO Editions, 1 Feb. 2018.

Douglas, Gordon C.C. *The Help-Yourself City: Legitimacy and Inequality in DIY Urbanism*. Oxford University Press, 1 Feb. 2018.

Dubor, Alexandre, et al. "Sensors and Workflow Evolutions: Developing a Framework for Instant Robotic Toolpath Revision." *Robotic Fabrication in Architecture, Art and Design 2016*, vol. 2016, 2016, pp. 410–425, 10.1007/978-3-319-26378-6\_33. Accessed 11 May 2020.

Elashry, Khaled, and Ruairi Glynn. "An Approach to Automated Construction Using Adaptive Programming." *Robotic Fabrication in Architecture, Art and Design 2014*, vol. 2014, 2014, pp. 51–66, 10.1007/978-3-319-04663-1\_4. Accessed 11 May 2020.

Fox, Michael, and Miles Kemp. *Interactive Architecture*. New York, Princeton Architectural Press, 2009.

Fries-Briggs, Gabriel. "Mediating Volumetric Thresholds." *Robotic Fabrication in Architecture, Art and Design 2014*, vol. 2014, 2014, pp. 211–221, 10.1007/978-3-319-04663-1\_14. Accessed 11 May 2020.

Gershenfeld, Neil A. *Fab : The Coming Revolution on Your Desktop--from Personal Computers to Personal Fabrication*. Basic Books, 6 Feb. 2007.

Gannon, M. (2014). Reverberating across the divide: Bridging virtual and physical context in digital design and fabrication. *ACADIA 2014: Design Agency*, 357.

Glass, Tamie. Prompt: Socially Engaging Objects and Environments. Birkhauser, 25 June 2018.

Gornig, Martin, and Jan Goebel. "Deindustrialisation and the Polarisation of Household Incomes: The Example of Urban Agglomerations in Germany." *Urban Studies*, vol. 55, no. 4, 20 Sept. 2016, pp. 790–806, 10.1177/0042098016669285.

Greenfield, Adam. *Radical Technologies : The Design of Everyday Life*. London ; New York, Verso, 2018.

Hatch, Mark. *The Maker Movement Manifesto: Rules for Innovation in the New World of Crafters, Hackers, and Tinkerers*. McGraw-Hill, Sept. 2013.

He, Yu, and Shengyong Chen. "Advances in Sensing and Processing Methods for Three-Dimensional Robot Vision." *International Journal of Advanced Robotic Systems*, vol. 15, no. 2, Mar. 2018, p. 172988141876062, 10.1177/1729881418760623.

Jencks, Christopher, and Nathan Silver. *Adhocism : The Case for Improvisation*. London, Secker And Warburg, 1972.

Jessel, Ella. "Architect Arrested after Chaining Himself to Plywood Tower at XR Demo." *Architects Journal*, 16 Oct. 2019, [www.architectsjournal.co.uk/news/architect-arrested-after-chaining-himself-to-plywood-tower-at-xr-demo/10044842.article](http://www.architectsjournal.co.uk/news/architect-arrested-after-chaining-himself-to-plywood-tower-at-xr-demo/10044842.article). Accessed 17 May 2020.

Kieran, Stephen, and James Timberlake. *Refabricating Architecture : How Manufacturing Methodologies Are Poised to Transform Building Construction*. New York, Mcgraw-Hill, 2004.

Lasi, Heiner, et al. "Industry 4.0." *Business & Information Systems Engineering*, vol. 6, no. 4, 19 June 2014, pp. 239–242, 10.1007/s12599-014-0334-4.

Melcher, Katherine, et al. *Community-Built: Art, Construction, Preservation, and Place*. Routledge, 25 Nov. 2016.

Ostrom, Elinor. *Governing the Commons : The Evolutions of Institutions for Collective Action*. Cambridge, Cambridge University Press, 1993.

Peng, H., Briggs, J., Wang, C., Guo, K., Kider, J., Mueller, S., et al. (2018). RoMA: Interactive Fabrication with augmented reality and a robotic 3D printer. *Chi 2018*, Paper 579

Rifkin, Jeremy. *The Zero Marginal Cost Society : The Internet of Things, the Collaborative Commons, and the Eclipse of Capitalism*. New York, St. Martin's Griffin, 2015.

Schwartz, Thibault, et al. "Towards On-Site Collaborative Robotics." *Robotic Fabrication in Architecture, Art and Design 2016*, vol. 2016, 2016, pp. 388–397, 10.1007/978-3-319-26378-6\_31. Accessed 11 May 2020.

Sharif, Shani, et al. *Adaptive Industrial Robot Control for Designers*. 20 Sept. 2017.

Shebani, A.N., et al. "The Effect of Wood Species on the Mechanical and Thermal Properties of Wood—LLDPE Composites." *Journal of Composite Materials*, vol. 43, no. 11, 26 May 2009, pp. 1305–1318, 10.1177/0021998308104548.

Sheridan, Kimberly, et al. "Learning in the Making: A Comparative Case Study of Three Makerspaces." *Harvard Educational Review*, vol. 84, no. 4, Dec. 2014, pp. 505–531, 10.17763/haer.84.4.brr34733723j648u.

Vercruyssen, Emmanuel, et al. "Instruction and Instinct." *Robotic Fabrication in Architecture, Art and Design 2014*, vol. 2014, 2014, pp. 223–231, 10.1007/978-3-319-04663-1\_15. Accessed 11 May 2020.

## APPENDIX: Prototype Resources and Instructions

### Prototype 1 - Collaborative Creation

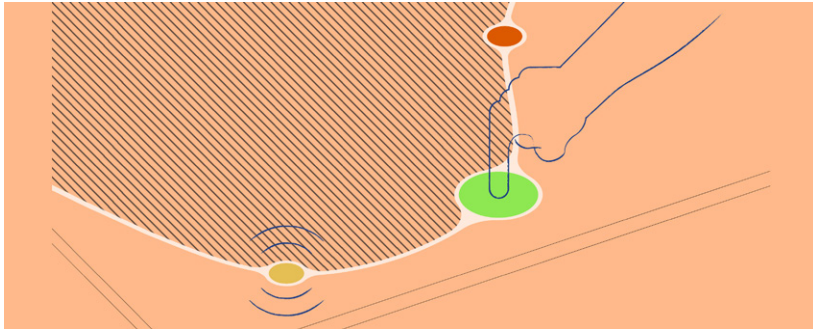

To download all digital resources and see more photos/videos, visit: <http://agontarz.com/p01/>

#### Tools/Materials Needed:

- Projector
- Leap Motion finger tracker
- Material Surface

#### Instructions:

1. Download the Human UI and Firefly plugins for grasshopper, and open the grasshopper script
2. Mount and connect the finger tracker, and make sure it is streaming data to the script
3. Mount and connect the projector, and line up the HumanUI window in the image
4. Calibrate the tracking to the image by moving the sliders until both are aligned

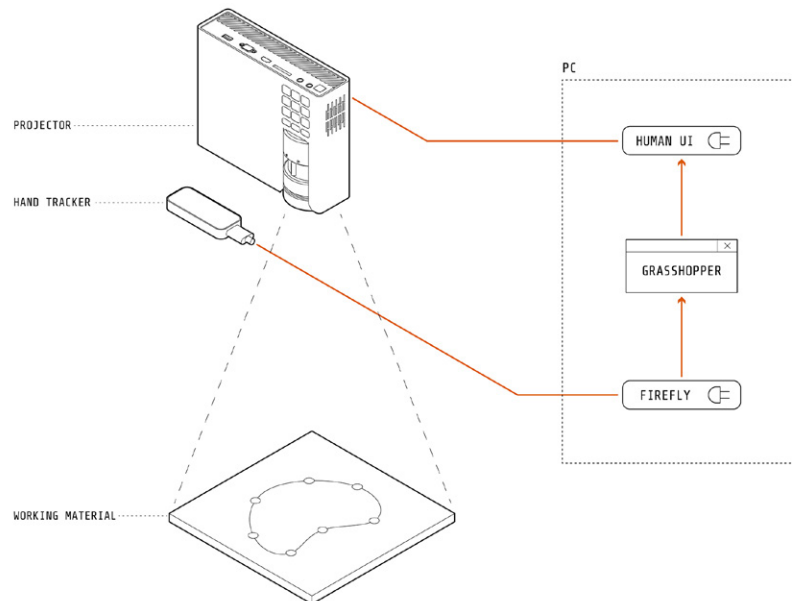



## Prototype 2 - Custom Materials

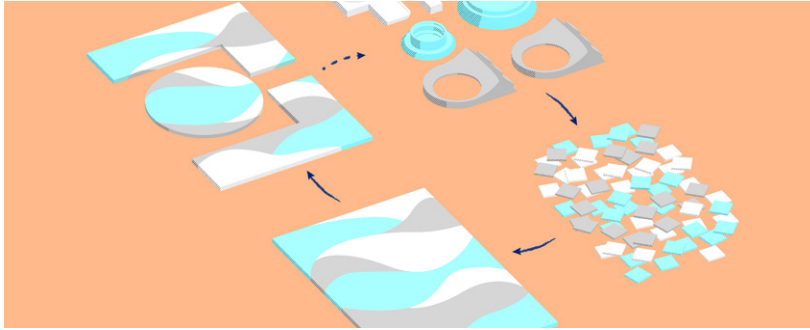

To download all digital resources and see more photos/videos, visit: <http://agontarz.com/po2/>



### Tools/Materials Needed:

- Failed 3D Prints
- Old toaster oven
- Baking pan
- Baking sheets
- Pressing Jig/Device

### Instructions:

1. Shred failed prints into consistent pieces (size can vary and will affect the quality of the final sheet). Use a heavy duty shredder or hand tools
2. Place baking sheet on pan, making sure to cover the sides
3. Mix desired mixture of coloured chips and place on pan.
4. Heat oven and place tray inside (195 deg C for 10-15 minutes is reliable)
5. Remove pan, then remove plastic by holding the baking sheet. Cover with another baking sheet and place in press. Press down until cooled.

## Prototype 3 - Open Construction Kit

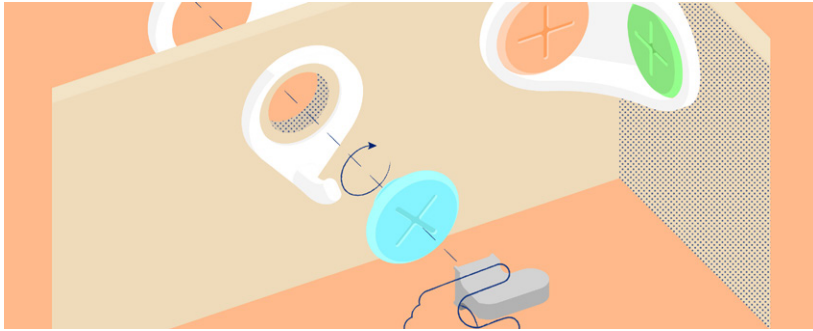

To download all digital resources and see more photos/videos, visit: <http://agontarz.com/p03/>

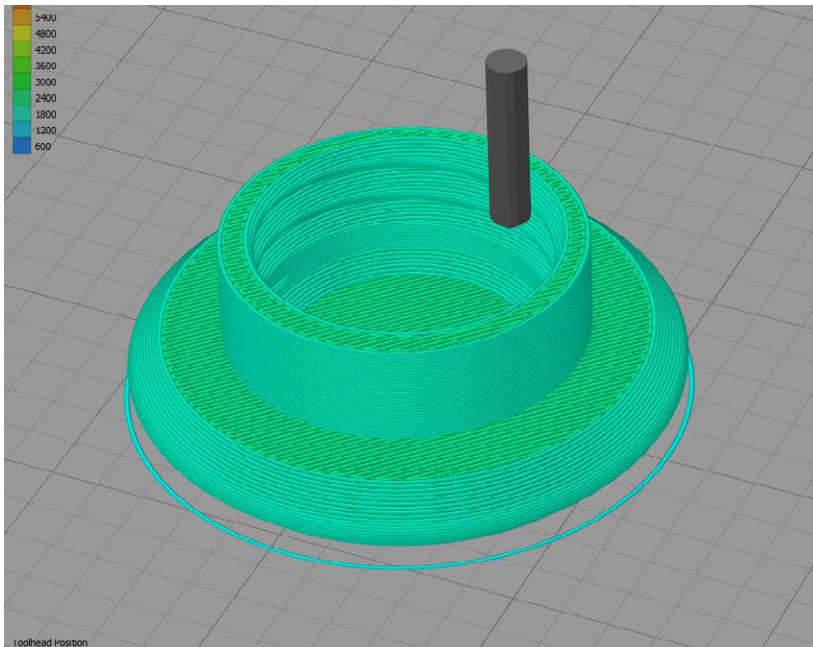

### Tools/Materials Needed:

- 3D printer
- Drill
- 1-1/4" Hole cutter
- Scrap Sheet Material (eg. plywood)

### Instructions:

1. Print the desired pieces at 100% infill with no supports, with a 0.4mm or 0.6mm nozzle.
2. Print two tightening keys
3. Use hole cutter to cut plywood in the desired locations for connections
4. Screw together the two button pieces with any attachments in between and tighten
5. Design and share your own modifications

## Prototype 4 - Smart Material Library

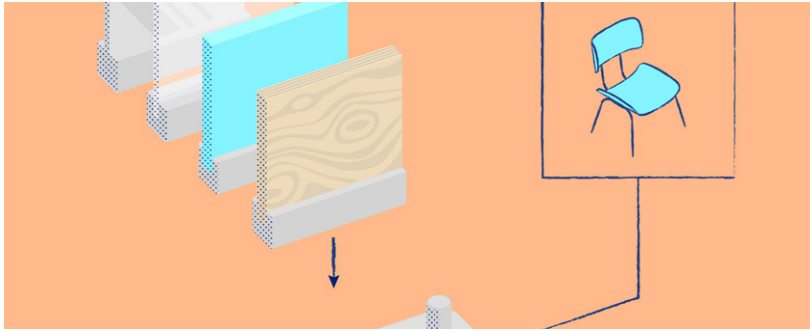

To download all digital resources and see more photos/ videos, visit: <http://agontarz.com/po4/>

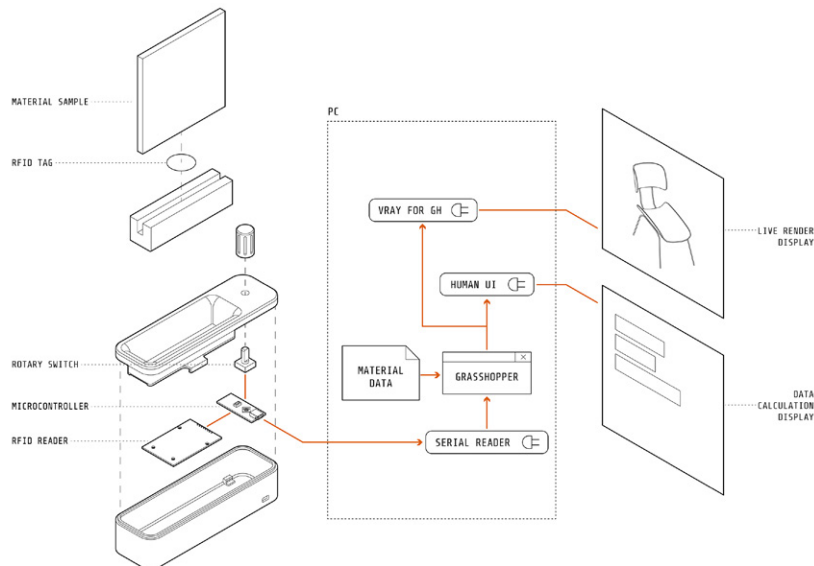

### Tools/Materials Needed:

- 3D Printer and filament
- Arduino nano
- RFID Reader
- RFID Tags
- Rotary Encoder
- Material Samples

### Instructions:

1. 3D print the enclosure at 100% infill, and the sample holders at 50% infill.
2. Wire together the Arduino, RFID reader and rotary encoder, then snap into the enclosure
3. Slide the material samples into the sample holders with an RFID tag in between
4. Upload the Arduino sketch to the Arduino
5. Download the Human UI and Firefly plugins for grasshopper
6. Run the grasshopper script, and make sure the arduino is connected to it by serial port
7. Add the data for the correct material to the .csv spreadsheet and link the proper textures

## Prototype 5 - Tactile Designer

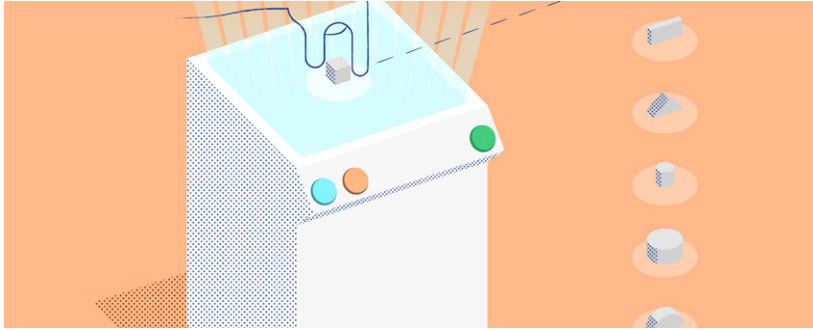

To download all digital resources and see more photos/videos, visit: <http://agontarz.com/p05/>

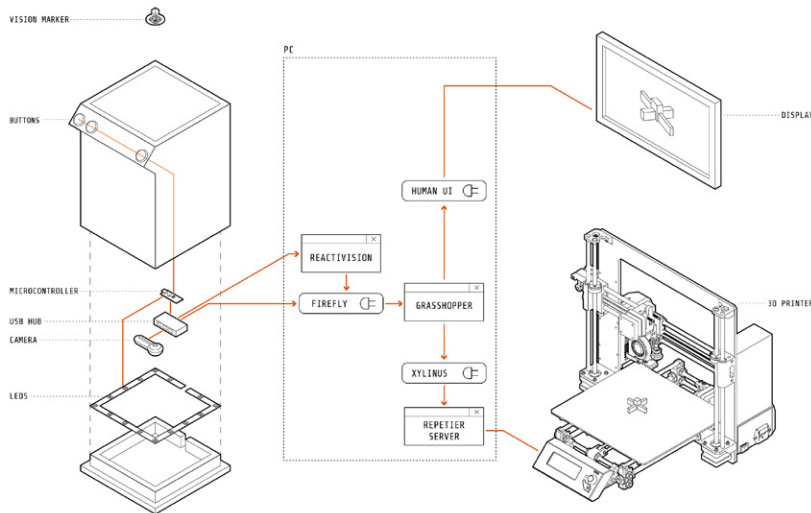

### Tools/Materials Needed:

- Foam Core
- Plexiglass
- 3D Printer and filament
- Webcam
- Arduino Nano
- USB Hub
- LEDs
- Buttons

### Instructions:

1. Build a box with an open top out of foamcore. Cover top with frosted plexiglass
2. Place the webcam, arduino, and USB hub at the base of the box
3. Wire buttons and LEDs to the arduino, connect everything to the USB hub, and connect to the PC
4. Download Firefly, HumanUI, and Xylinus for grasshopper, and Reactivision software, and markers
5. Print the markers on paper, and 3D print the modules. Tape the markers to the underside.
6. Run the Reactivision software, and make sure it registers the markers on top of the box.
7. Set up Repetier Server for your 3D printer, and enter its information (name, API, etc) in the grasshopper script.

## Prototype 6 - Robotic Coworking

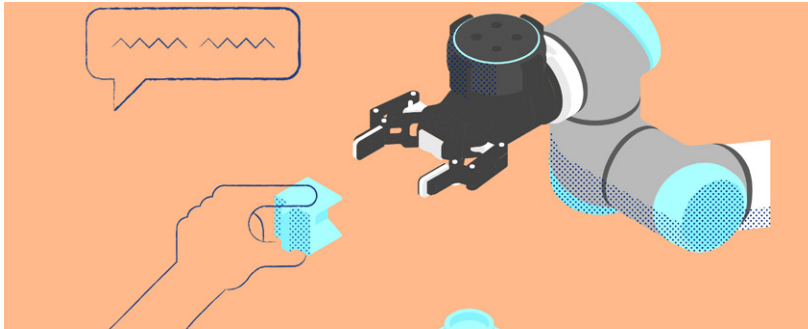

To download all digital resources and see more photos/videos, visit: <http://agontarz.com/po6/>

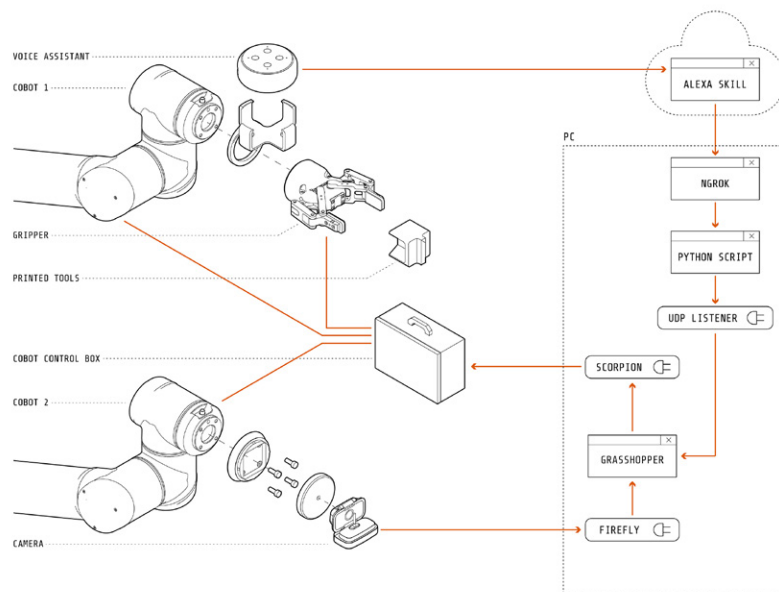

### Tools/Materials Needed:

- Collaborative Robot
- Webcam
- Voice assistant (eg. Alexa)
- 3D Printer and filament
- Clay

### Instructions:

1. 3D print the Alexa and camera mount and the tools that the gripper will hold
2. Download the Scorpion and Firefly plugins for grasshopper
3. Connect your PC to the robot using an ethernet cable. Make sure the IP address matches on both
4. Run the "ngrok" server from the command line
5. Create an Alexa Skill with the online developer tools. Set the phrases you want it to register with "intents", and set the endpoint to the address showing in ngrok
6. Modify the python script with the interaction you want to communicate to the grasshopper script
7. Run the grasshopper script

## APPENDIX: Other Experiments and Drawings

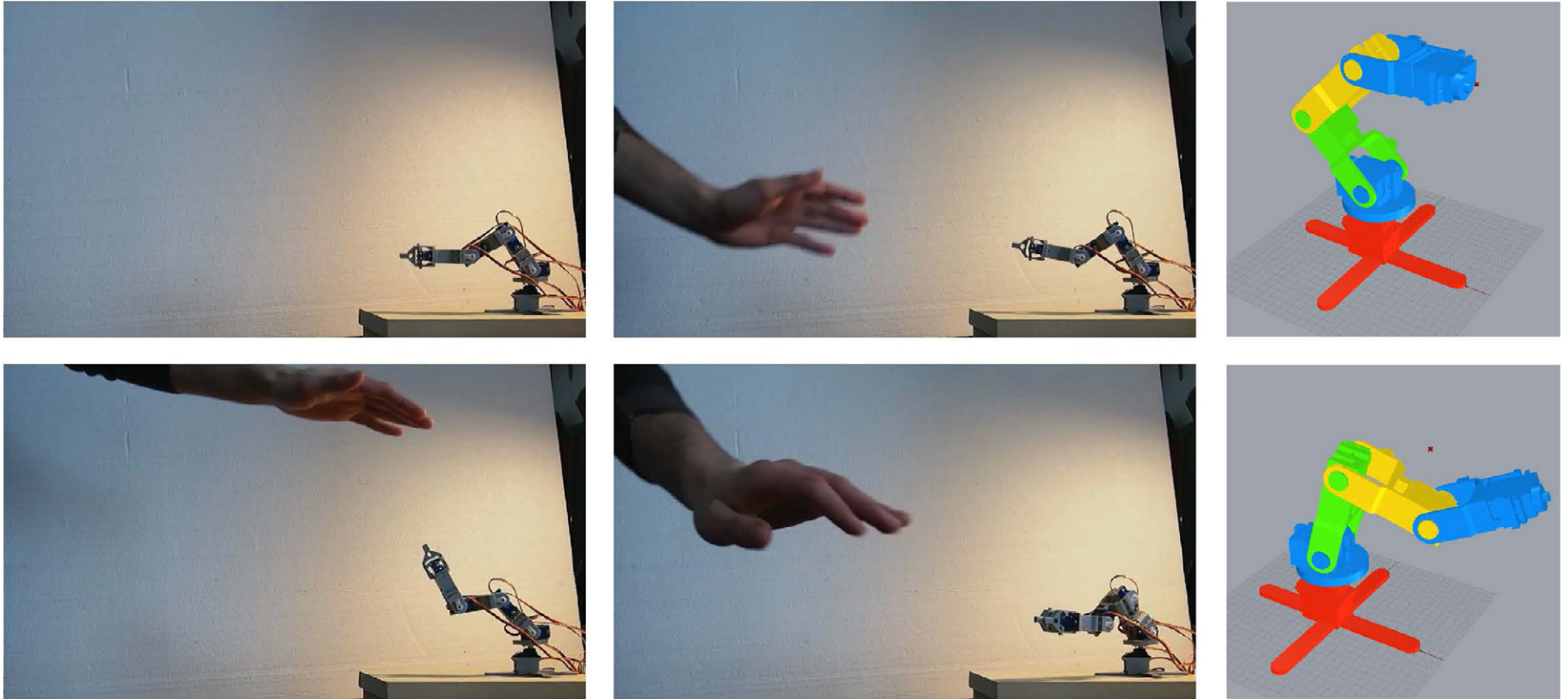

fig A-1: 3d printed robot reacting to body position (source: by author)

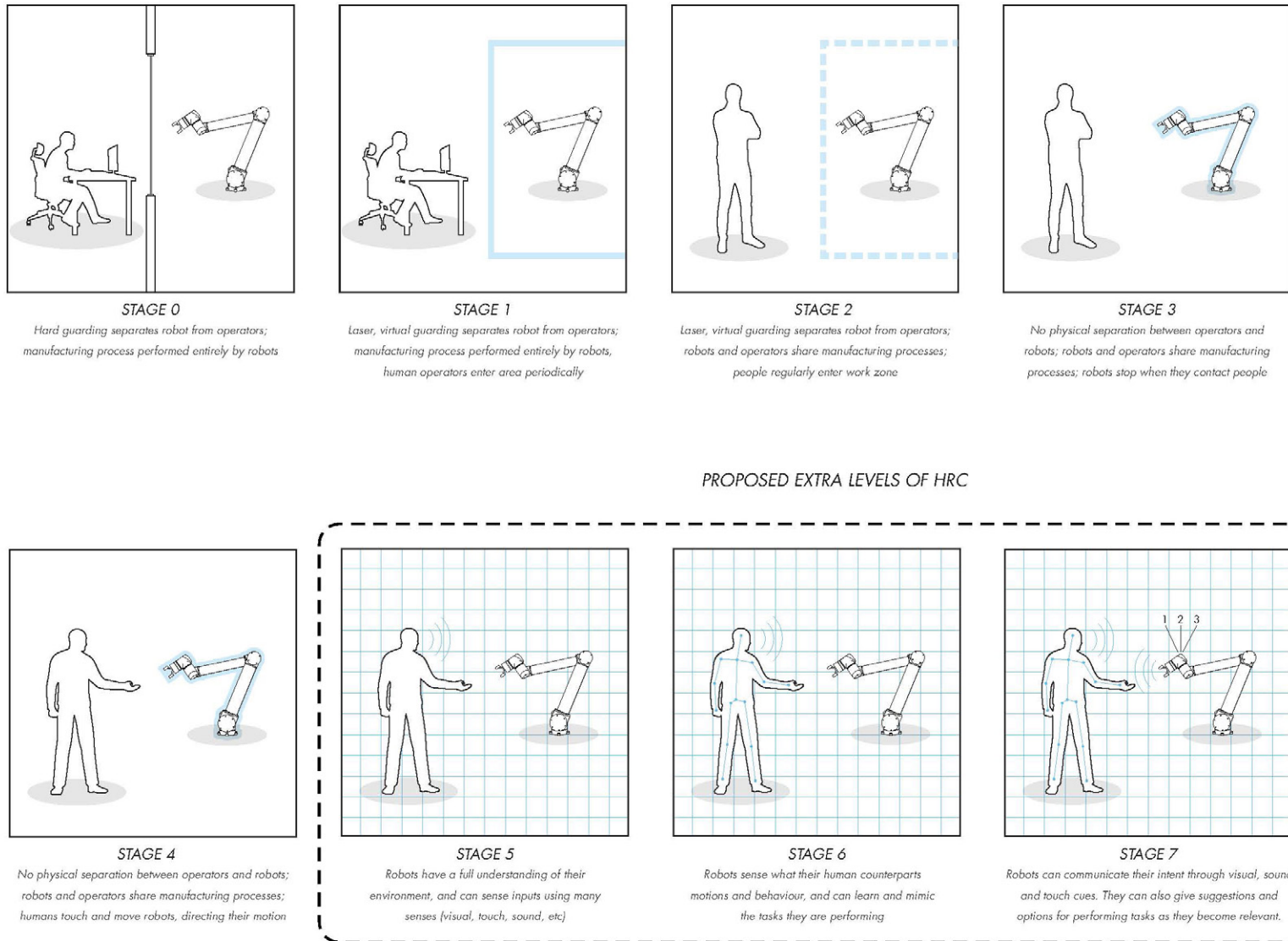

fig A-2: Proposed extra levels of Human-Robot Collaboration (source: by author)

### REIMAGINING TRADITIONAL CRAFT

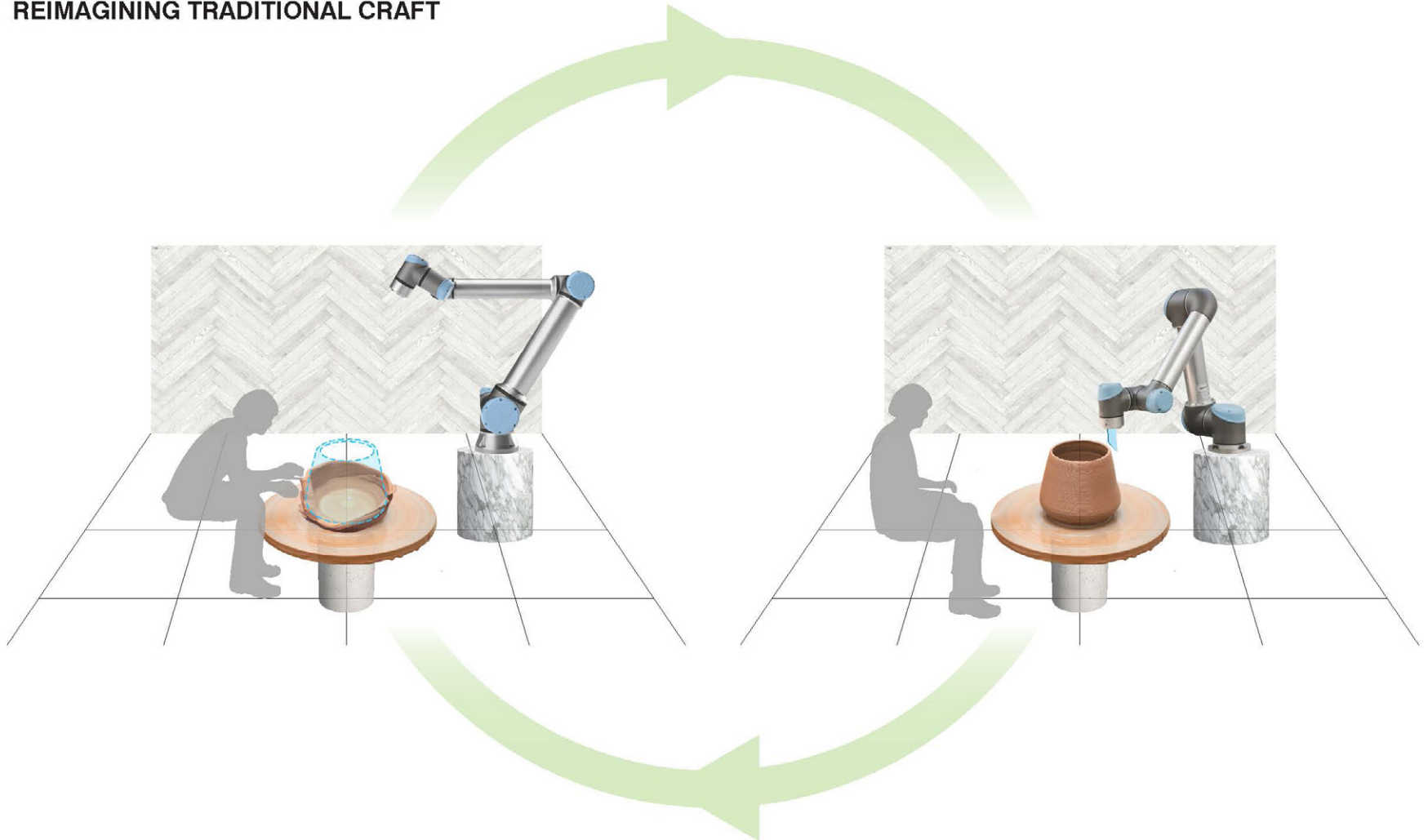

fig A-3: Reimagining traditional craft (source: by author)



SCALE

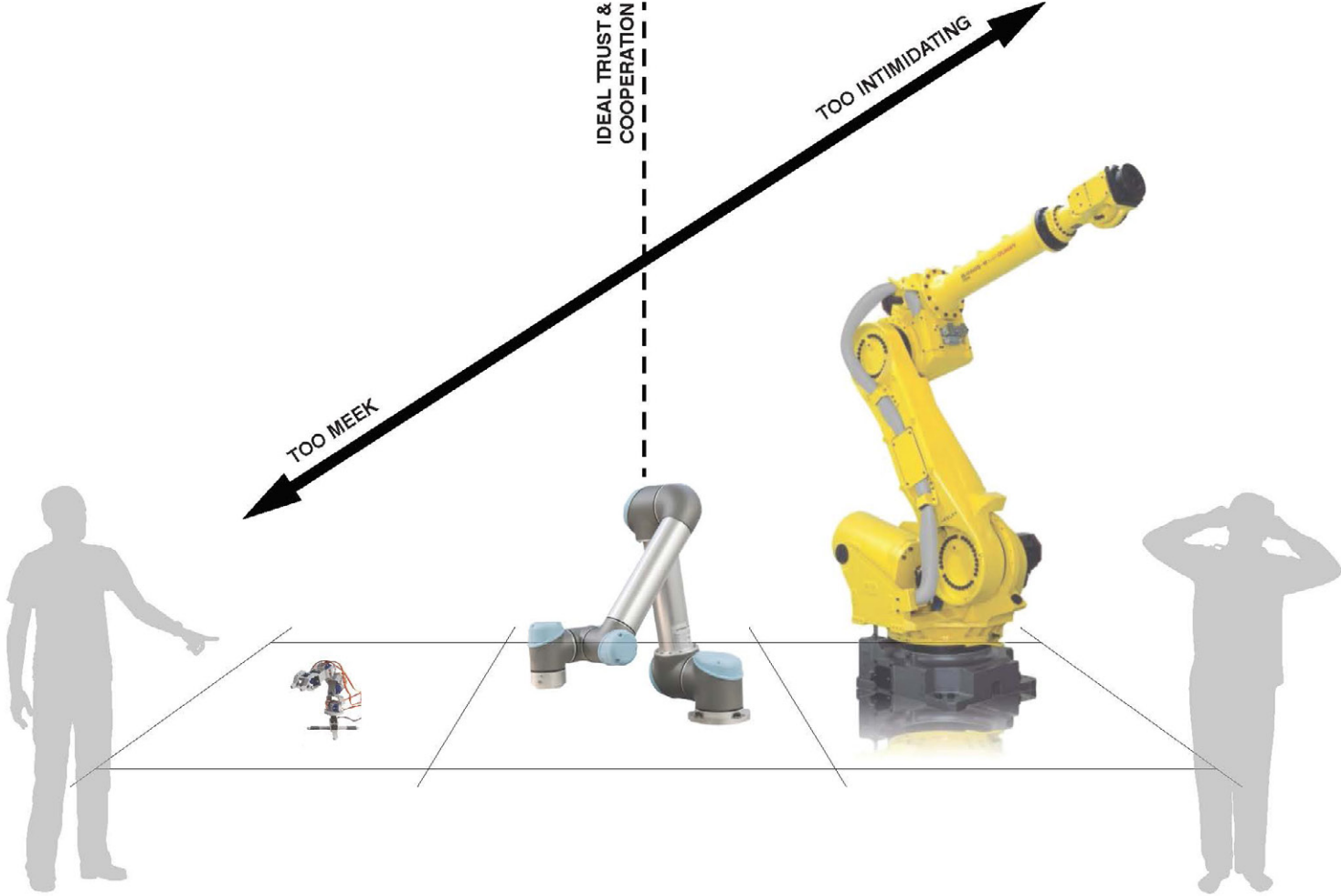

fig A-4: Scale and robotic trust (source: by author)

fig A-5: UR Robot following finger motion in 3d space (source: by author)

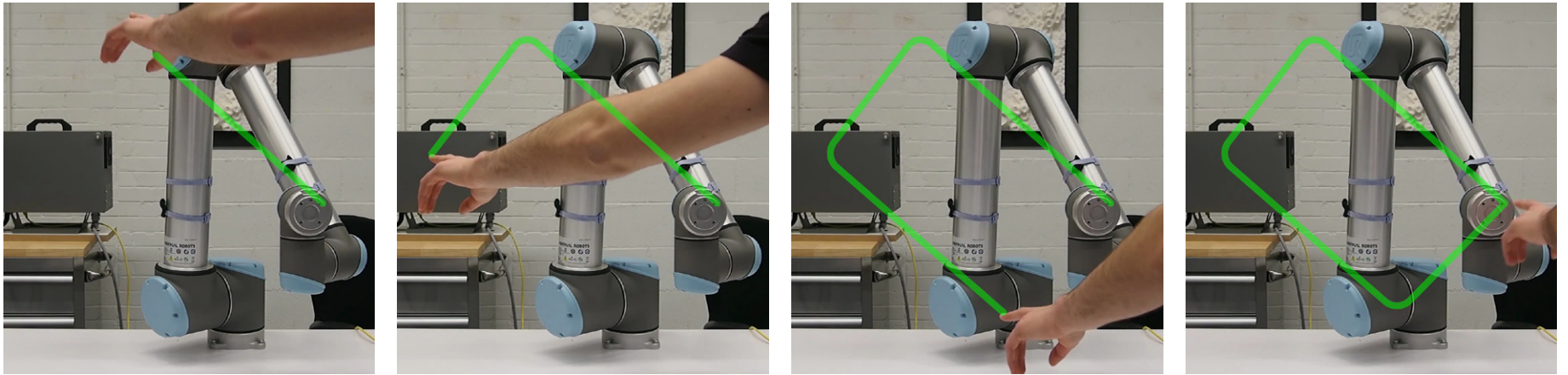

fig A-6: Projection calculating area of boxes (source: by author)



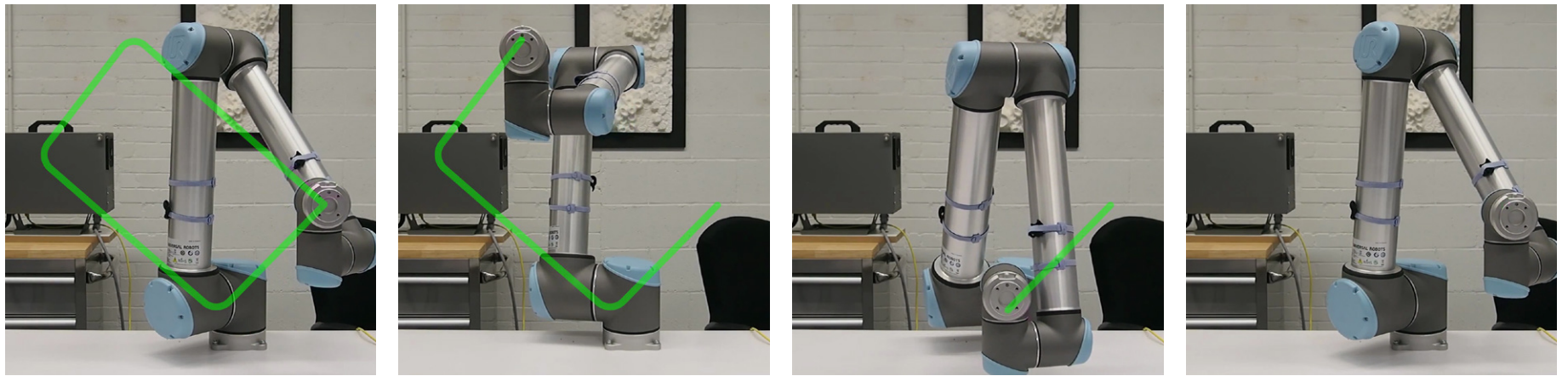
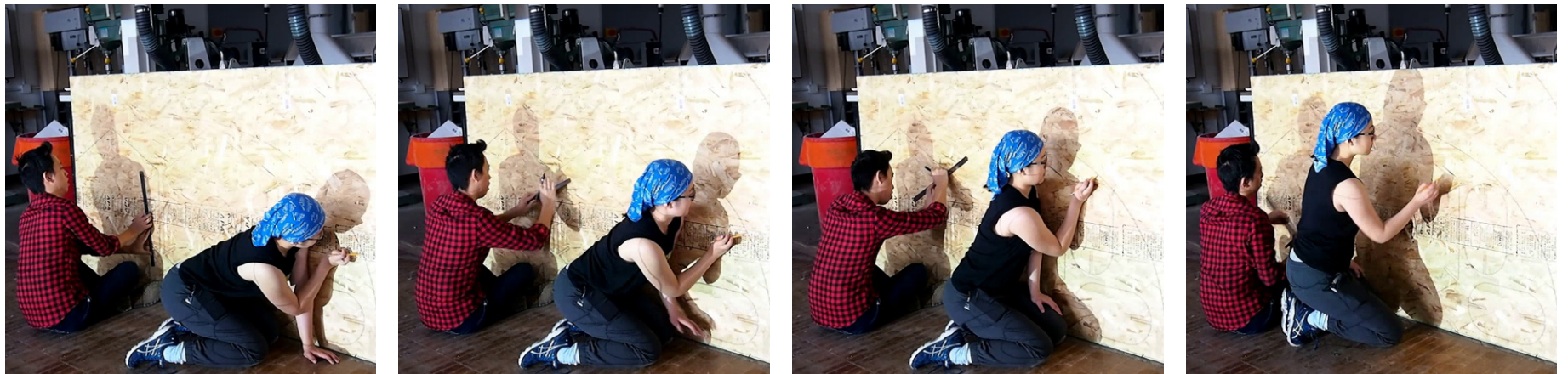

fig A-7: Drawing complex cutting patterns on plywood with projected guides (source: by author)



# Glossary of Terms

## **Accessible**

Capable of being understood and used by people of various backgrounds and abilities, without significant physical or informational resistance.

## **Agency**

The ability of a person to affect their environment with their actions. The amount of influence exerted is a product of the individual's resources and skills. Where multiple parties are involved, there can be a conflict of agencies and compromises must be made.

## **Bottom-Up // Top-Down Design**

Two design strategies that differ in how ideas are developed and organized. Bottom-up is a process-oriented, evolutionary strategy; while top-down is a goal-oriented, extensively planned strategy.

## **Collaborative**

Involving multiple parties working together for a common purpose. The free exchange of knowledge and resources strengthens the collaboration.

## **Commons**

A set of resources contributed to and shared by every person in that community. This can be shared physical and digital space, materials, and information.

## **Cradle to Cradle**

A manufacturing process where every step in the lifetime of a product is taken into consideration. The initial sourcing and end disposal steps can be plugged into existing closed-loop systems.

## **Craft**

An activity that involves making something skillfully and thoughtfully. Traditionally limited to "hand-making", digital craftsmanship can have the same amount of skill and thoughtfulness, but using more advanced tools.

### **Crowd-Sourced**

A model of obtaining goods, services, ideas, or finances from a large group of users that have a stake in the envisioned result. Usually refers to online communities, but crowdsourcing can apply to local communities as well

### **Democratized**

To introduce democratic principles to, or make something accessible to a broader audience.

### **DIY (Do-It-Yourself)**

The activity of making or repairing something, rather than hiring a professional or buying it pre-made.

### **Ecosystem**

A network of interconnected parts or elements, that rely on the interaction between these elements to function optimally.

### **Embedded Computation**

Computer hardware that is designed to perform a specific task relating to the object or space that it is embedded in. These objects or spaces with embedded computation abilities are often connected to each other in a larger network, forming an Internet of Things (IoT)

### **Engaging**

Captivating and attractive. Able to draw and hold someone's attention. Actively inviting passive people to interact and learn.

### **Expert // Non-Expert**

An expert is an experienced person with a particular set of skills and knowledge that pertains to a particular subject. A non-expert is a novice or newcomer to subject. The journey from non-expert to expert is particularly difficult at the beginning because of a lack of context, information, and confidence.

**Fabrication**

The act of crafting or manufacturing a product or piece of an assembly from raw or semi-finished materials

**Facilitator**

Someone that helps another person do or achieve a particular thing, by providing guidance, assistance, or information. This help can be indirect, such as organizing information so that it is accessible, or designing intuitive processes.

**Hacking**

Unconventionally using a predetermined system to come up with a new creative or improvised solution

**Hardware (Assembly)**

In manufacturing, hardware is the standard components of an assembly such as screws or bolts

**Hardware // Software**

In computing, hardware is the physical counterpart and software is the digital counterpart of any electronic device.

**Interface**

A shared boundary where two distinct parts of a systems or parties meet and can exchange information.

**Intuitive**

A mode grounded in intuition: using or operating something based on feelings or initial judgments, rather than learned facts.

**Local // Global**

Local means belonging or relating to a certain area or neighbourhood. This can be in relation to culture, materials, economy, etc. Global, on the other hand, are qualities that are not tied to a geographical location.

**Making (Maker)**

Making is creating, assembling, modifying, fixing, hacking, reclaiming, or re-appropriating. A maker is someone who defines themselves as someone who engages in these activities.

### **Mass-Produced // Mass-Customized**

A mass-produced product is standardized and manufactured in large quantities, often in a linear assembly line. It takes advantage of the economy of scale, where after the large capital investment is recovered, the profits increase with each similar product made. A mass-customized product is one that is unique (or part of a small batch) with each iteration. Modern digital fabrication tools are allowing for the production of mass customized goods with out much loss of efficiency becoming a viable alternative to mass-production.

### **Materials**

The raw matter, parts, components, or assemblies that are consumed or used to form the end product.

### **Open-Source**

Information that is freely available for anyone to use, modify, or enhance. Used mainly to describe software, it can also refer to the designs and resources used to make physical products.

### **Peer-to-peer (P2P)**

A distributed strategy of networking between individuals without the need for a central server. The spirit of P2P includes sharing resources, a lack of hierarchy, and an unobstructed flow of information.

### **Physical // Virtual**

Whether something has material or informational properties. Things that are physical can be interacted with using our senses (touch, sound, smell). Things that are virtual have to be represented (on paper or on a screen) for us to understand. Something that exists in both physical and virtual space simultaneously would be considered to exist in mixed or augmented reality.

### **Producer // Consumer**

A producer is a party or individual that creates products, services, or information for consumers. Every individual is a consumer, but not necessarily a producer, as production has become a centralized process. Individuals contribute to these processes, but rarely have any agency over it.

**Prosumer**

An individual that is a producer as well as a consumer. A prosumer may make products for his or her own use, or collaborate with others to make products shared by the community.

**Resistance**

The forces that obstruct people from accomplishing a goal. Lowering this resistance can relieve frustration, and increase engagement and collaboration.

**Systems**

Groups of items which are organized in a way that aids users reach their desired goal. These can include: toolkits, modules, design libraries, parametric designs.

**Tools**

A physical device or software used to carry out a particular function. Tools are used in most stages of the fabrication workflow, from the initial design, to the finishing of the final product.

**User**

An individual that takes part in the *Fabrication Commons*. They become both a producer and consumer.



*The Fabrication Commons: Creative Agency Through Intuitive Interfaces*